

Aussensäume
3432/70

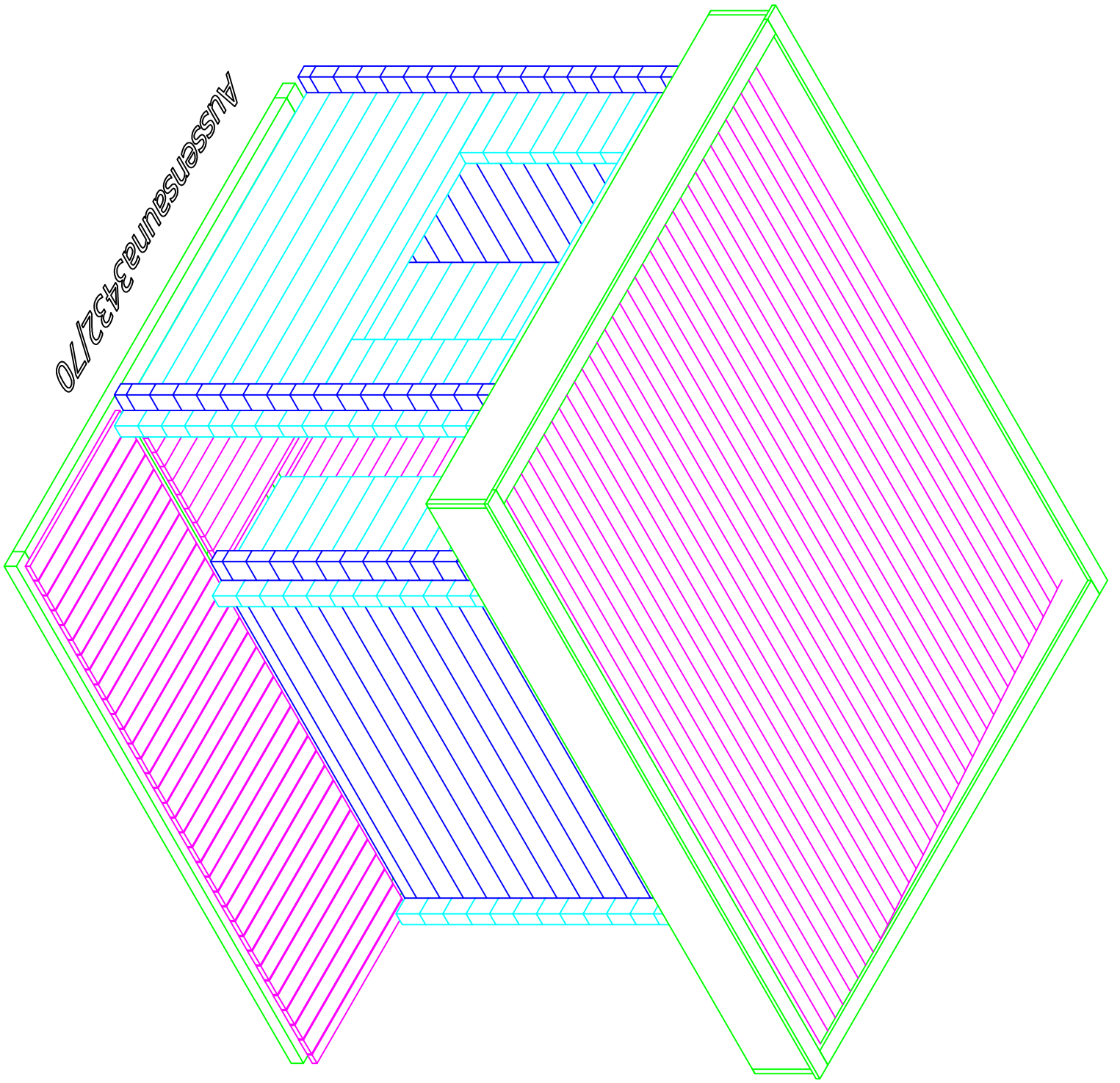

Aussensauna 3432 M / 70 / 2014

2110

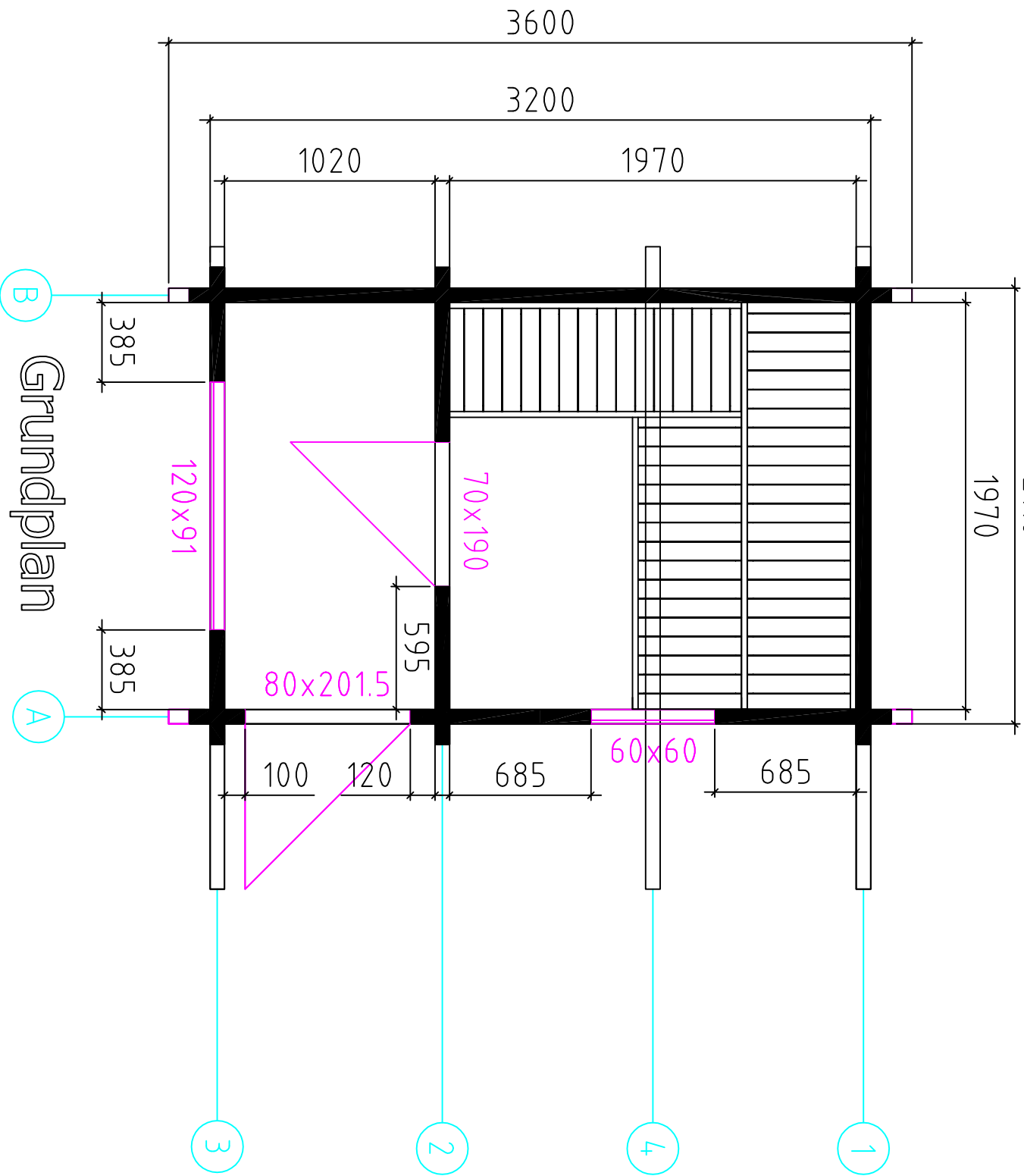

Grundplan

Aussensauna 3432 M / 70 / 2014

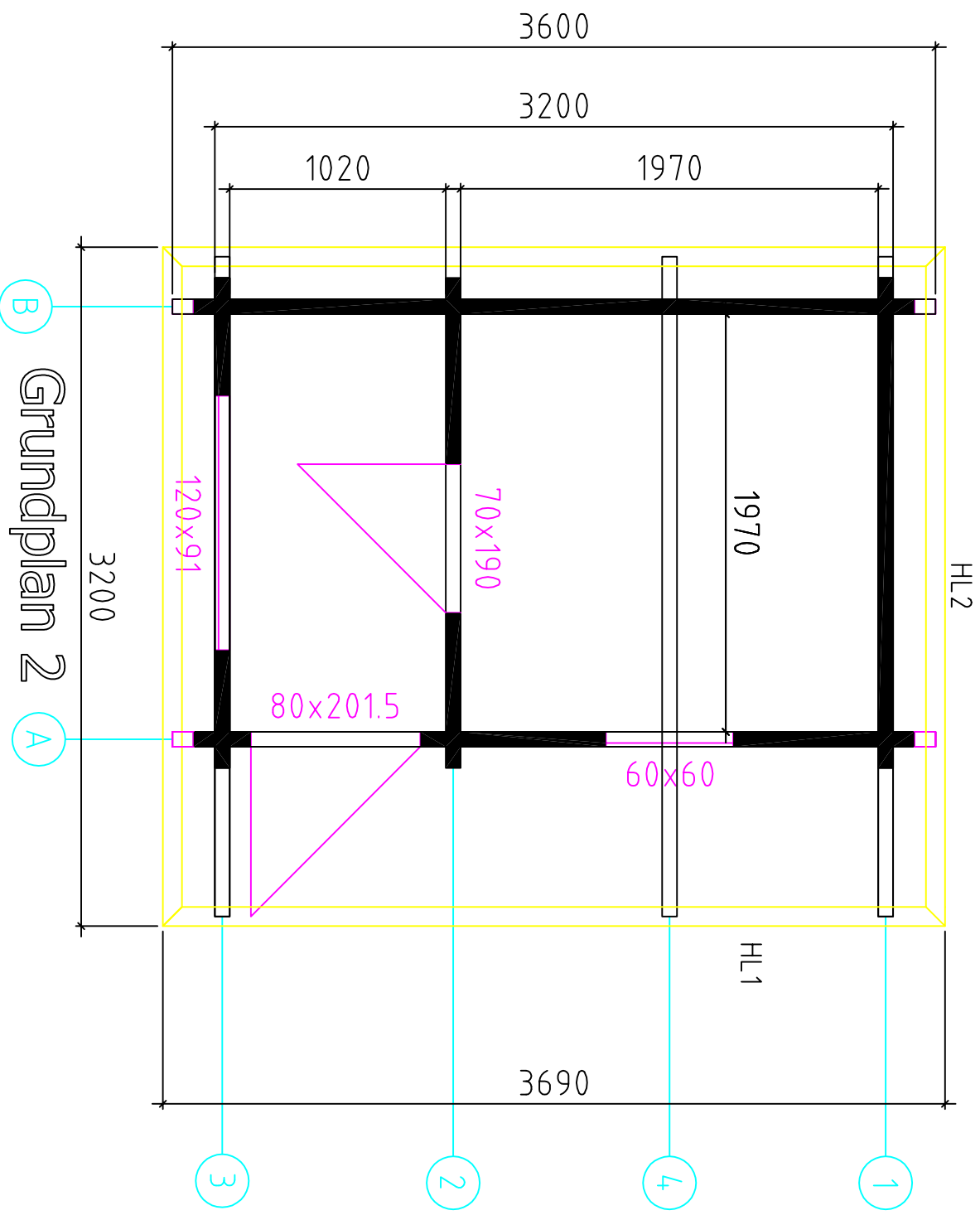

Grundplan 2

Aussensauna 3432 M / 70 / 2014

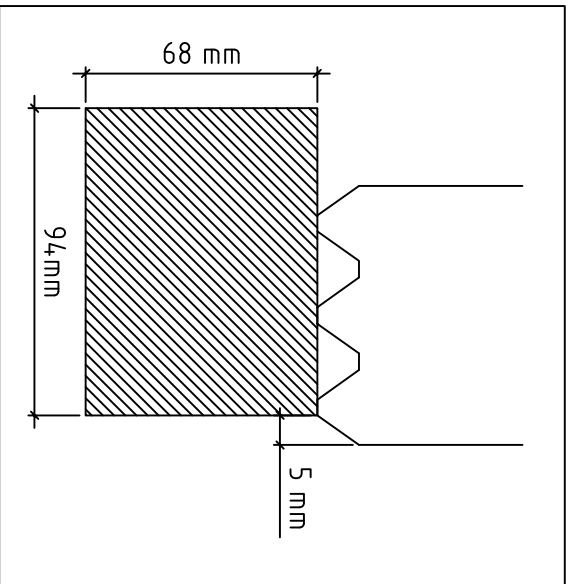
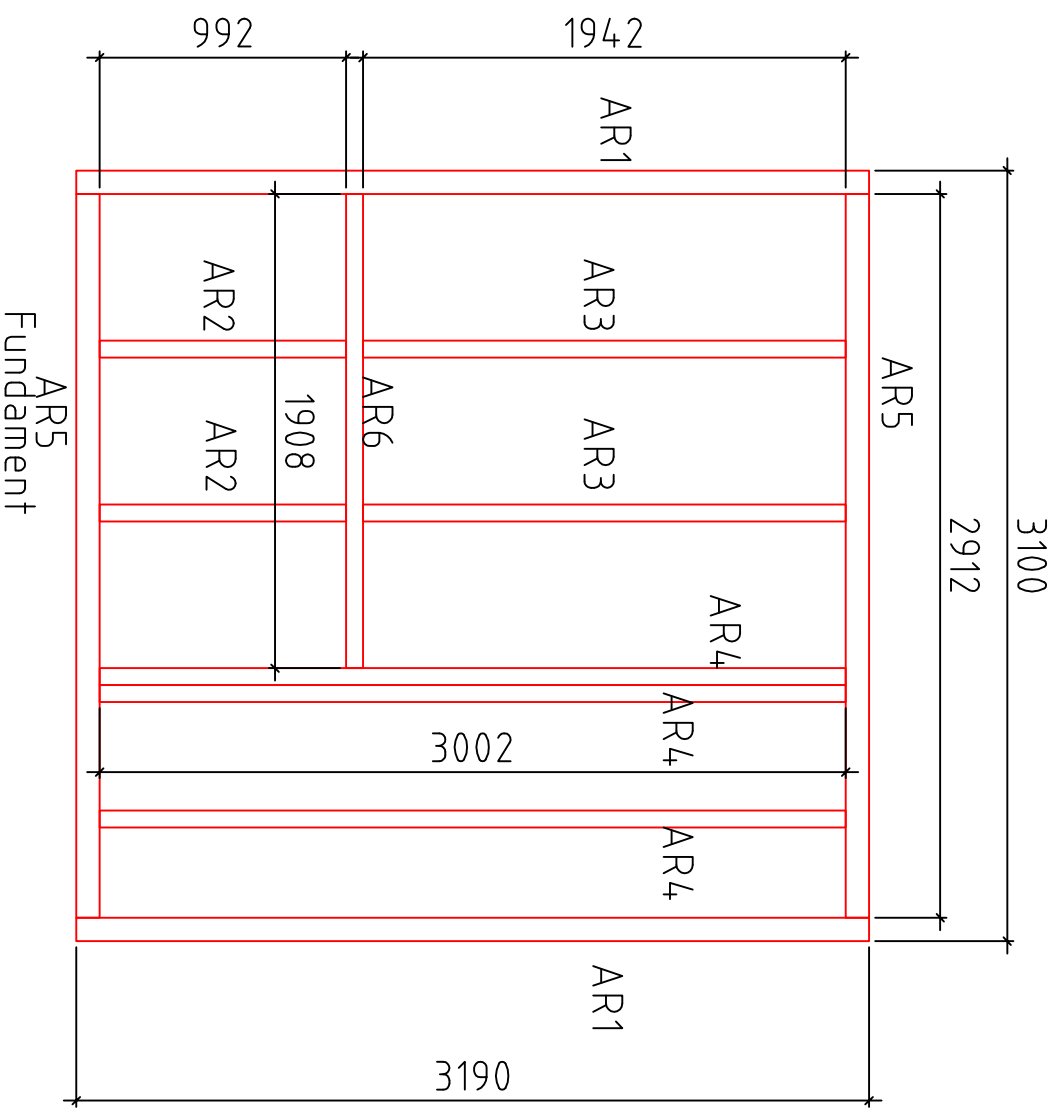

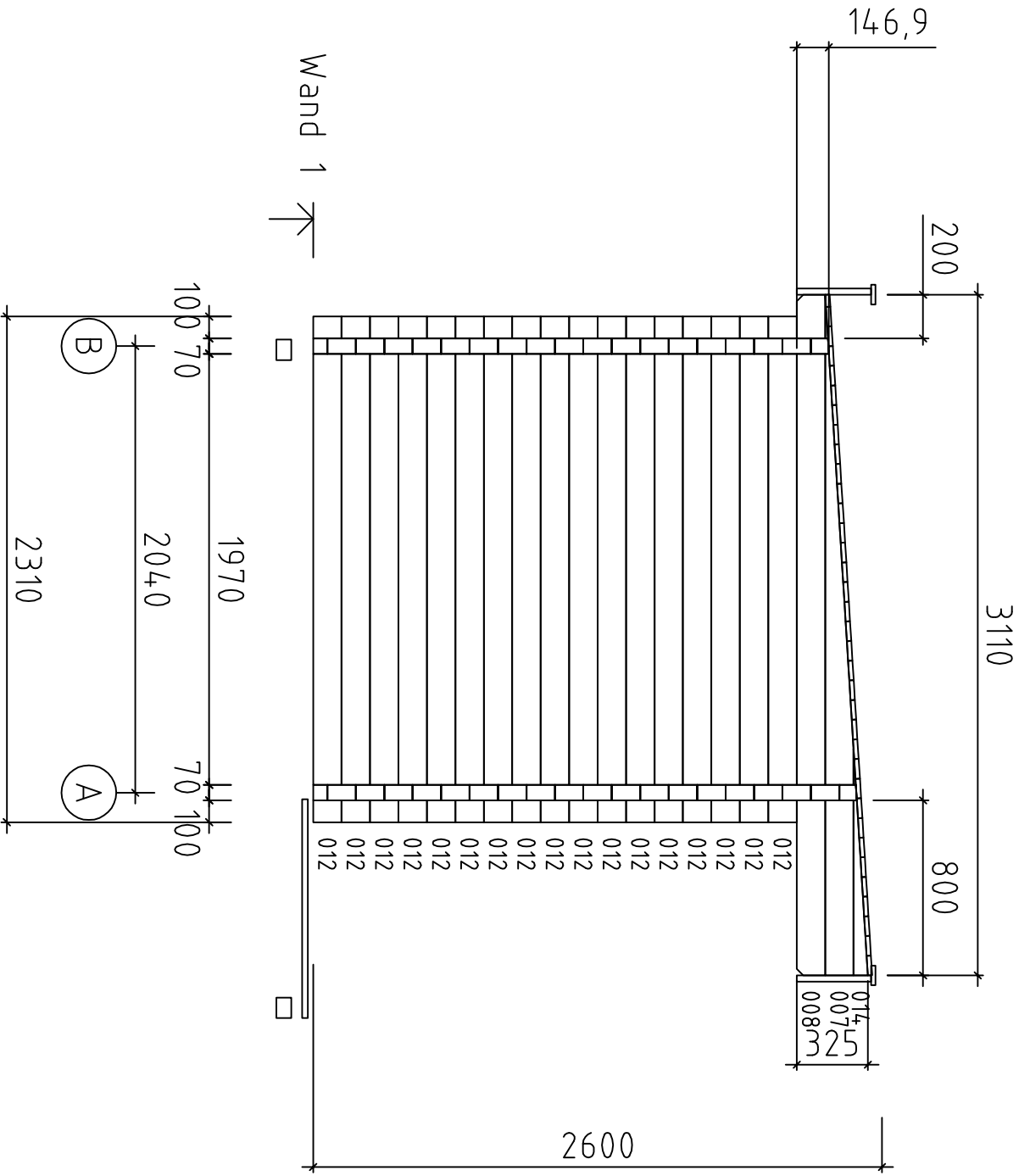

Aussensauna 3432 M / 70 / 2014

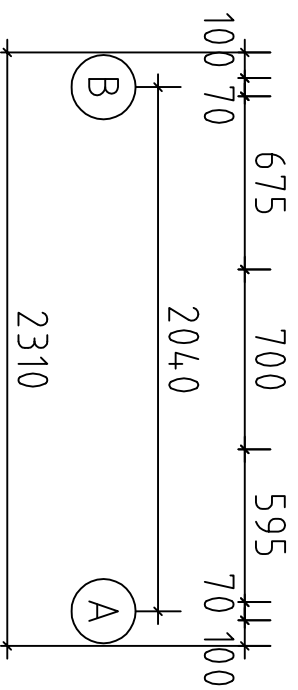
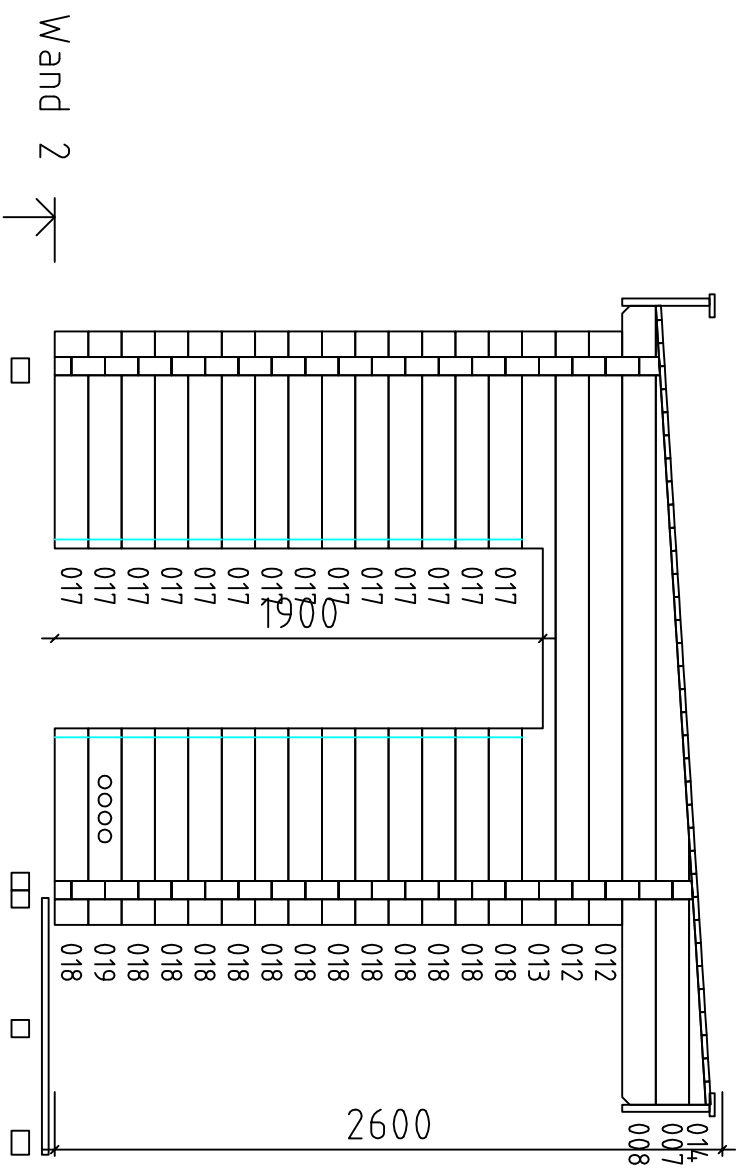

Aussensauna 3432 M / 70 / 2014

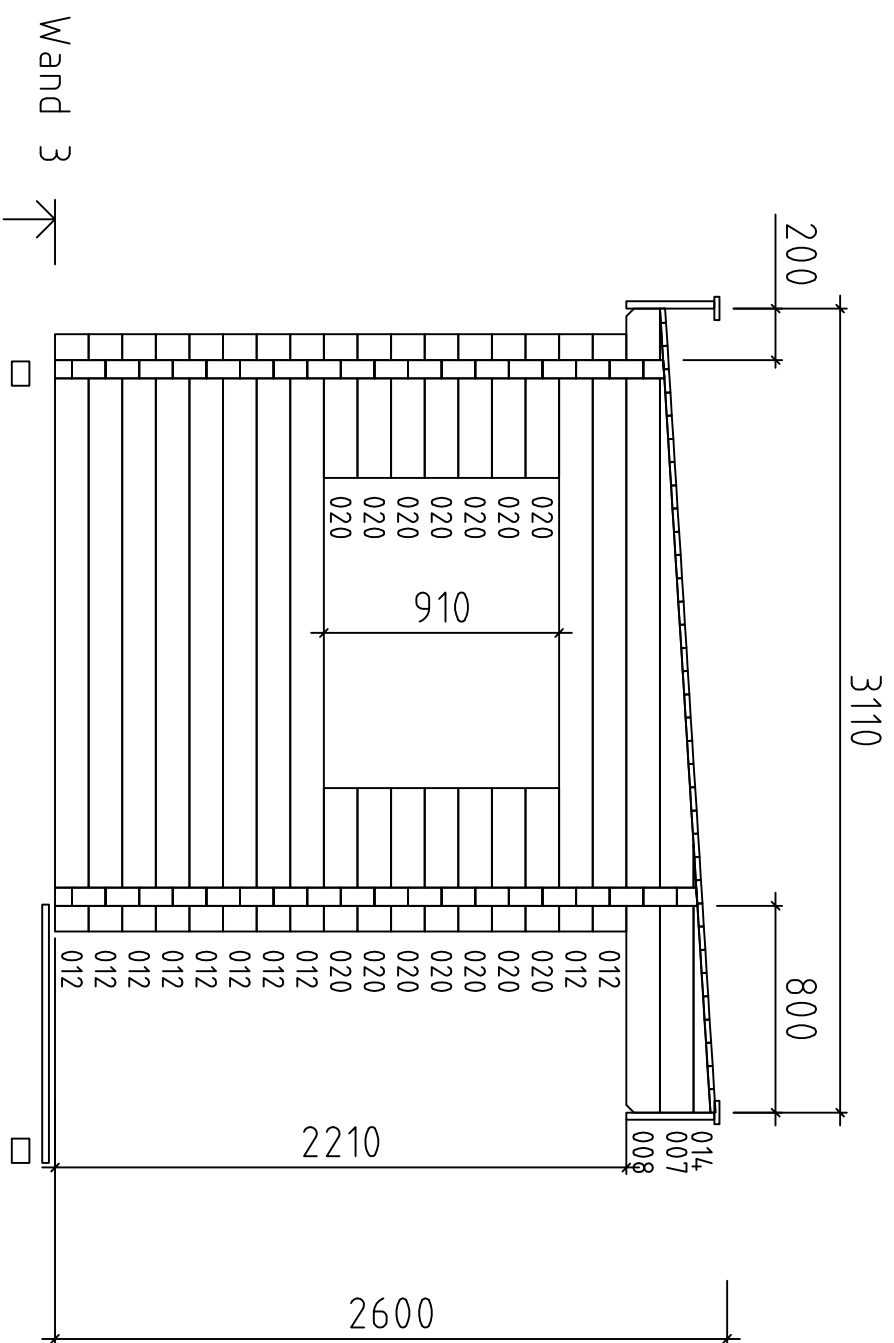

Aussensauna 3432 M / 70 / 2014

Wand 4 ↗

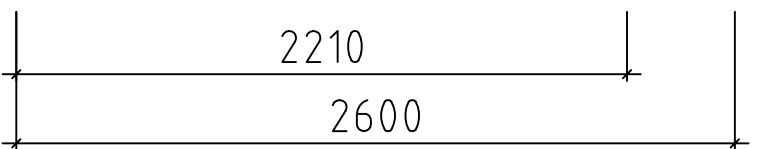
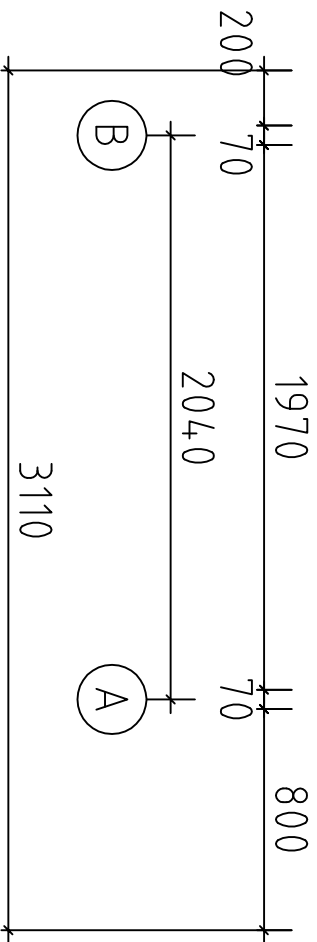

Aussensauna 3432 M / 70 / 2014

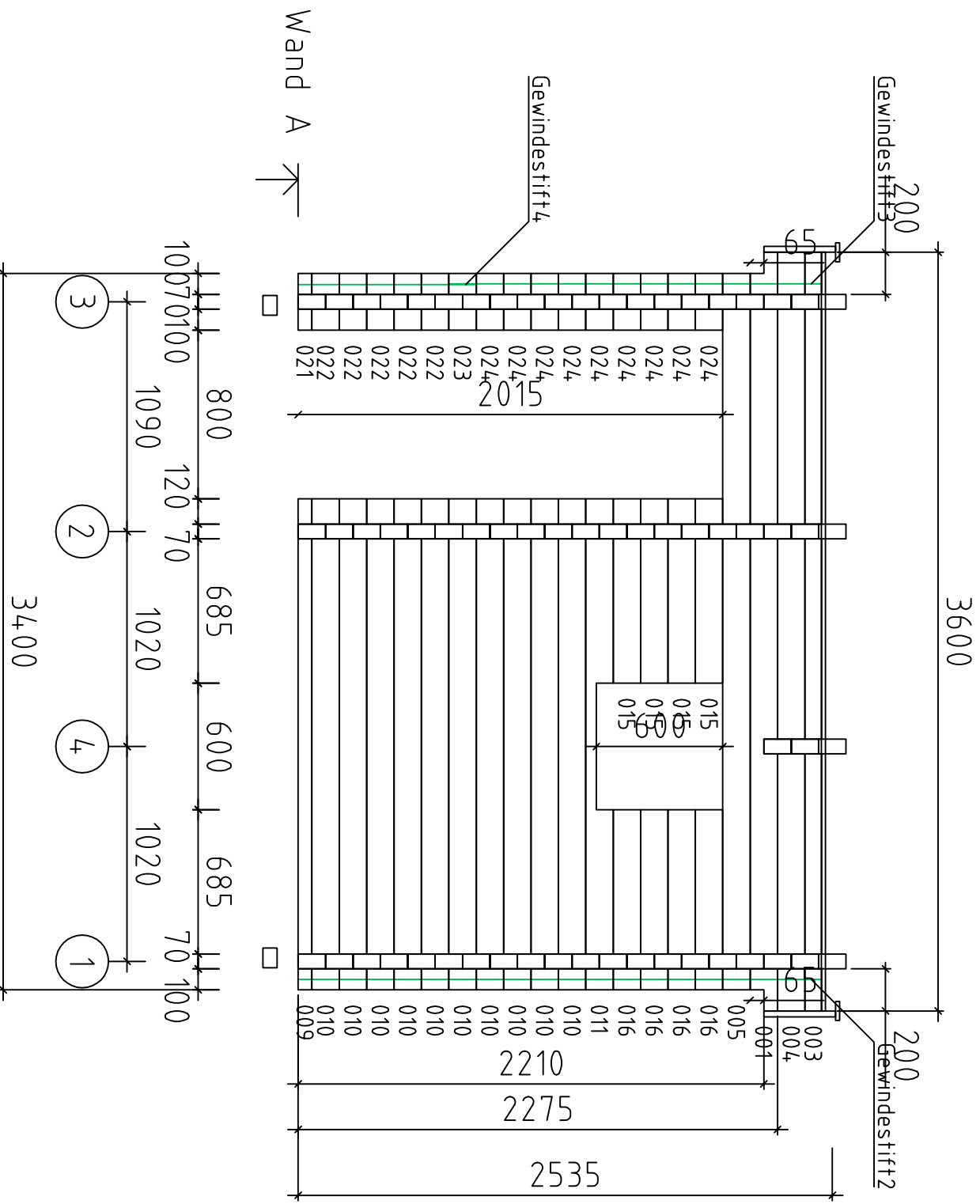

Aussensauna 3432 M / 70 / 2014

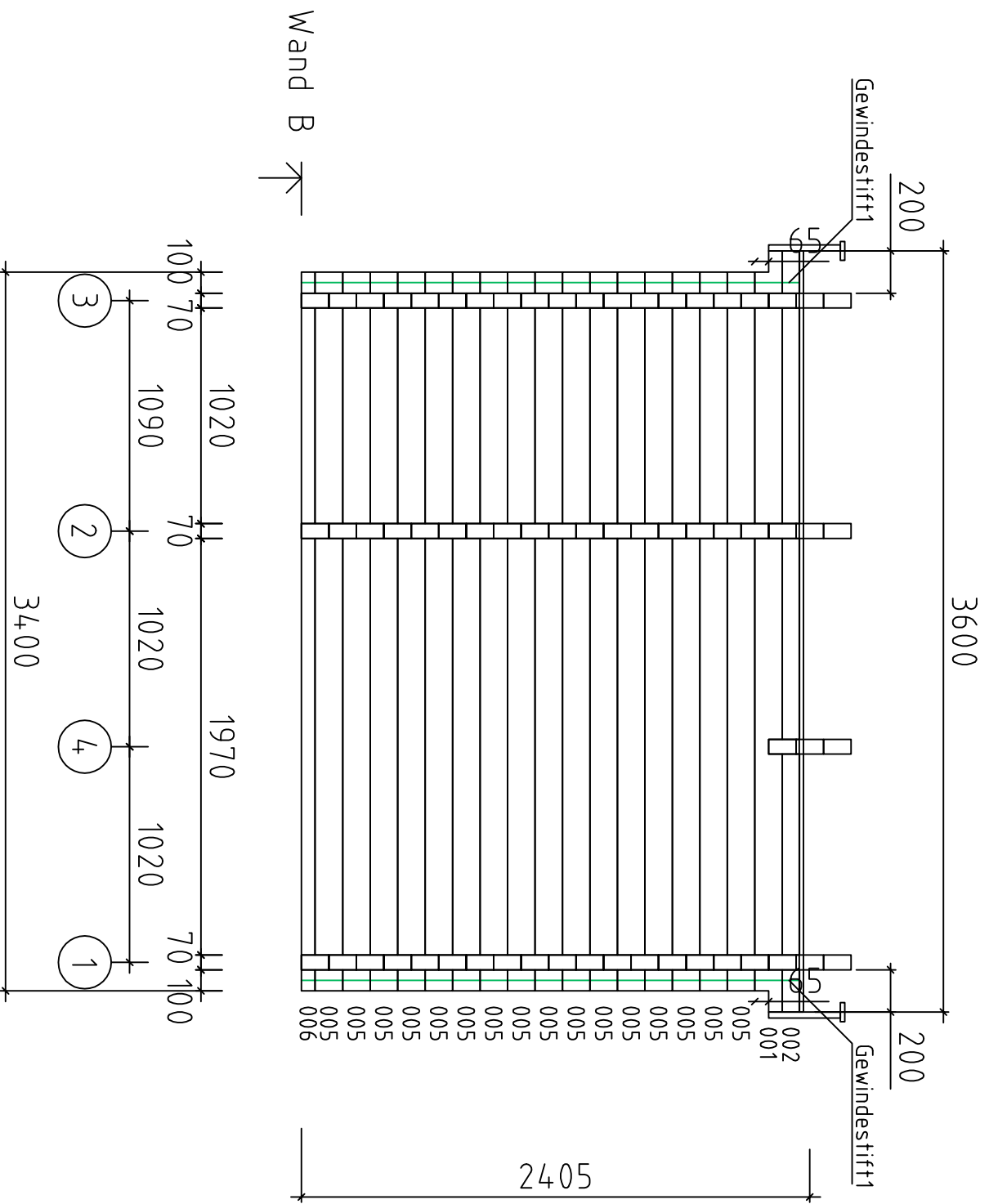

Aussensauna 3432 M / 70 / 2014

Aussensauna 3432 M / 70 / 2014

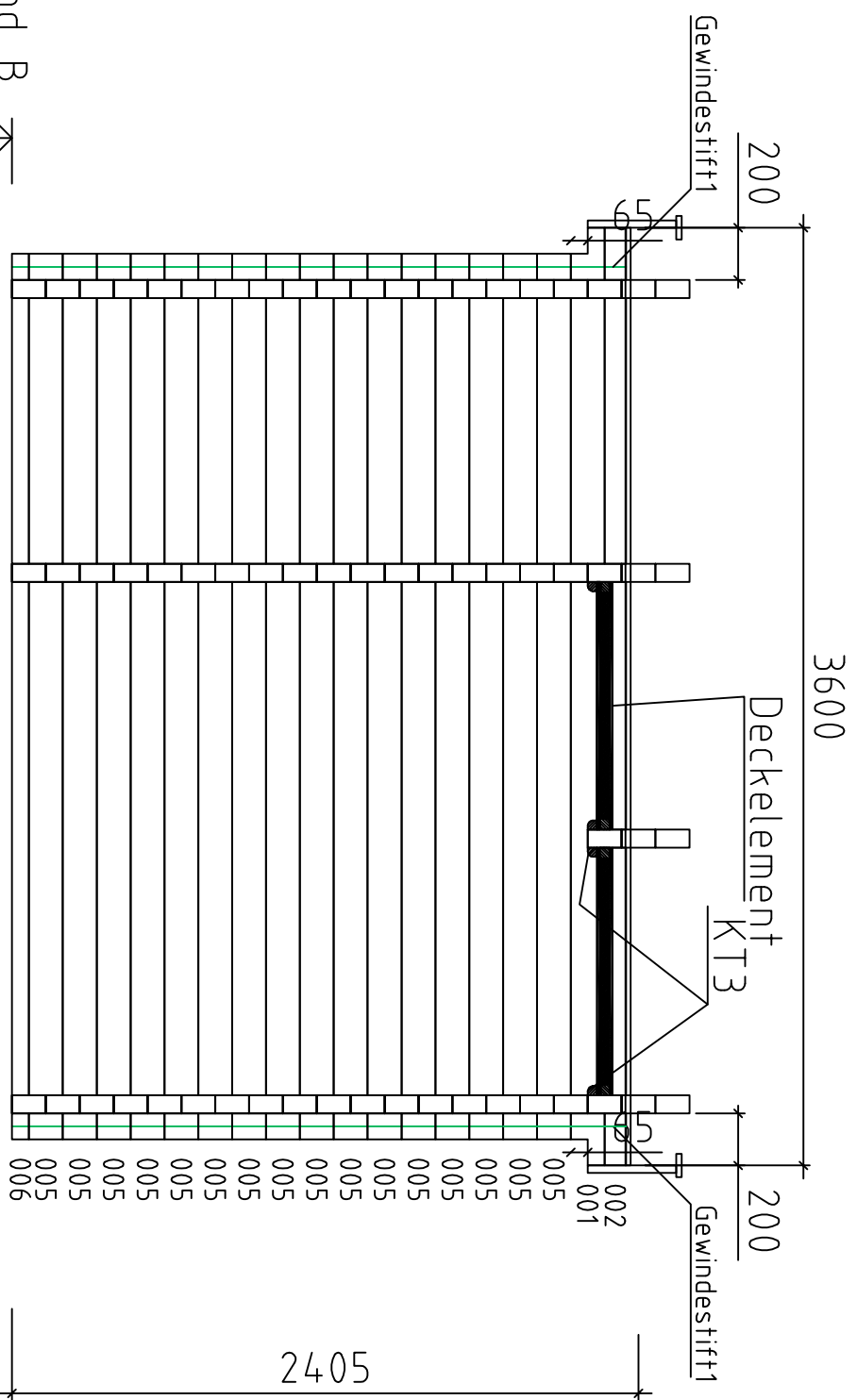

Wand B ↗

Deckelemente

Schrauben 3,5x50

033

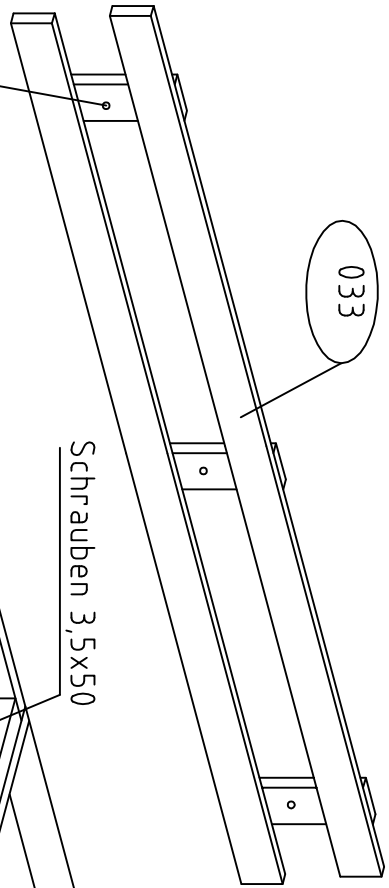

Schrauben 3,5x50

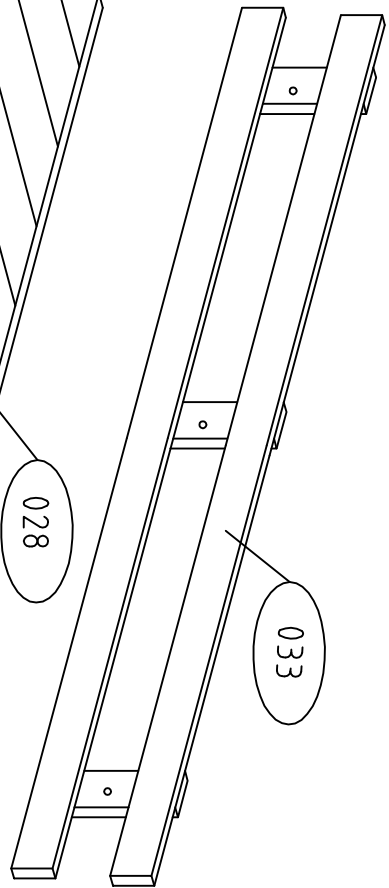

033

028

029

Schrauben 3,5x50

040

041

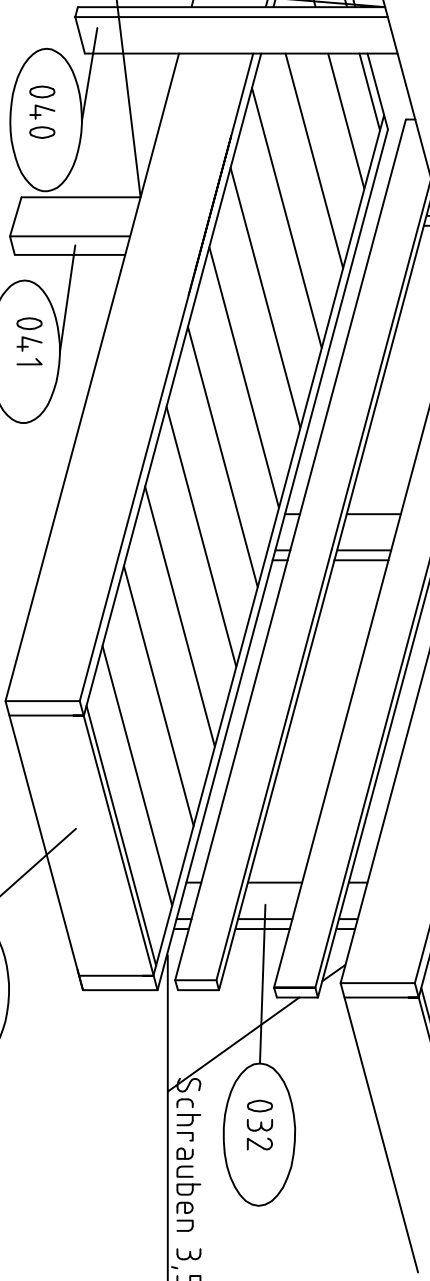









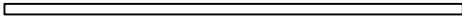
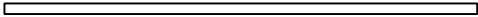
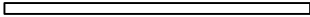
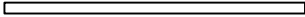
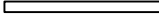
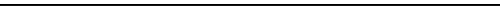

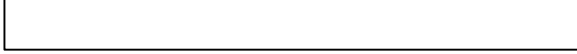
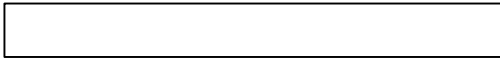



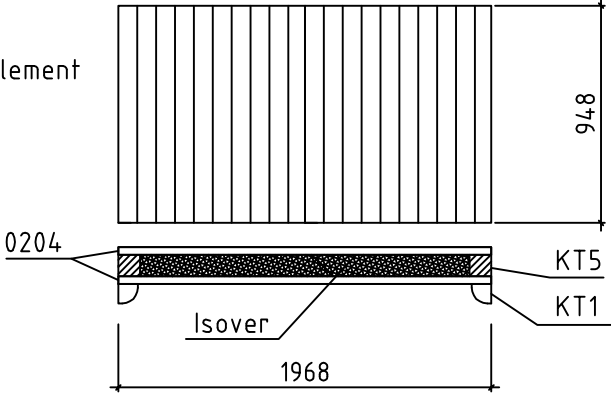

032



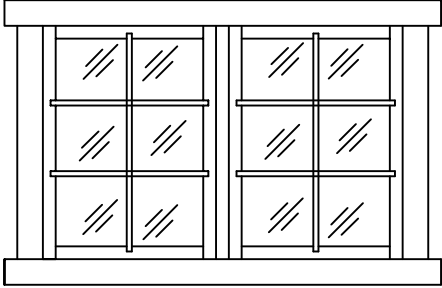
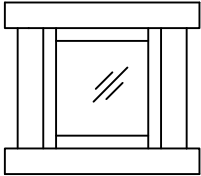

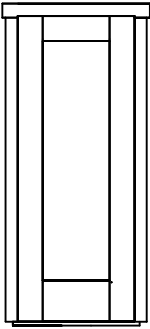
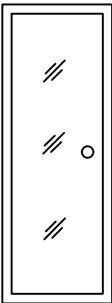
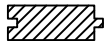

Schrauben 3,5x50

028

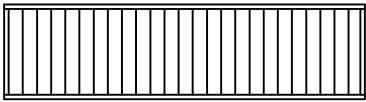
Pos	Aussensauna 3432 M / 70 / 2014	ST	F (mm)	L (mm)
001		2	70x130	3600
002		1	70x82	3600
003		1	70x80	3600
004		1	70x130	3600
005		17	70x130	3400
006		1	70x65	3400
007		4	70x130	3110
008		4	70x130	3110
009		1	70x65	2330
010		10	70x130	2330
011		1	70x130	2330
012		29	70x130	2310
013		1	70x130	2310
014		4	70x65	1037
015		4	70x130	875
016		4	70x130	855
017		14	70x130	845
018		13	70x130	765
019		1	70x130	765
020		14	70x130	555
021		1	70x65	270
022		5	70x130	270
023		1	70x130	270
024		9	70x130	270

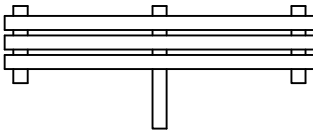
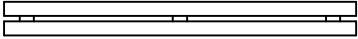
Pos	Aussensauna 3432 M / 70 / 2014		ST	F (mm)	L (mm)
AR5	Fundamentbalken 		2	94x68	2912
AR4	Fundamentbalken 		3	68x68	3002
AR3	Fundamentbalken 		2	68x68	1942
AR6	Fundamentbalken 		1	68x68	1908
AR2	Fundamentbalken 		2	68x68	992
AR1	Fundamentbalken 		2	94x68	3190
HL1	Karniese Deckbretter 		2	90x20	3690
HL2	Karniese Deckbretter 		2	90x20	3020
vÖ1	Karniese 		2	28x340	3656
vÖ2	Karniese 		2	28x340	3166
KT3	Deckelementträger  		4	35x35	1970
KT1	Deckelementträger  		4	35x35	950
054	Deckelement 		2		
	Materjal für Deckelemente				
0204	Deckelementbretter 		88	90x12	948
KT4	Deckelement Distanzleiste 		4	50x50	1968
KT5	Deckelement Distanzleiste 		4	50x50	848

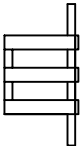
Pos	Aussensauna 3432 M / 70 / 2014			ST	F (mm)	L (mm)				
A2S91	Fenster 1200x910  <table border="1" data-bbox="657 197 1174 313"> <tr> <td>Iso</td> <td>672x442=2st.</td> </tr> <tr> <td>Blech</td> <td>45x495= 2st.</td> </tr> </table>			Iso	672x442=2st.	Blech	45x495= 2st.	1		
Iso	672x442=2st.									
Blech	45x495= 2st.									
SBS 6x6	Fenster 600x600 väljapoole avanev tihendiga  <table border="1" data-bbox="529 618 1046 734"> <tr> <td>Iso</td> <td>437x427</td> </tr> <tr> <td></td> <td></td> </tr> </table>			Iso	437x427			1		
Iso	437x427									
T1	Tür 800x2015   <table border="1" data-bbox="746 851 906 913"> <tr> <td>Iso</td> </tr> </table> <p> Tenderleiste 23x23x1985=2tk Sauna uks AB / 70 avale 800x2015 ISO 1541x447 Kotike </p>			Iso	1L					
Iso										
T2	Tür 700x1900 Alumise pakuga  <p> Klaasuks pronksivärvi Tenderleiste 23x23x1855=2tk </p>			1L						
0203	Fussbodenbretter			34	90x26	1966				
	Terrassenbretter			34	90x26	1000				
	Dachbretter			36	90x20	3600				
	Abdeckleiste				20x40	30				
Kood		Materjal		File trükk.dwg		Leht 3/3				

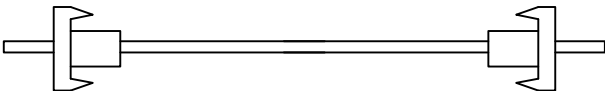
Pos	Aussensauna 3432 S / 50 / 2013		ST	F (mm)	L (mm)
028	Liegen		2		1968
029	Aspen		1		1412
037	Träger für Liegen		2	44x68	1100
038			1	44x68	700
039			2	44x68	576
040	Liegenstütze		1	44x68	841
041			1	44x68	360
032	Zwischenbankverkleidung Aspen		1		
033	Rückenlehnen Aspen		1+1		
034	Ofenschutzgitters	 	1		
035	Kopfstütze Aspen		2		
046	Schrauben für Liegenträger		50	4,5x70	
047	Schrauben für Liegen		50	3,5x50	
048	Schrauben für Ofenschutzgitters		20	4x80	
	Schrauben für Deckelementträger		20	4x80	
	Dichtungsband			4x80	10m
			4		2350