



Sully / Talinn

Art.nr. 1007821 / 2812150

1/6



19.01.2017





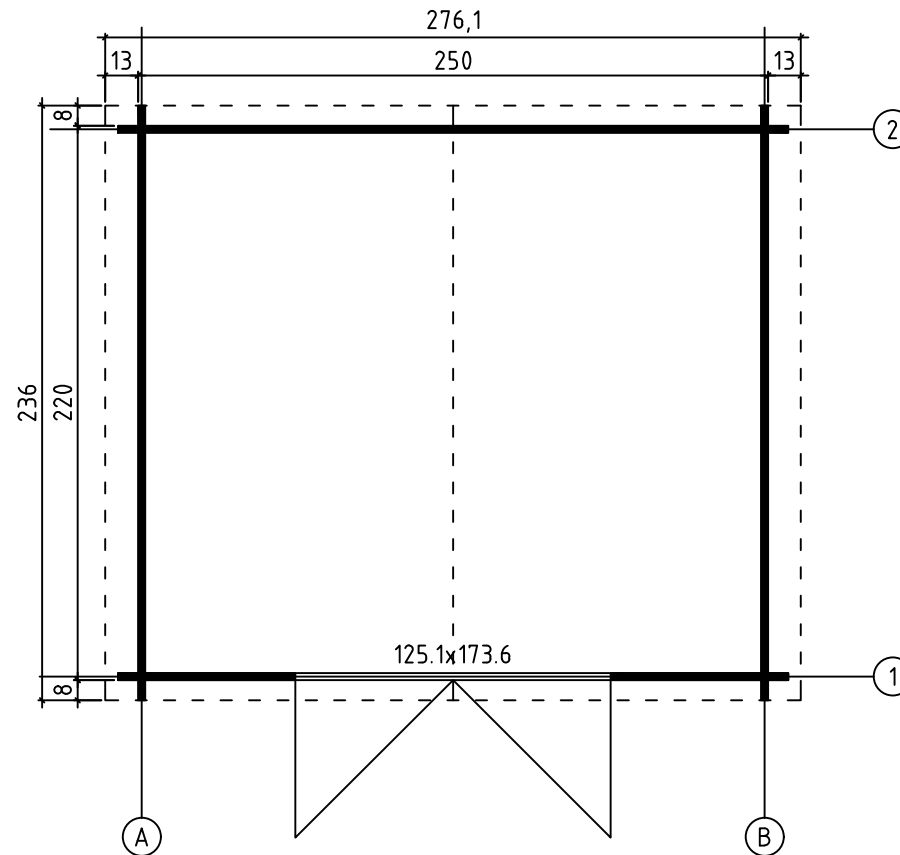

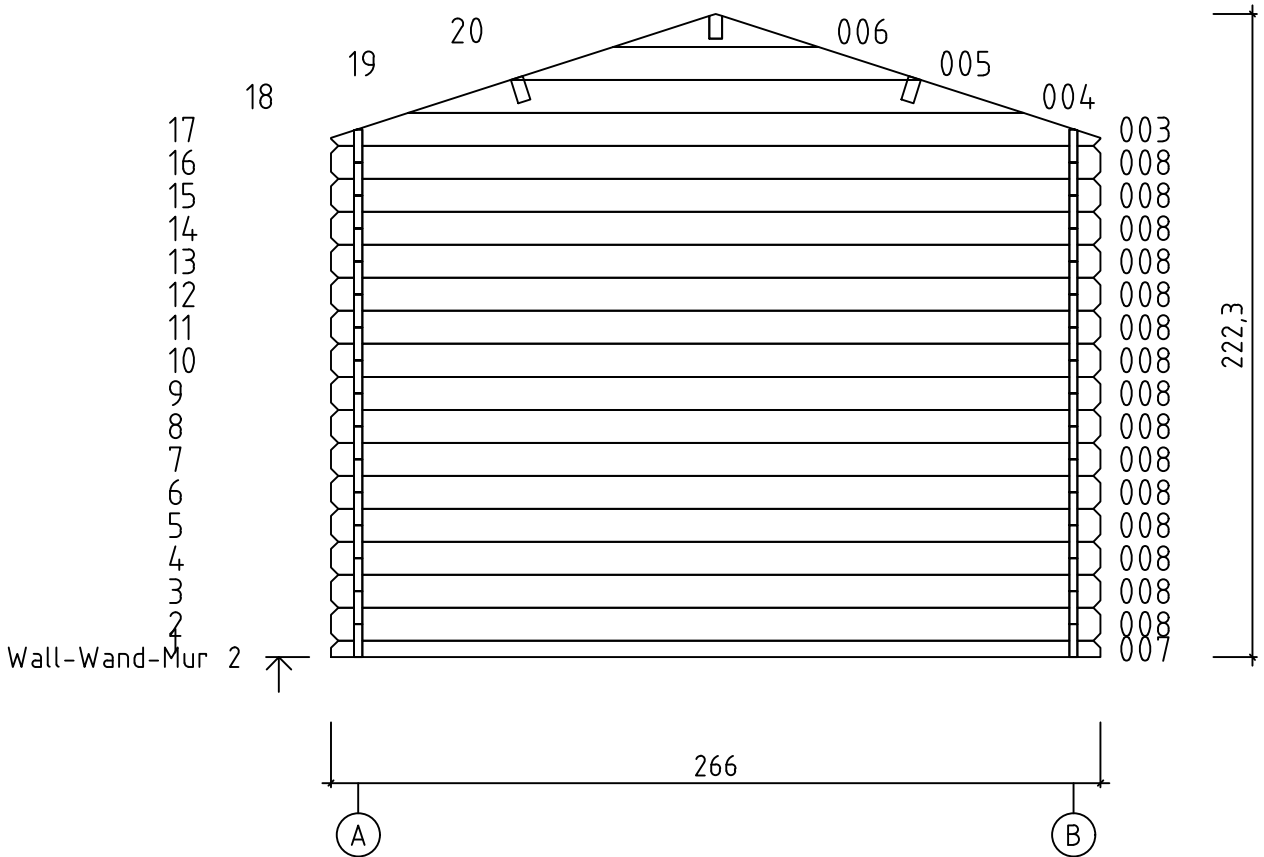
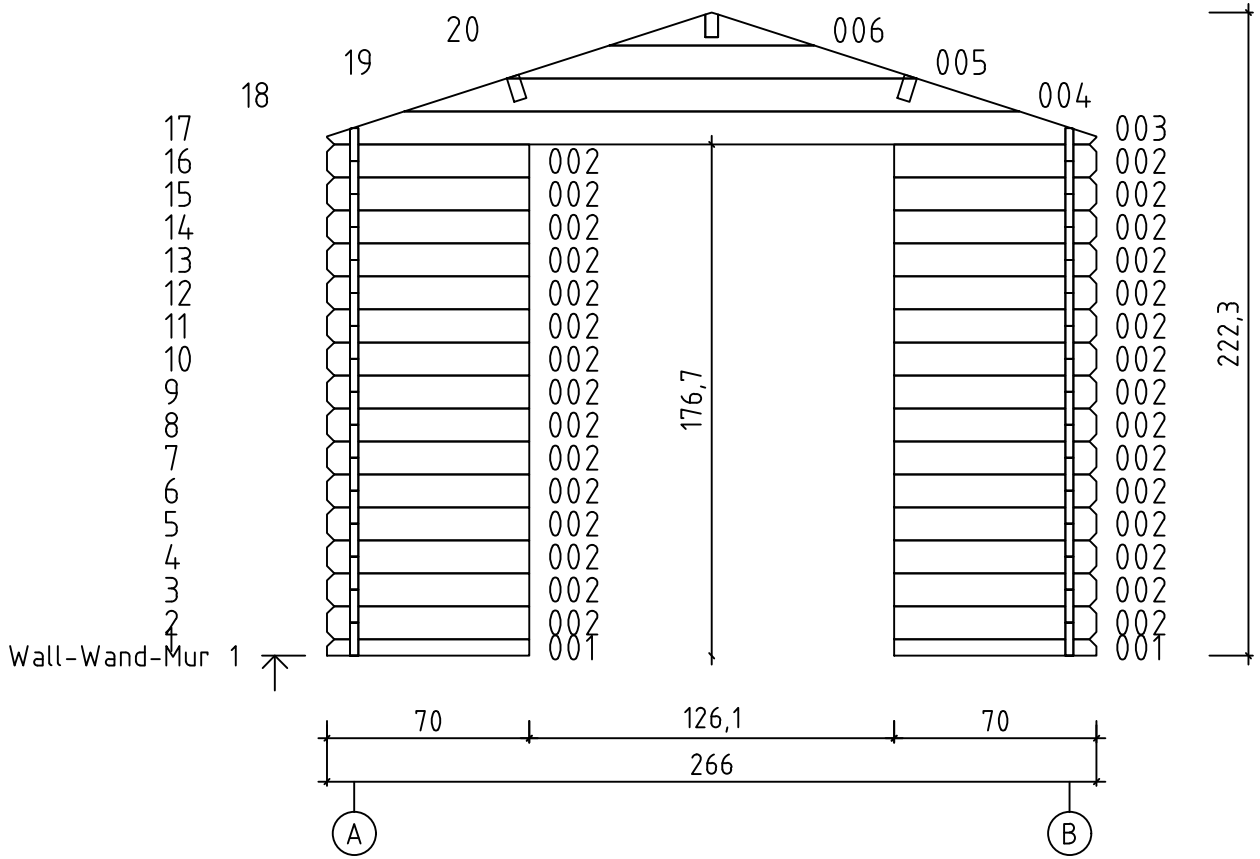

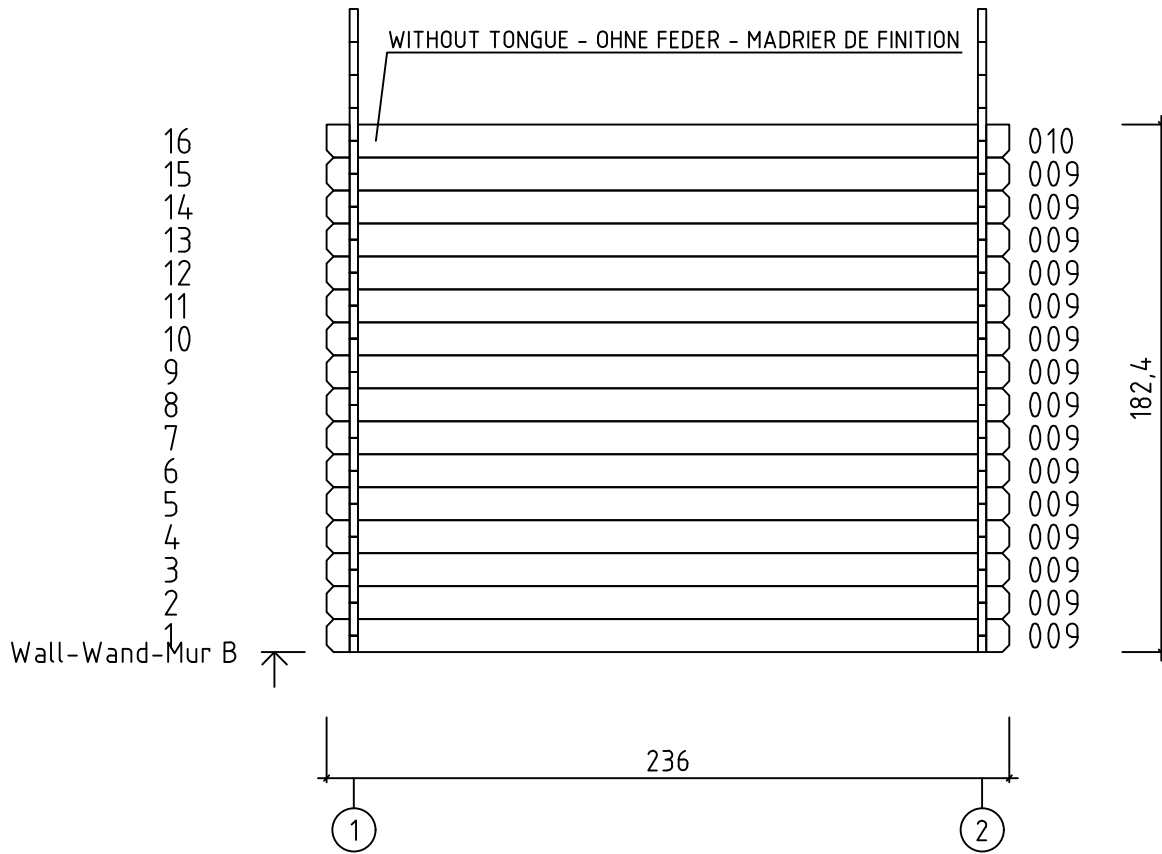
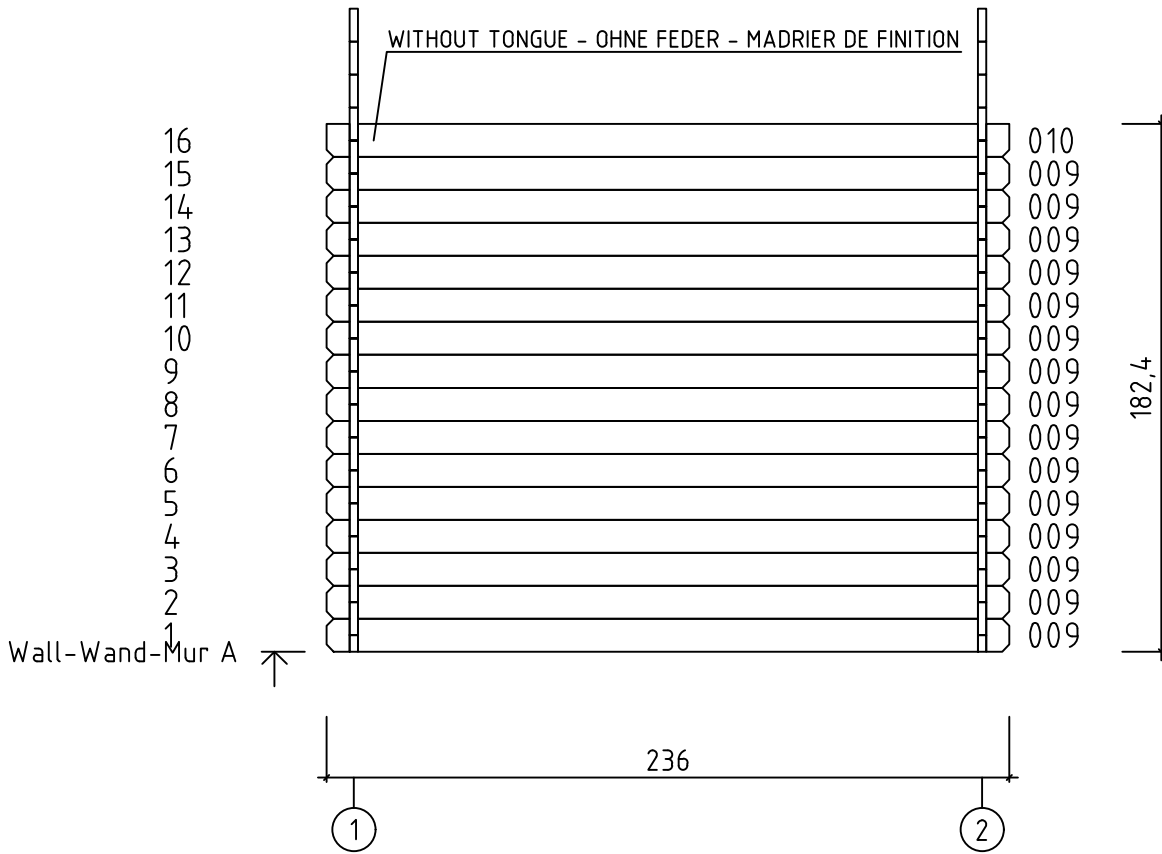

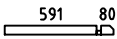
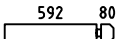
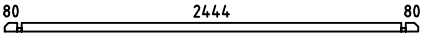
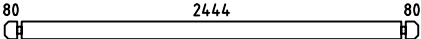
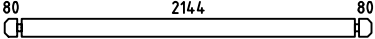
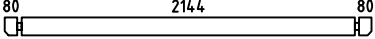
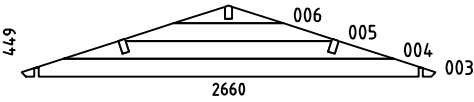
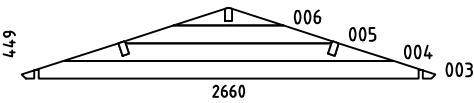
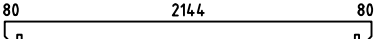
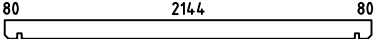
Art.Nr. 2812150

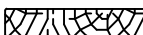
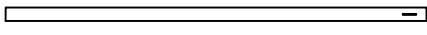

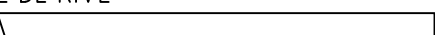

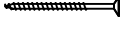

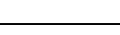

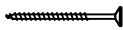
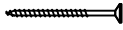

GRUNDPLAN - GRUNDPLAN - PLAN DE MASSE

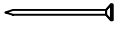
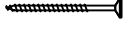



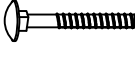

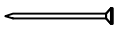
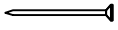
Pos	19.01.2017	Piecelist - Stücklist - Liste des composants Art.Nr. 2812150	5/6	Q.	P. (mm)	L. (mm)
001				2	28x57	700
002				30	28x114	700
007				1	28x57	2660
008				15	28x114	2660
009				30	28x114	2360
010				2	28x114	2360
W1-1				1		
W2-1				1		
PR1	 ROOF BEAM - DACHBALKEN - PANNE DE TOIT			1	44x120	2360
A-PR1	 ROOF BEAM - DACHBALKEN - PANNE DE TOIT			2	44x120	2360
	ROOF BOARDS - DACHBRETTER - VOLIGES			54	90x15	1450
DPL	ROOFING FELT FILLET - DACHPAPPENLEISTE - BAGUETTE DE FIXATION DU FEUTRE BITUMEUX			4	18x58	1500
TB	EAVES BOARD - TRAUFBRETT - BANDEAU DE TOIT			2	18x58	2360
KFS	STORM PROTECTION - STURMLEISTE - LATTE ANTI-TEMPETE			4	22x45	2050
DPC	ROOFING FELT - DACHPAPPE - FEUTRE BITUMEUX			4		2460
GL1	GABLE MOULDING - GIBELLEISTE - PLANCHE DE RIVE			4	18x90	1500
	SCREW FOR GABLE SEGMENT - SCHRAUBEN FÜR DECKBLATT - VIS POUR FIXATION LOSANGE DE FINITION			4	3.5x35	
HS22	SCREW FOR FIXING DOOR TO THE WALL - SCHRAUBE ZUR BEFESTIGUNG TÜR- ZARGE MIT WAND - VIS DE FIXATION DORMANT DE PORTE			2	3.5x50	
HS3	SCREW FOR DOOR FILLET - SCHRAUBE ZUR BEFESTIGUNG TÜRLEISTE - VIS D'ASSEMBLAGE DU CADRE DE PORTE			5	3x30	
HS59	SCREW FOR DOORSTEP - SCHRAUBEN FÜR SWELLE - VIS DE FIXATION DU SEUIL DE PORTE			3	3x30	
HS56	SCREW FOR FIXING BOLT HINGE - SCHRAUBE FÜR TÜRRIGEL - VIS DE FIXATION POUR CHARNIERES ET GONDS DE PORTE			16	4x30	
HS58	SCREW FOR FIXING BOLT HINGE - SCHRAUBE FÜR TÜRRIGEL - VIS DE FIXATION POUR CHARNIERES ET GONDS DE PORTE			12	4x40	
HS77	SCREW FOR DOOR JAMB - SCHRAUBE FÜR TÜRRAHMEN - VIS DE FIXATION POUR MONTANT DE PORTE			2	4x60	

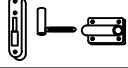
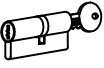
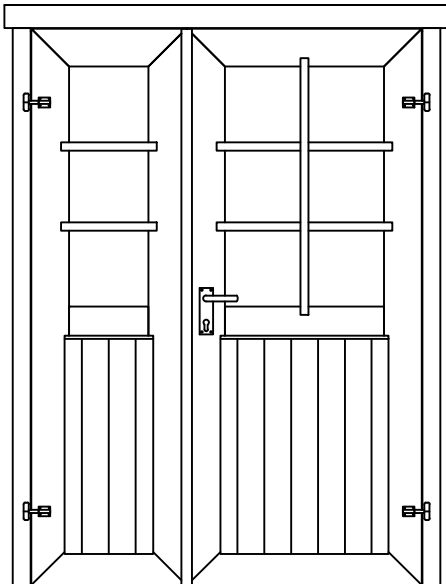
Pos	19.01.2017	Piecelist - Stücklist - Liste des composants Art.Nr. 2812150	6/6	Q.	P. (mm)	L. (mm)
HS43		SCREW FOR ROOF BEAMS - SCHRAUBEN FÜR DACHBALKEN - VIS POUR PANNE DE TOIT		10	5x120	
HS41		SCREW FOR DOOR JAMB - SCHRAUBE FÜR TÜRRAHMEN - VIS DE FIXATION POUR MONTANT DE PORTE		2	5x90	
		HAMMER BLOCK - SCHLAGHOLZ - CALLE DE FRAPPE		1		
NF		ROOFING NAILS FOR ROOFING FELT - NÄGEL FÜR DACHPAPPE - POINTE DE FIXATION POUR FEUTRE BITUMEUX		102	2.8x15	
		SCREW FOR GABLE MOULDING - SCHRAUBEN FÜR GIEBELLEISTE VIS DE FIXATION POUR PLANCHE DE RIVE		24	3.5x50	
		SCREW FOR EAVES BOARDS - SCHRAUBEN FÜR TRAUFBRETTEN VIS DE FIXATION POUR BANDEAU DE TOIT		12	4x40	
TL		LATCH BOLT FÜR DOUBLE DOOR - TORRIEGEL - LOQUET POUR DOUBLE PORTE		2		
GS		GABLE SEGMENT-DECKBLATT - LOSANGE DE FINITION		2		
		NUT FOR STORM PROTECTION - SCHRAUBENMUTTER FÜR STURMLEISTE - ÉCROU POUR LAME ANTI-TEMPETE		8	D6	
BFS		BOLT FOR STORM PROTECTION - BOLZEN FÜR STURMLEISTE - VIS POUR LAME ANTI-TEMPETE		8	6x60	
DFS		WASHER FOR STORM PROTECTION - DICHTSCHEIBE FÜR STURMLEISTE - RONDELLE POUR LAME ANTI-TEMPETE		8	D6	
		ZN NAIL FOR ROOFING FELT FILLET - ZN NÄGEL FÜR DACHPAPPEN LEISTE - POINTE POUR BAGUETTE FIXATION FEUTRE BITUMEUX		16	2x40	
		ZN NAIL FOR ROOF - ZN NÄGEL FÜR DACHBRETTEN - POINTE POUR TOIT		176	2x50	
TS3		DOOR HANDLE FITTINGS-TÜRGRIFF - SET DE GARNITURES DE SERRURE DE PORTE		1		
TS4		SET OF DOOR LOCK COVERS - SCHLOSSBLENDEN - SET DE GARNITURES DE SERRURE DE PORTE		1		
TT		MALE BOLT HINGE FOR DOOR - TÜRRIEGEL - PARTIE MALE DE CHARNIERE DE PORTE		4		
TS6		CYLINDER LOCK - ZYLINDERSCHLOSS - CYLINDRE DE SERRURE		1	30x30	
		DOOR-TÜR-PORTE 1251x1736		1		
		TUK.2.056.SVP.MX28d SGA+28				
						

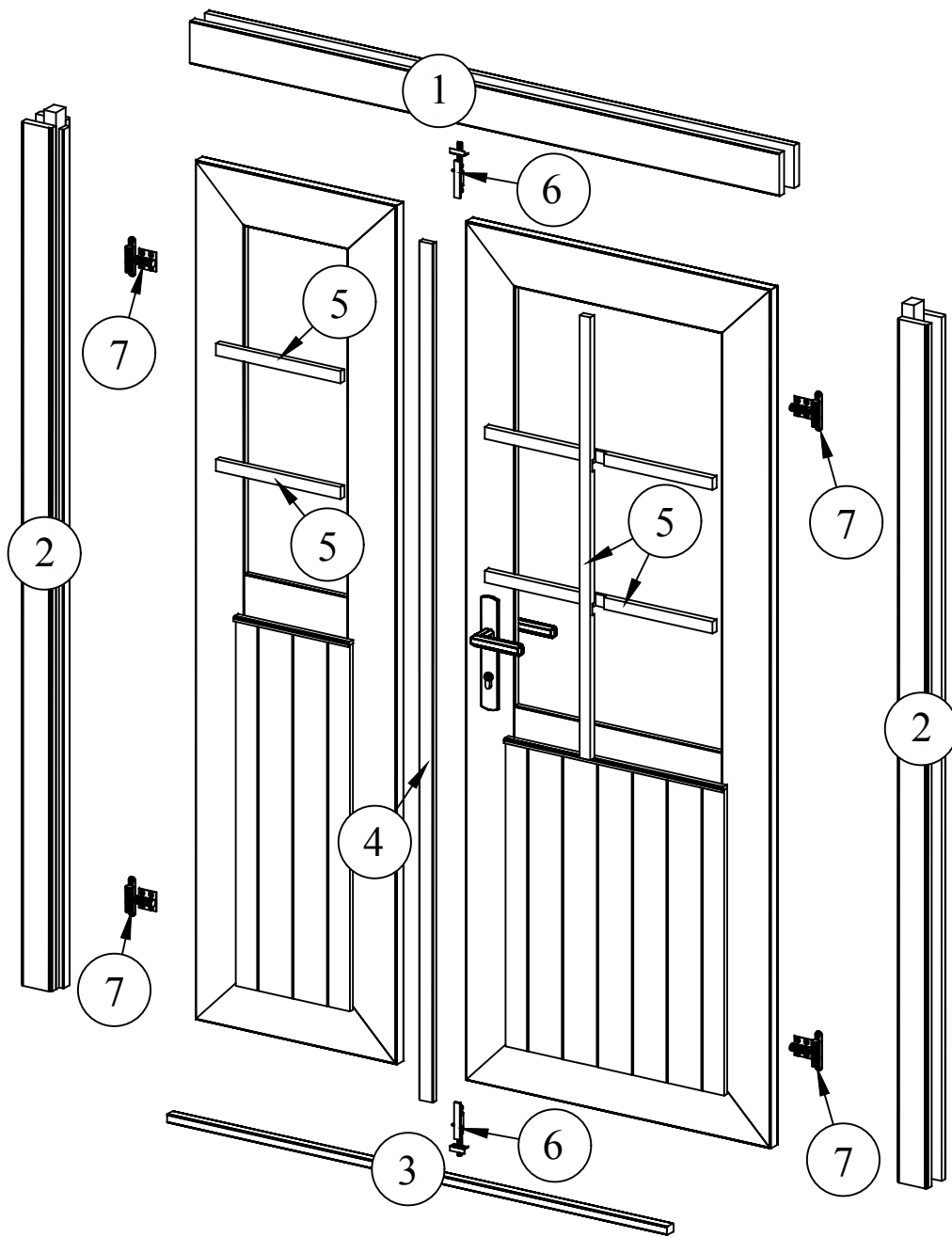

Pos	Piece list - Stückliste - Liste des pièces	Q.	P (mm)
1		1	66x100
2		2	66x80
3		1	18x18
4		1	13x32
5		5	15x25
6		2	
7		4	

