

Always keep the package number saved! Without package number there is no guarantee.
 Package number:

WALL LOG (mm): 45

BUILDING CODE

Agnes

SIZE (mm): 4400x3000

COMPONENT SPECIFICATION

NUMBER	COMPONENT FUNCTION	COMPONENT CODE	VIEW	SIDE VIEW	DIMENSIONS (mm)			QUANTITY (psc.)
					LENGHT	WIDTH	THICKNESS	
1	Wall board	A1			3434	115	45	1
2	Wall board	A2			2014	115	45	5
3	Wall board	A3			617	115	45	10
4	Wall board	A4			617	115	45	10
5	Wall board	A5			2980	115	45	1
6	Wall board	A6			200	115	45	16
7	Wall board	B1,A7			4400	115	45	19
8	Wall board	B2,A8			4400	115	45	2
9	Wall board	D2,E2,C5			3000	115	45	38
10	Wall board	C6,E3			3000	115	45	2
11	Wall board	C2			2034	115	45	6
12	Wall board	C3			627	115	45	10
13	Wall board	C4			627	115	45	10
14	Wall board							
15	Wall board							
16	Wall board							
17	Wall board							
18	Wall board							
19	Wall board							
20	Wall board							
21	Wall board							
22	Wall board							
23	Wall board				2034	60	45	1
24	Wall board	C1			3000	60	45	2
25	Wall board	D1,E1						
26	Wall board	D3						
27	Window				770	1120	2	
28	Door				1200	1880	1	
29	Door				1200	1880	1	
30	Roof cover fixture				3300	100/120	16	2
31	Roof cover fixture				2350	100/120	16	4
32	Roof board				1430	110	19	8
33	Beam				2283	60	40	4
34	Beam				1693	60	40	4
35	Beam				1734	60	40	2
36	Beam				1682	60	40	2
37	Beam				990	60	40	8
38	Beam				1400	120	40	1
39	Trigonal							1

PACKAGE NR.:

MNFCT. ORDER NR.:

CONTROL 1

CONTROL 2

PAGE/PAGES:

1/7

SIGNATURE

SIGNATURE

BUILDING CODE **Agnes**

WALL LOG (mm): 45

SIZE (mm): 4400x3000

ISOMETRIC VIEW

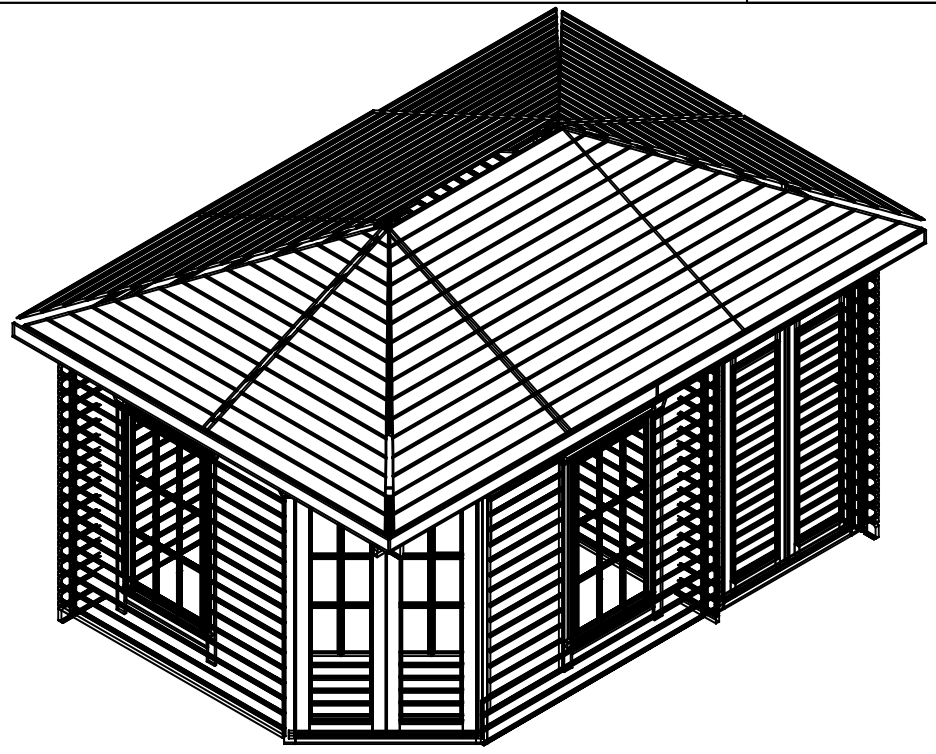

TOP VIEW

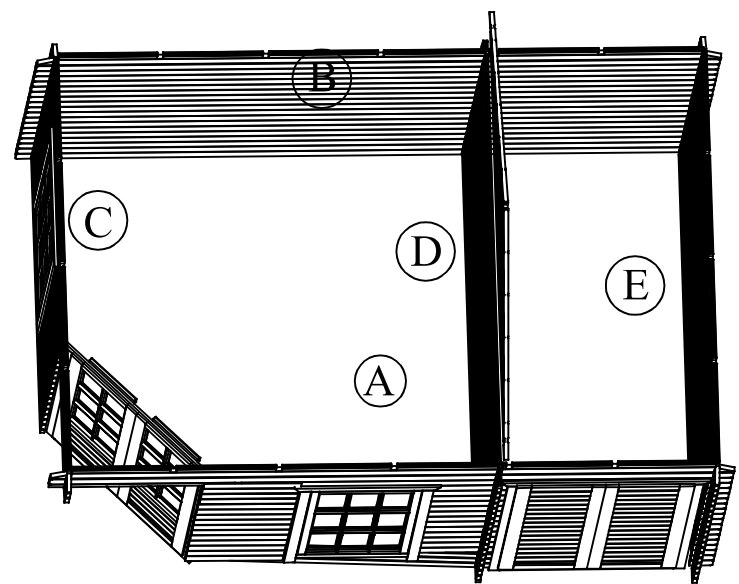

PACKAGE NR.:

MNFCT. ORDER NR.:

CONTROL 1
SIGNATURE

CONTROL 2
SIGNATURE

PAGE/PAGES: **2/7**

BUILDING CODE **Agnes**

WALL LOG (mm): 45

SIZE (mm): 4400x3000

FRONT VIEW

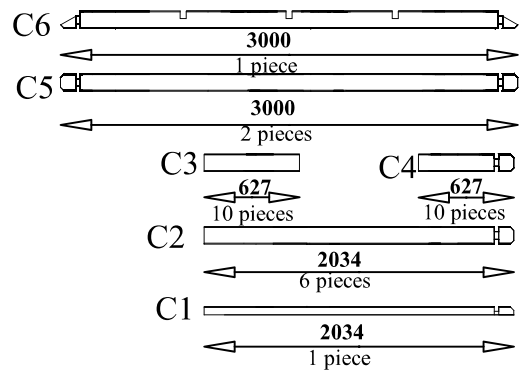
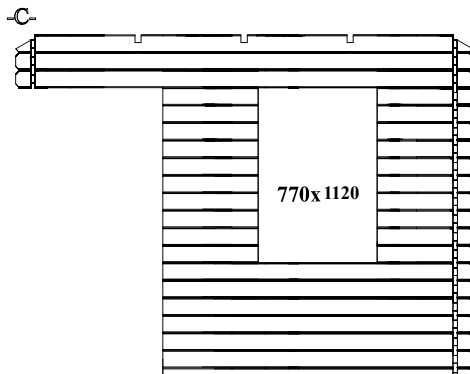

INSIDE VIEW

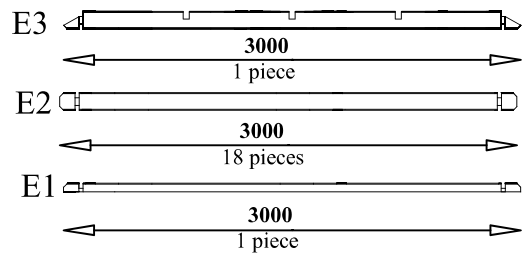
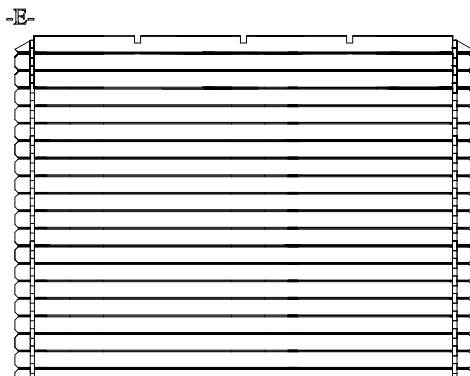

BACK VIEW

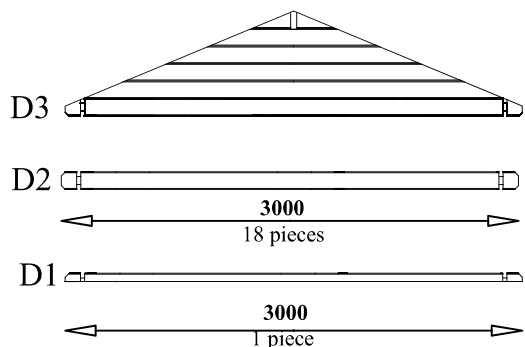
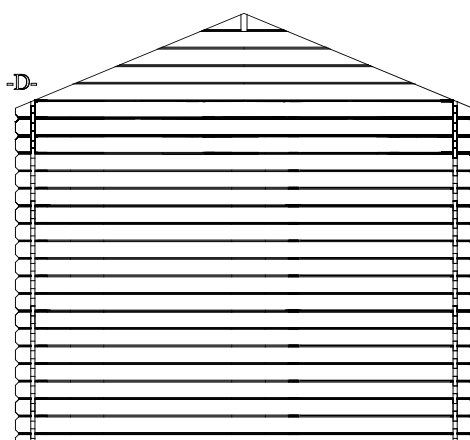

PACKAGE NR.:

MNFCT. ORDER NR.:

CONTROL 1
SIGNATURE

CONTROL 2
SIGNATURE

PAGE/PAGES: **3/7**

BUILDING CODE **Agnes**

WALL LOG (mm): 45

SIZE (mm): 4400x3000

LEFT VIEW

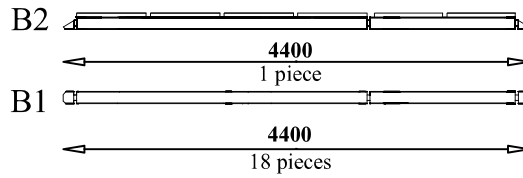
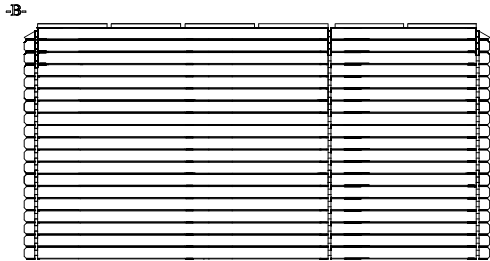

RIGHT VIEW

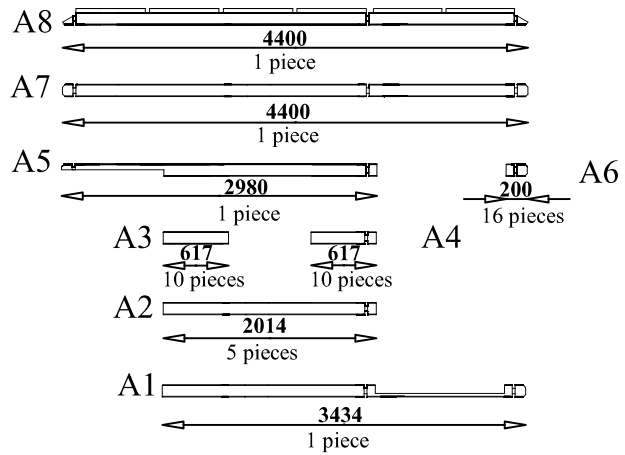
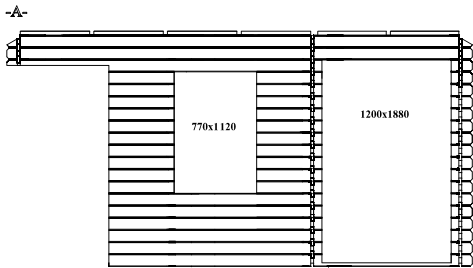

PACKAGE NR.:

MNFCT. ORDER NR.:

CONTROL 1
SIGNATURE

CONTROL 2
SIGNATURE

PAGE/PAGES: **4/7**

BUILDING CODE **Agnes**

WALL LOG (mm): 45

SIZE (mm): 4400x3000

CONSTRUCCION 1

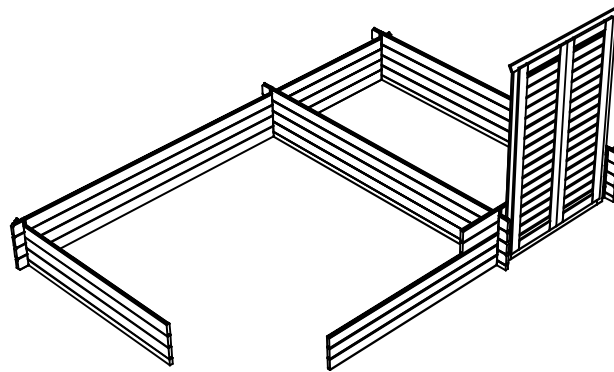

CONSTRUCCION 2

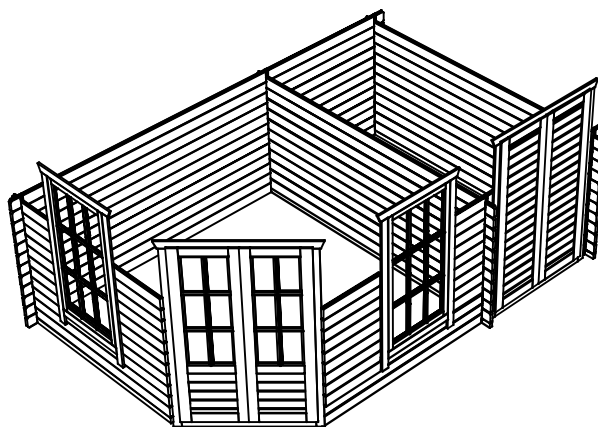

PACKAGE NR.:

MNFCT. ORDER NR.:

CONTROL 1

SIGNATURE

CONTROL 2

SIGNATURE

PAGE/PAGES: **5/7**

BUILDING CODE

Agnes

WALL LOG (mm): 45

SIZE (mm): 4400x3000

CONSTRUCCION 3

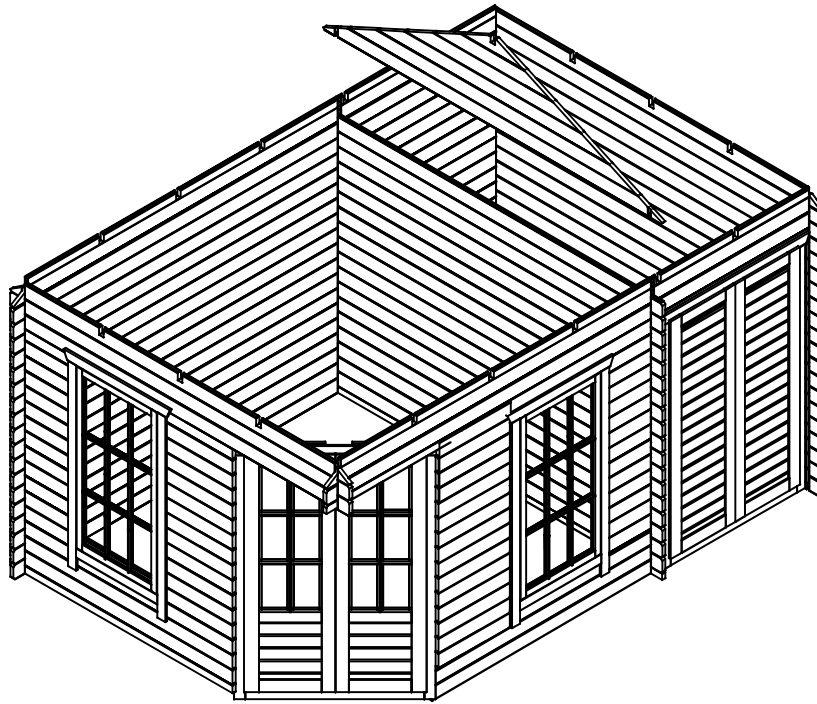

CONSTRUCCION 4

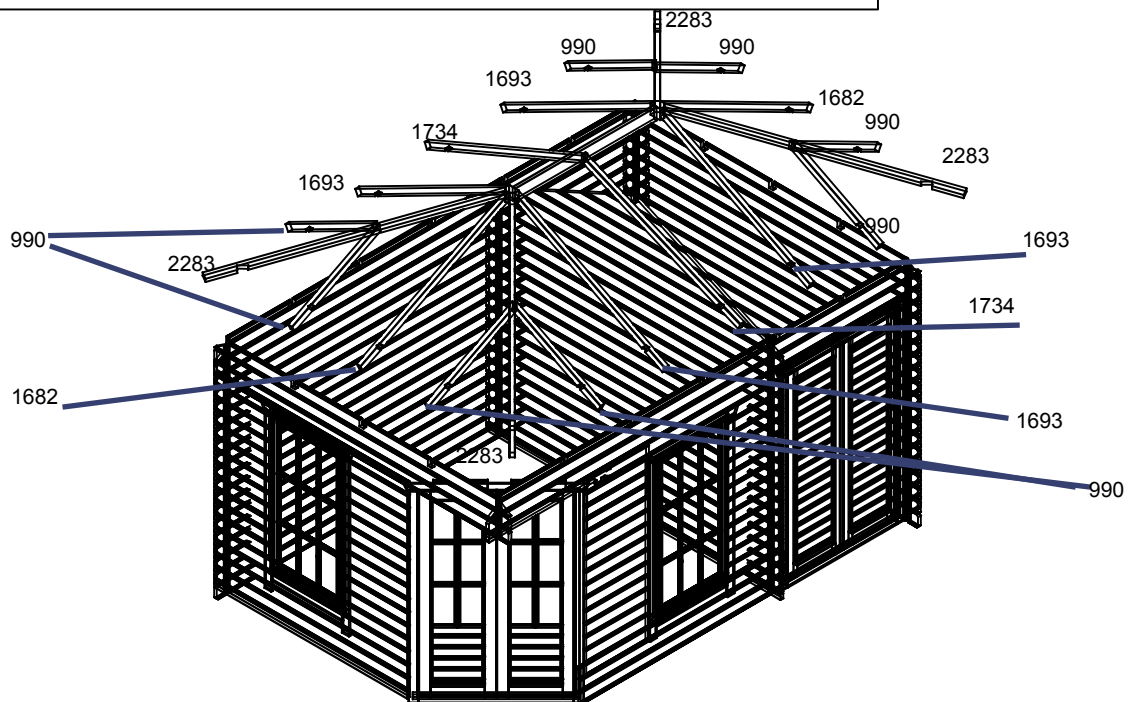

PACKAGE NR.:

MNFCT. ORDER NR.:

CONTROL 1

CONTROL 2

SIGNATURE

SIGNATURE

PAGE/PAGES: **6/7**

BUILDING CODE **Agnes**

WALL LOG (mm): 45

SIZE (mm): 4400x3000

ISOMETRIC ROOF'S CONSTRUCTION

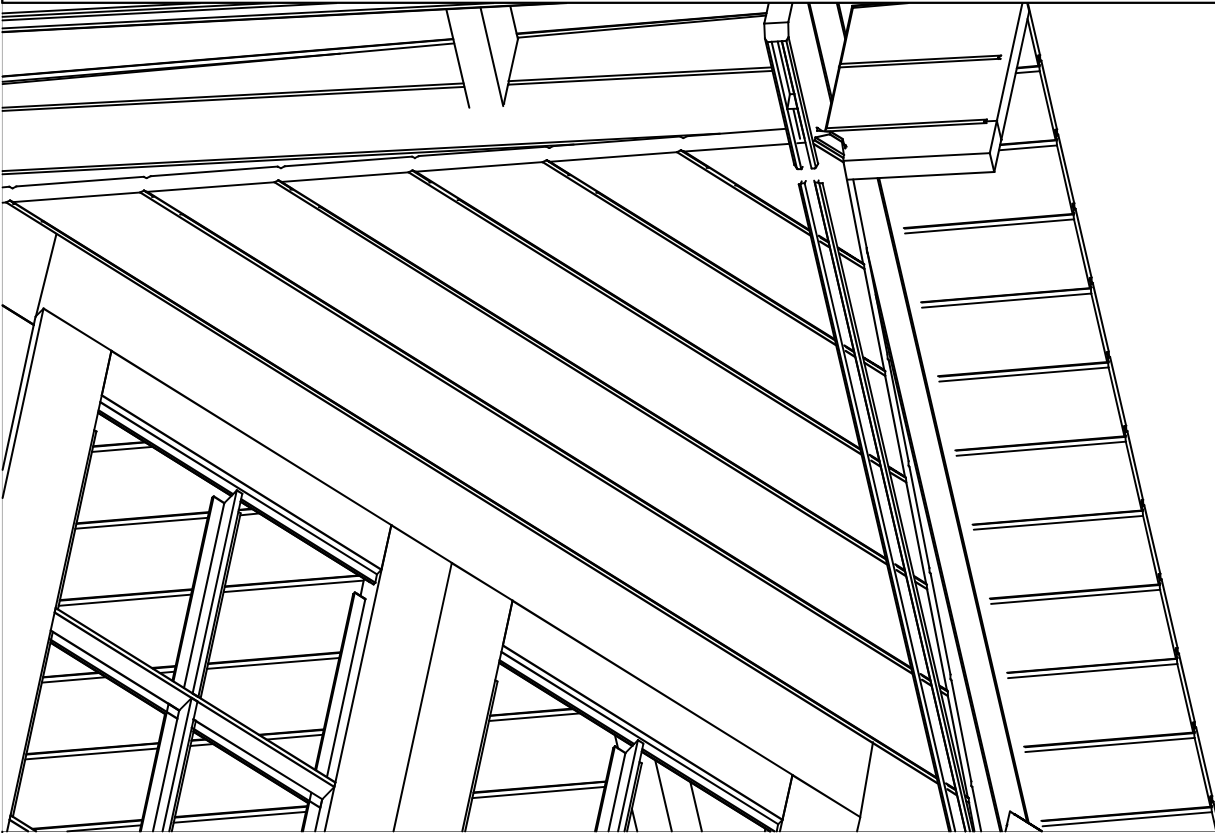

PACKAGE NR.:

MNFCT. ORDER NR.:

CONTROL 1

CONTROL 2

SIGNATURE

SIGNATURE

PAGE/PAGES: **7/7**

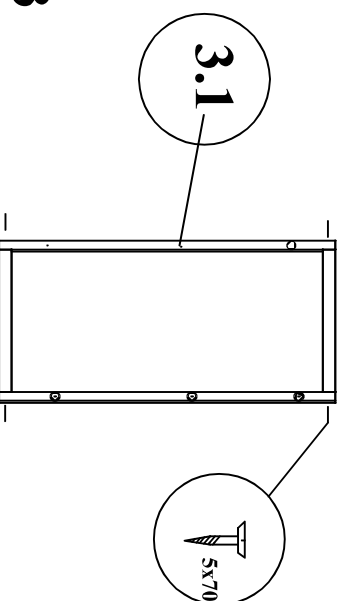
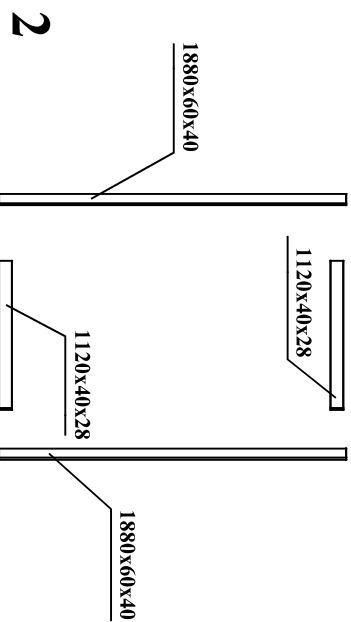
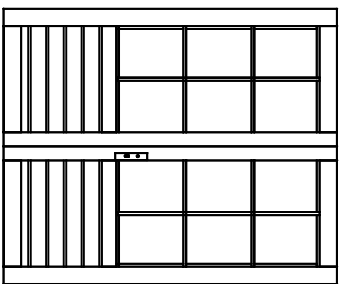

3.1

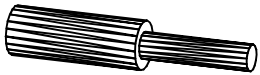

4

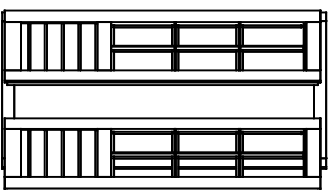

5

