

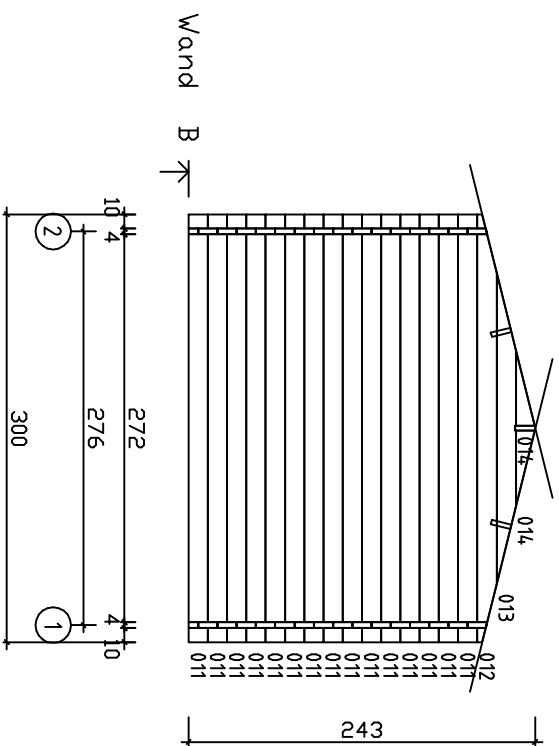

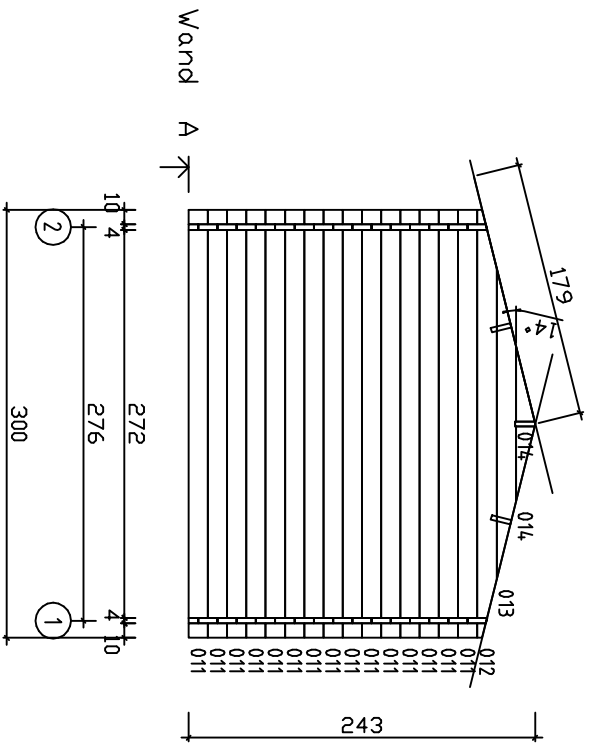

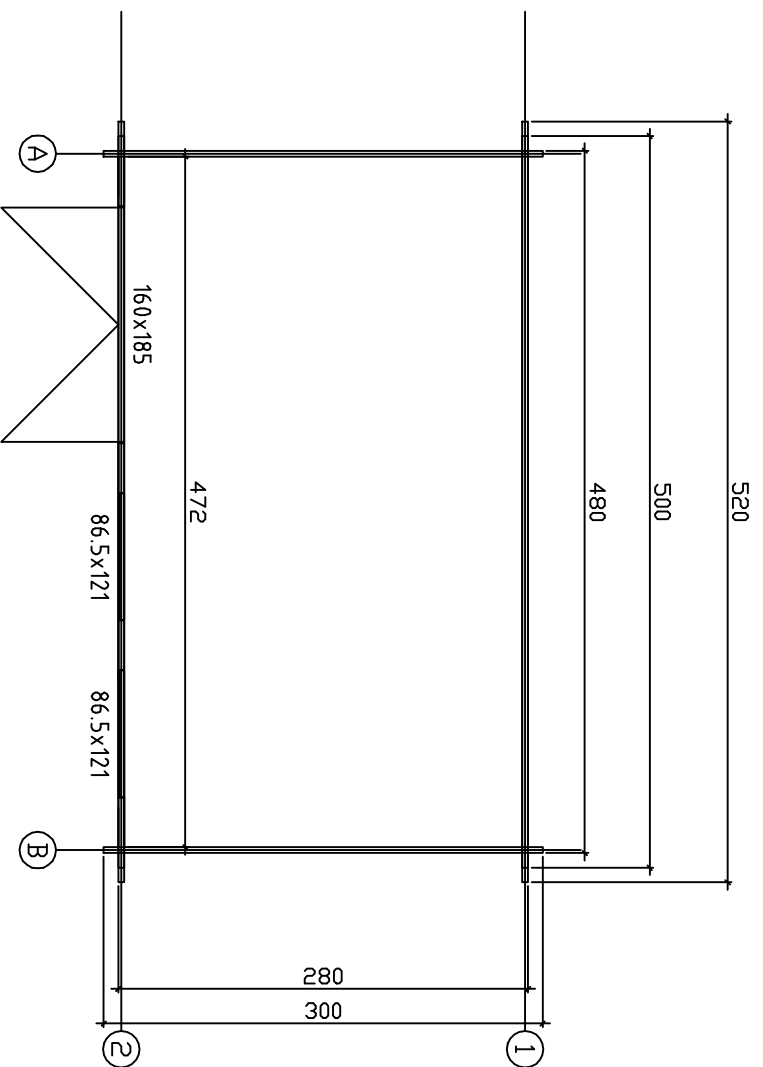

Kood	Aiste	Lent	4
Joonis	Wand 1	Mootkava	1:50
Materjal	4,0x13,5	Kuup.	03.05.2016
Joonestaj	File Aiste.dwg		



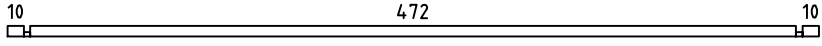
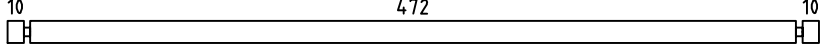
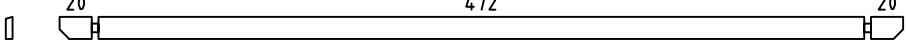

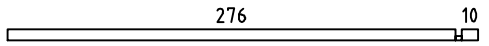

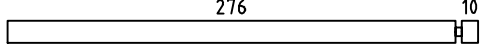

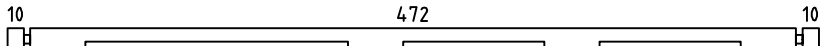
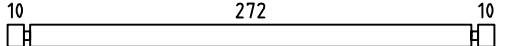
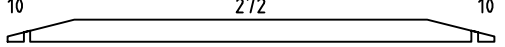
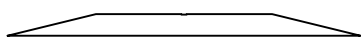
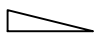
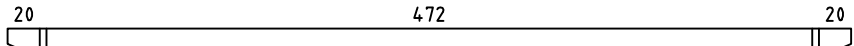
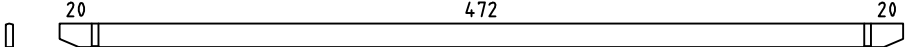
Kood	Aiste	Leht	2
Joonis	Wand A	Mootkava	1:50
Materjal	4,0x13,5	Kuup.	03.05.2016
Joonestias	File Aiste.dwg		

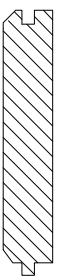

Kood	Aiste	Leht	
Joonis		Mootkava	1:50
Materjal	4,0 × 13,5	Kuup.	03.05.2016
Joonestus		File	Aiste.dwg

Pos	Drawing Aiste	Pcs	Profile (cm)	Length (cm)	
001		1	4x6.8	500	
002		14	4x13.5	500	
003		2	4x13.5	520	
004		1	4x6.8	48	
005		1	4x6.8	290	
006		22	4x13.5	48	
007		4	4x13.5	290	
008		9	4x13.5	34	
009		9	4x13.5	34	
010		1	4x13.5	500	
011		30	4x13.5	300	
012		2	4x13.5	300	
013		2	4x13.5	217.6	
014		4	4x13.1	52.7	
PR1		2	4.3x14.5	520	
PR2		1	4.3x14.5	520	
	WINDOW 86.5x121	2			
	DOOR 160x185	1			
Kood Aiste		Materjal		File Aiste.dwg	Leht 1/2

Pos	Drawing Aiste	Pcs	Profile (cm)	Length (cm)
018	ROOF BOARDS/DACHBRETTER/VOLIGE 	94 77	11.2x1.6 13.7x1.6	179 179
019	ROOF EDGE REINFORCEMENT / TRAUFFENLEISTE / TASSEAU 	2	2.6x3.2	520
020	ROOF SIDE BOARDS / TRAUFFENBRETT / PLANCHE DE RIVE 	2	1.8x6	520
021	FASCIA BOARD / GIEBELBLENDE / PLANCHE DE RIVE (FACADE) 	4	1.8x12.0	183
022	FASCIA BOARD / GIEBELBLENDE / PLANCHE DE RIVE (FACADE) 	4	1.8x6.0	183
023	DIAMOND / RAUTE / DIAMANT 	2	1.8x12	120
Kood	Aiste	Materiaal	File Aiste.dwg	Leht 2/2