

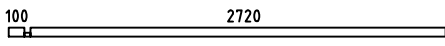

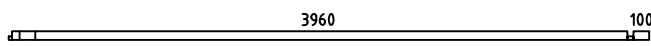

Annette40

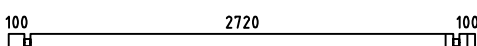

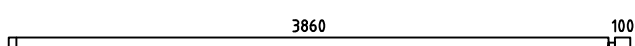
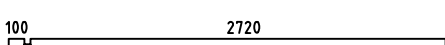
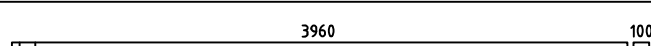
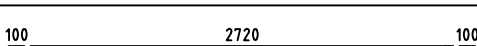
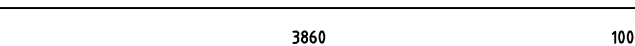
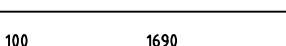
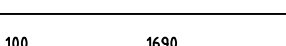

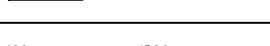
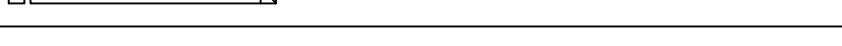
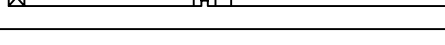
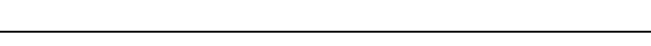
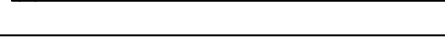
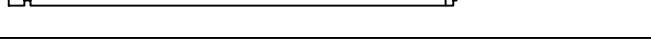
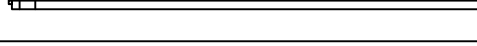
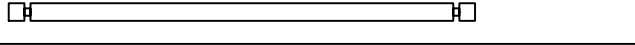
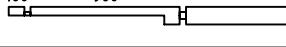
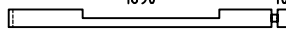

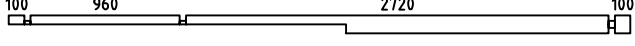
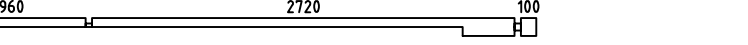



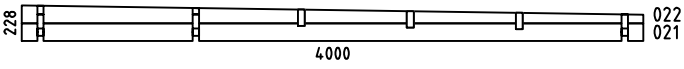
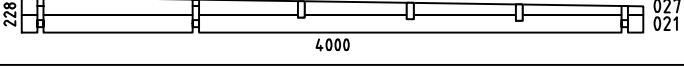

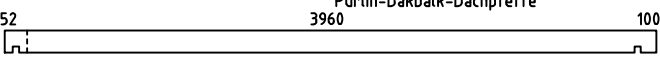
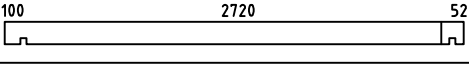
Pos	Specification-Spezifikation-Specificatie	St.	Profile (mm)	Length (mm)
001		1	40x57	2880
002		1	40x57	4120
003		11	40x114	3000
004		11	40x114	4000
005		10	40x114	2880
006		10	40x114	4120
007		1	40x114	3000
008		1	40x114	4000
009		1	40x57	1830
010		11	40x114	1830
011		38	40x114	475
012		21	40x114	475
013		1	40x114	1720
014		1	40x114	5380
015		1	40x41	2880
016		1	40x41	4120
017		1	40x56	2880
018		1	40x56	4120
019		17	40x114	3000
020		1	40x114	4000
023		1	40x114	1830
024		1	40x114	1830
025		1	40x114	4000
026		1	40x114	4000
WA-1		1		

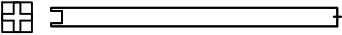
Kood



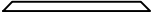

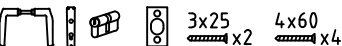
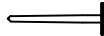

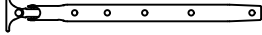
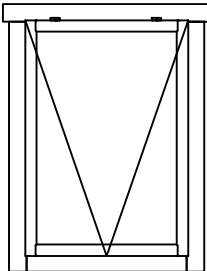
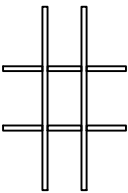

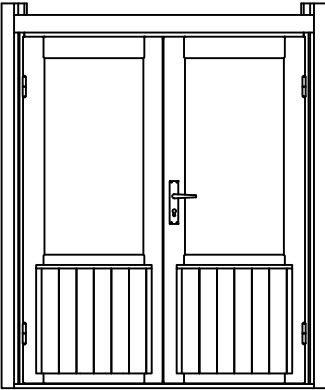
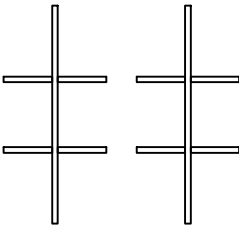

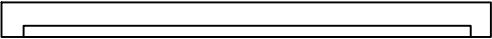
Materjal

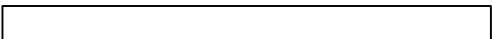
File Annette40.dwg

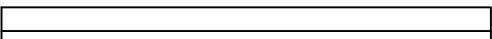
Leht 1/3

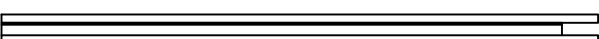
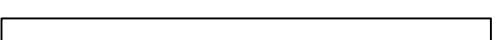
Pos	Specification-Spezifikation-Specificatie	St.	Profile (mm)	Length (mm)
WB-1		1		
WC-1		1		
CS1	CORNICE SUPPORT-TRAGELEISTE FÜR GESIMSE-KROONLIJST STEUNEN BAR 	5	44x70	100
PR2	Purlin-Dakbalk-Dachpfette 	3	44x144	4192
PR1	Purlin-Dakbalk-Dachpfette 	3	44x144	2952
DP-1	Roof board-Dachbrett-Dakplank 	80	88x18	4000
	+POST 85x85 	3		2290
L-1	Cornice-Gesimse-Kroonlijst 	2	20x250	2900
L-2	Cornice-Gesimse-Kroonlijst 	2	20x250	4016
L-3	Cornice-Gesimse-Kroonlijst 	2	20x250	4140
	Diagonal for POST 44x85 	6		500
	Adjustable foot-Stellfuß+Schrauben 4x50 4stück für Post 	3		
PE1	Ceiling Element-Deckenelement-Plafond Element 1 	1	931x1316	
	Double Door Set-Doppeltür Satz-Dubbele Deur Set 	1		
	Nail-Nagel-Spijker 1.2x20 	35	1.2x20	
WD1	Wall Dowel-Wanddübel-Muurplug 	60		
WS1	Window Stay-Fensterfeststelle 	2		
W9N 86.5 X122.5	WINDOW 865x1225  Window Glazing Bar Fenstersprossen Raamroeden 	2		
Kood	Materjal	File	Annette40.dwg	Leht 2/3

Pos	Specification-Spezifikation-Specificatie	St.	Profile (mm)	Length (mm)	
DD6P 14.15 x189.1	<p align="center">DOOR 1415x1891</p> <div style="display: flex; justify-content: space-around; align-items: center;">  <div style="text-align: left;"> <p>Door Glazing Bar Türsprossen Deuroeden</p>  </div> </div>		1		

Pos	Specification-Spezifikation-Specificatie	St.	Profile (mm)	Length (mm)
CORNER DOOR SET				
1	Top Jamb  	1	58x42	1415
2	Threshold  	1	58x42	1415
3-4	Vertical Jamb  	2	58x42	1891
5-6	Post Set 	1+1	42x61	2020
7-8	Cover Slat  	2	40x18	1860
9-10	Casting 	2	18x95	1500
	Screw-Schraube-Schroef 4x60 	16		
	Screw-Schraube-Schroef 5x90 	16		

H = 1.500 m
TOTAL: 24.09 m²

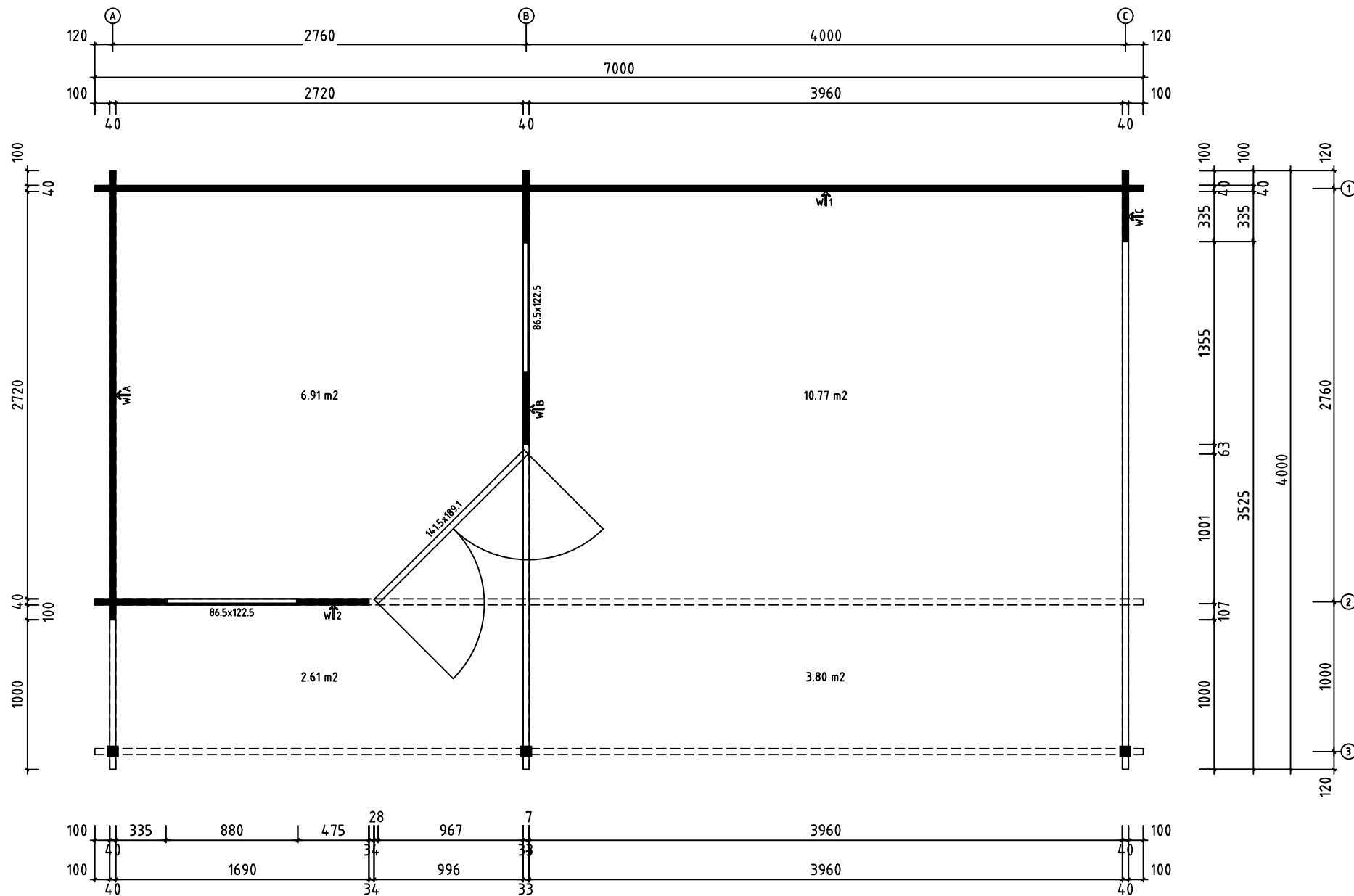

Model	Annette40	Page	PLAN
Client		Scale	1:40
Material	40x114	Date	07.11.2018
Company		File	Annette40.dwg

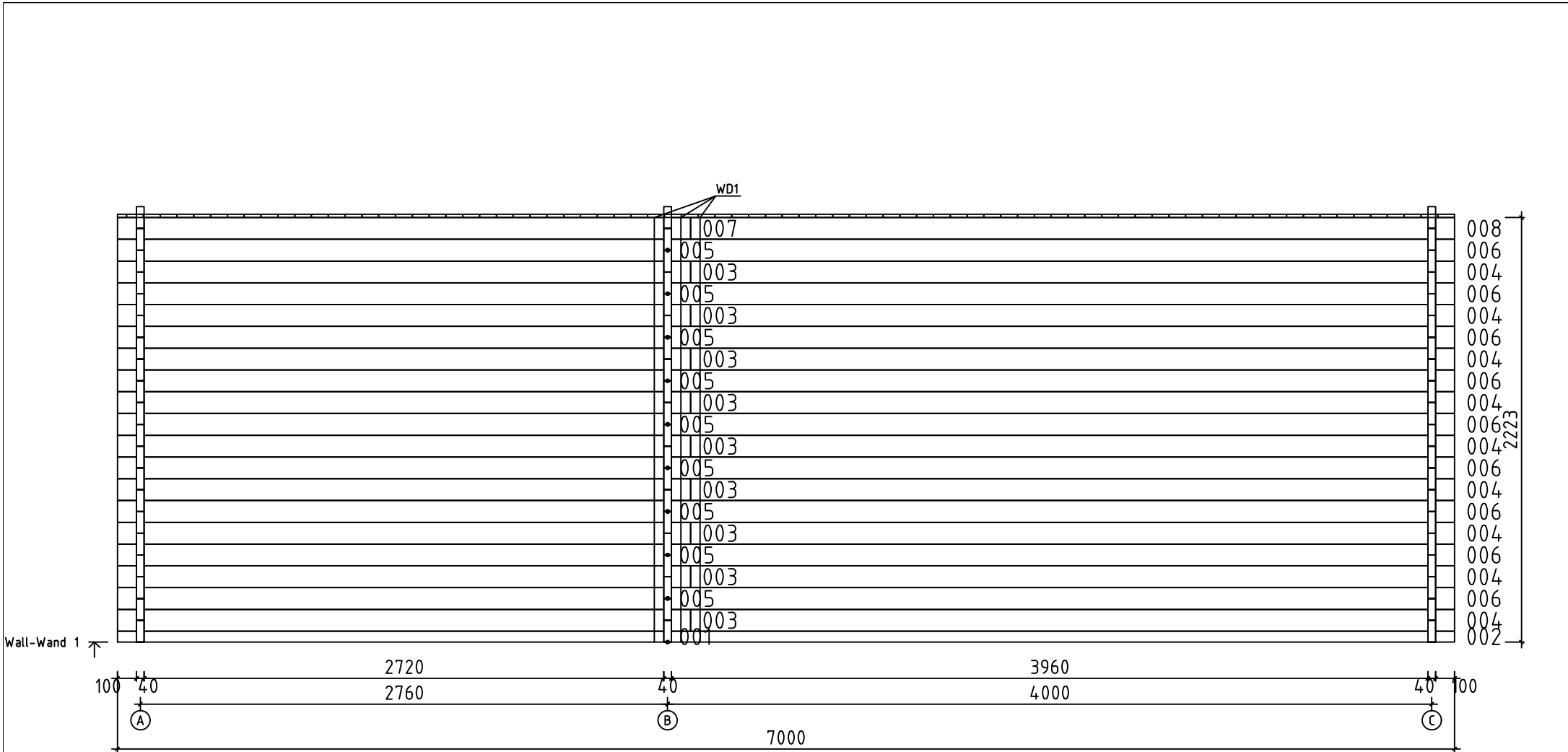

Model	Annette40	Page	6
Client		Scale	1:40
Material	4x11.4	Date	07.11.2018
Company		File	Annette40.dwg

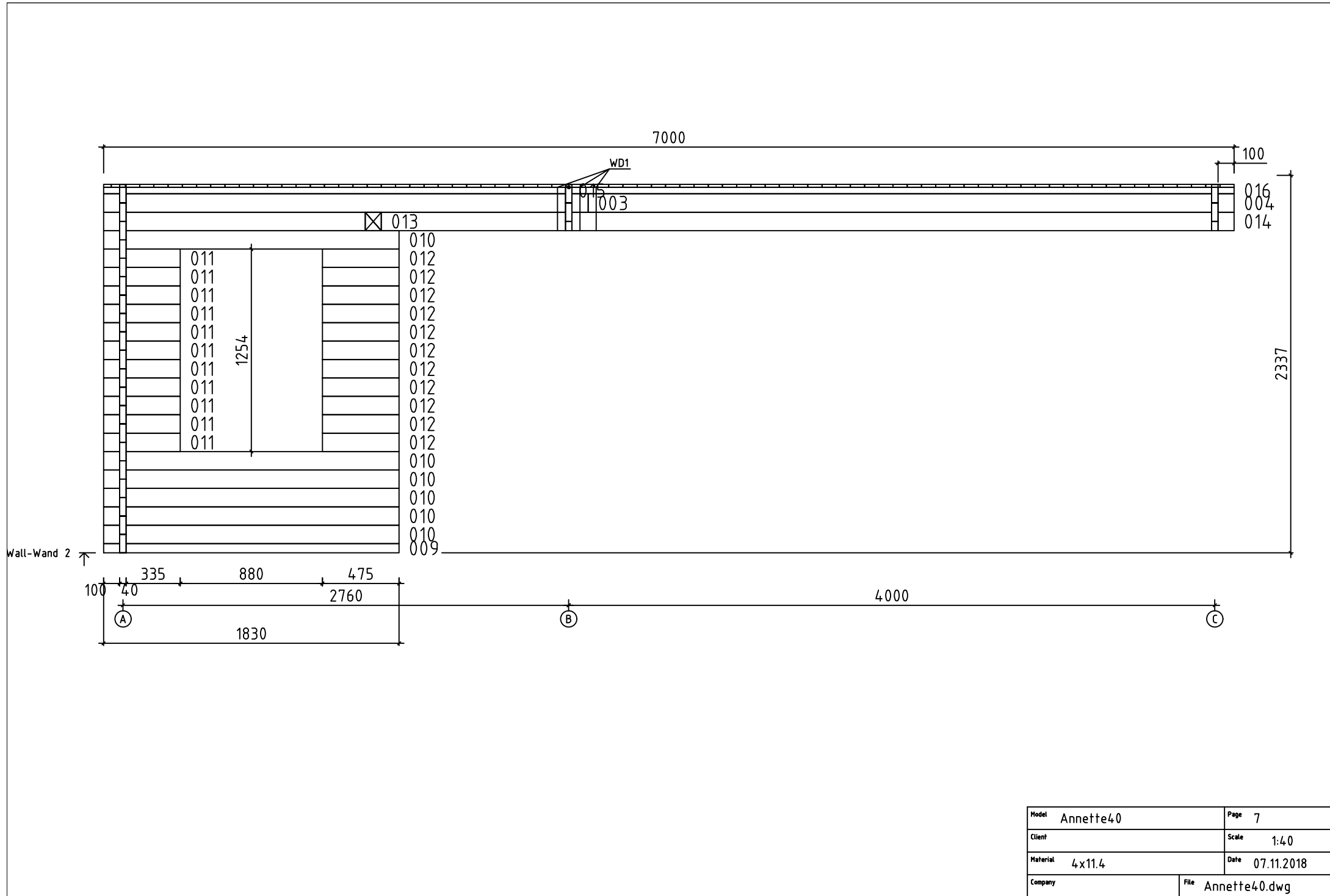

Model	Annette40	Page	7
Client		Scale	1:40
Material	4x11.4	Date	07.11.2018
Company		File	Annette40.dwg

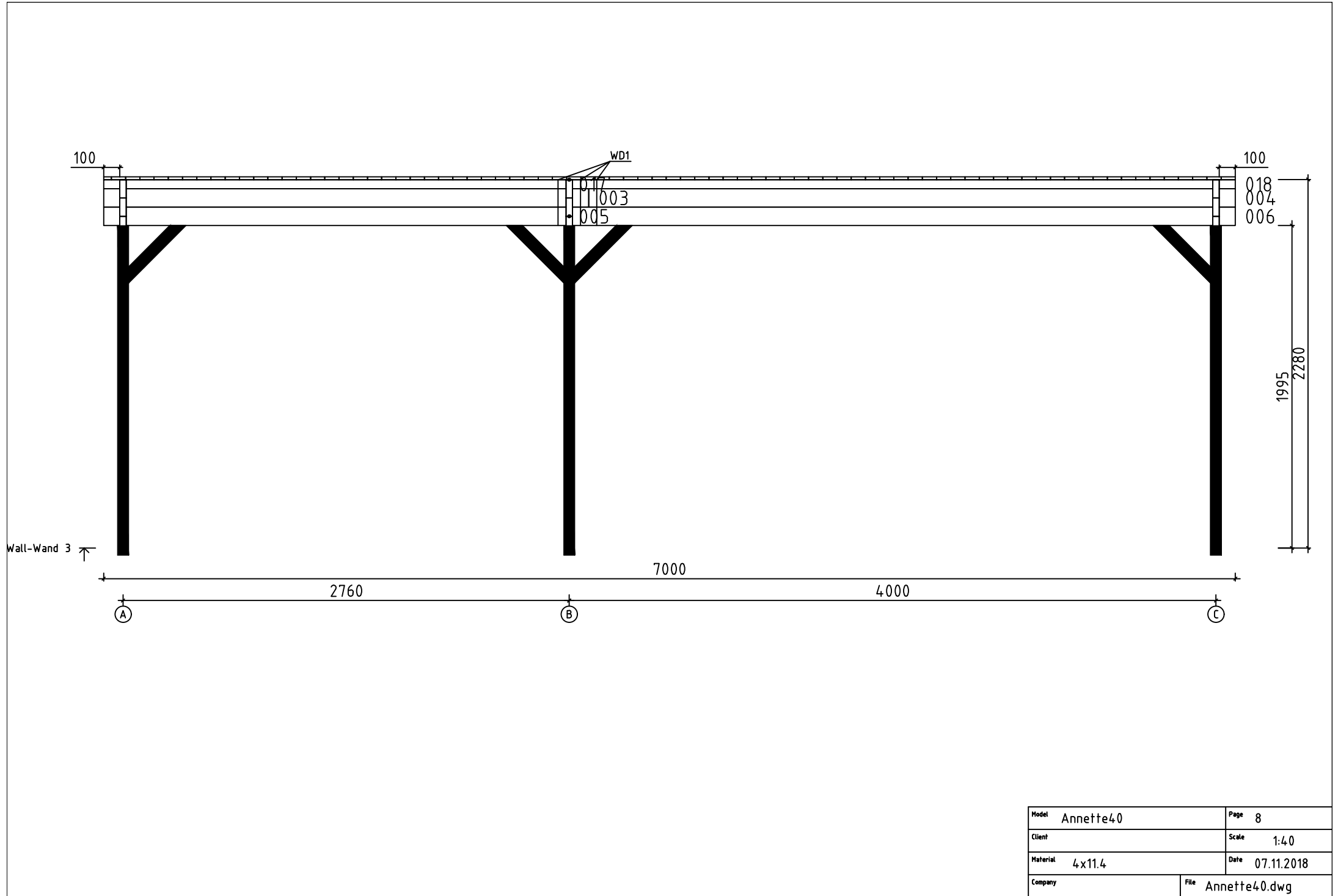

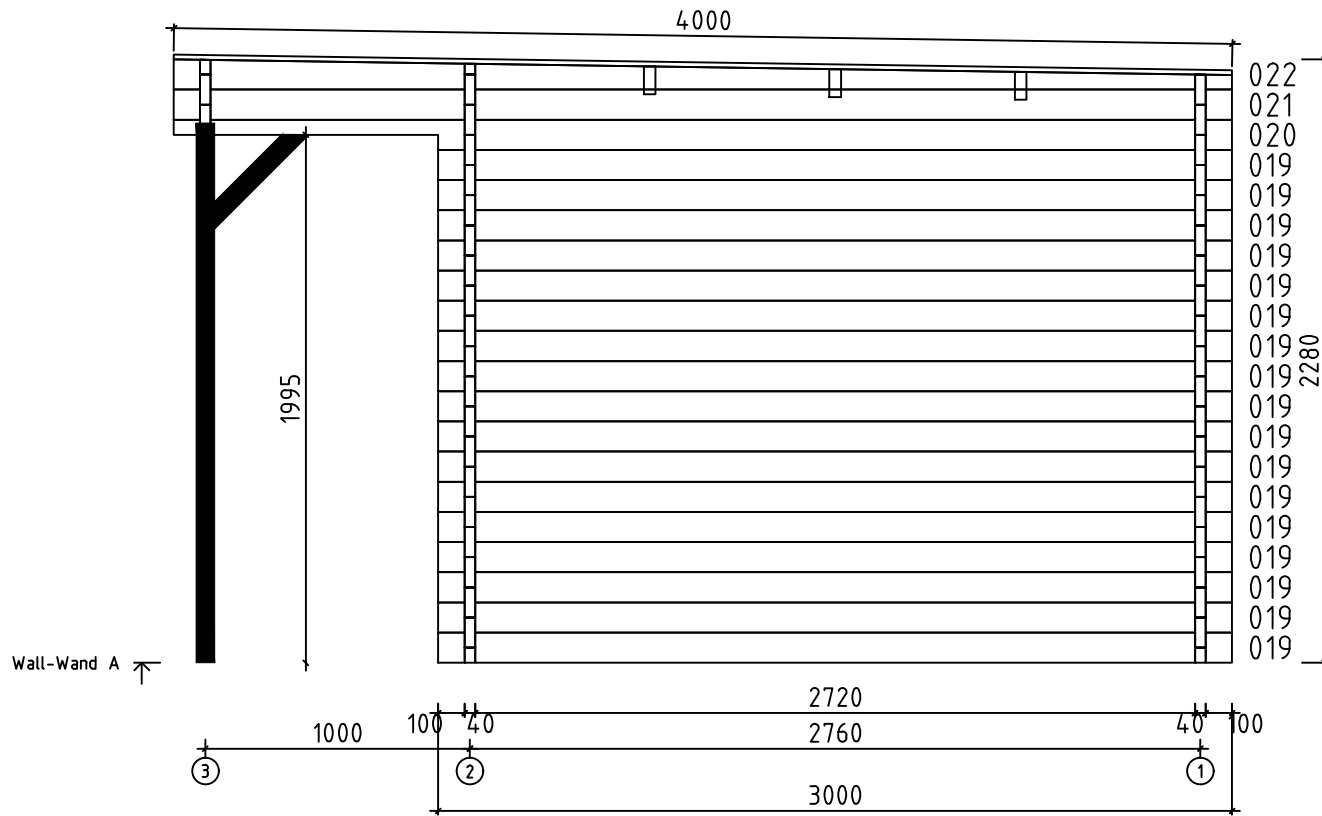

Model	Annette40	Page	2
Client		Scale	1:40
Material	4x11.4	Date	07.11.2018
Company		File	Annette40.dwg

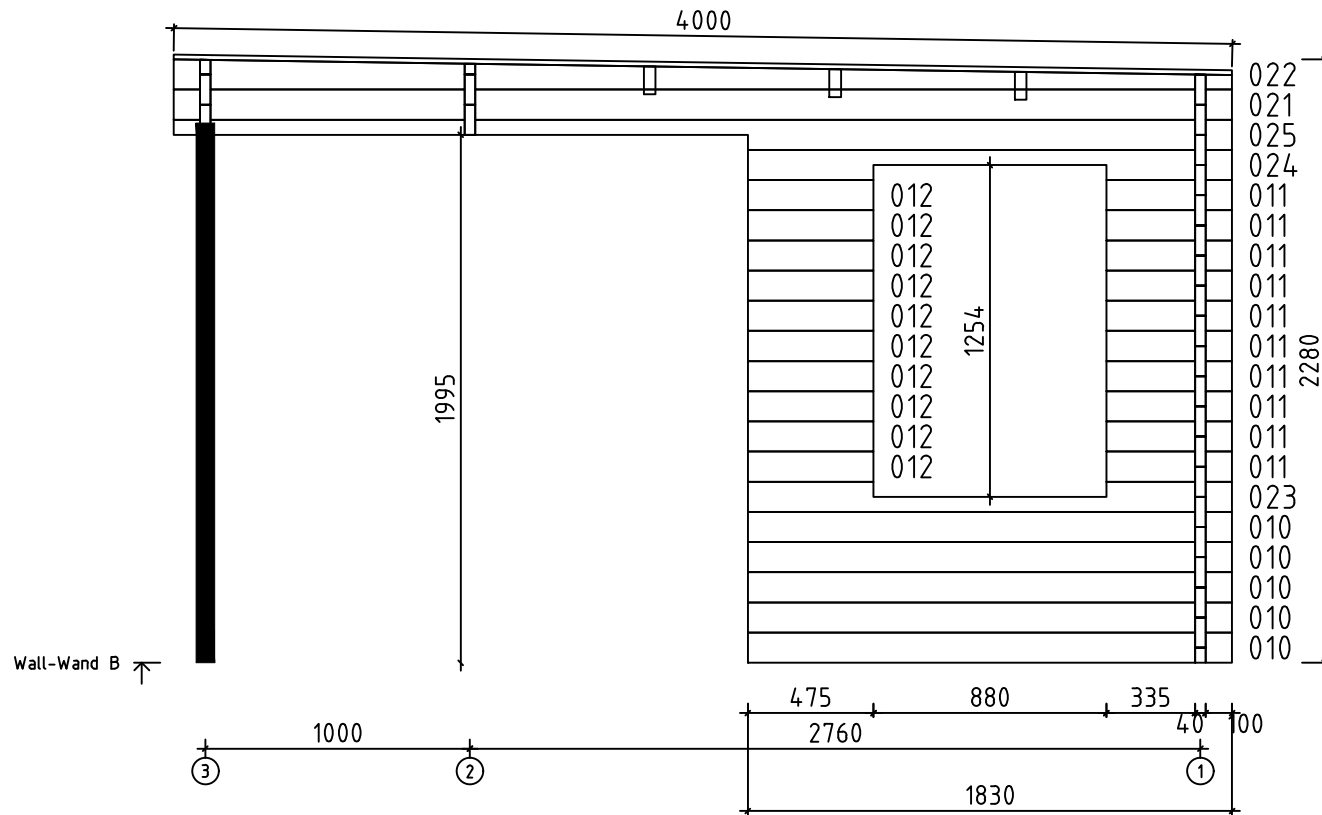

Model	Annette40	Page	3
Client		Scale	1:40
Material	4x11.4	Date	07.11.2018
Company		File	Annette40.dwg

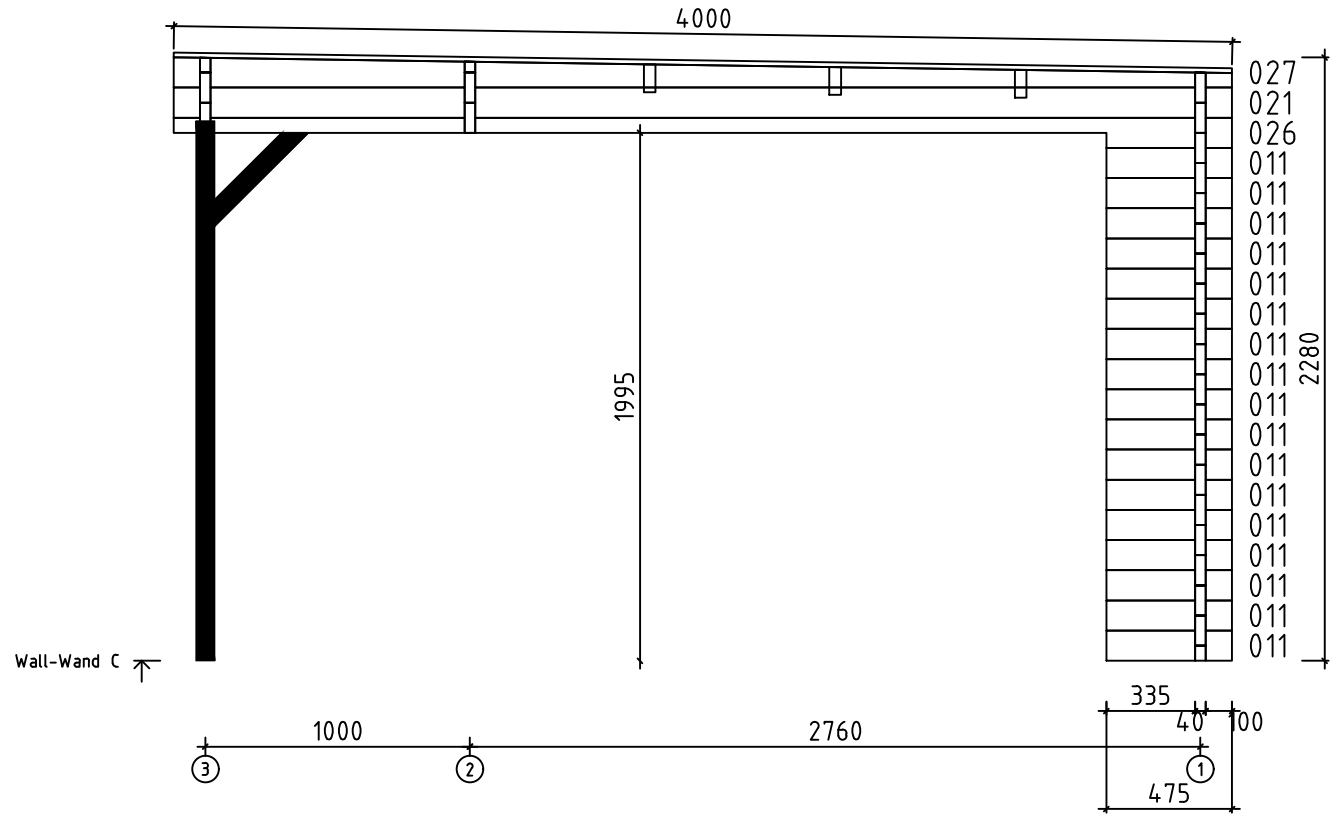

Model	Annette40	Page	4
Client		Scale	1:40
Material	4x11.4	Date	07.11.2018
Company		File	Annette40.dwg

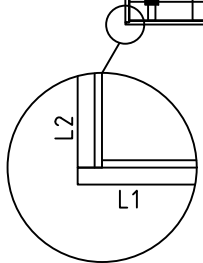
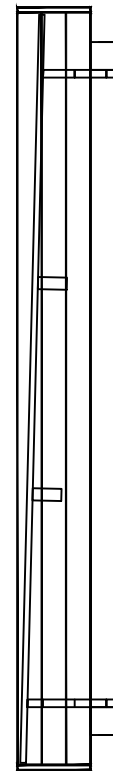
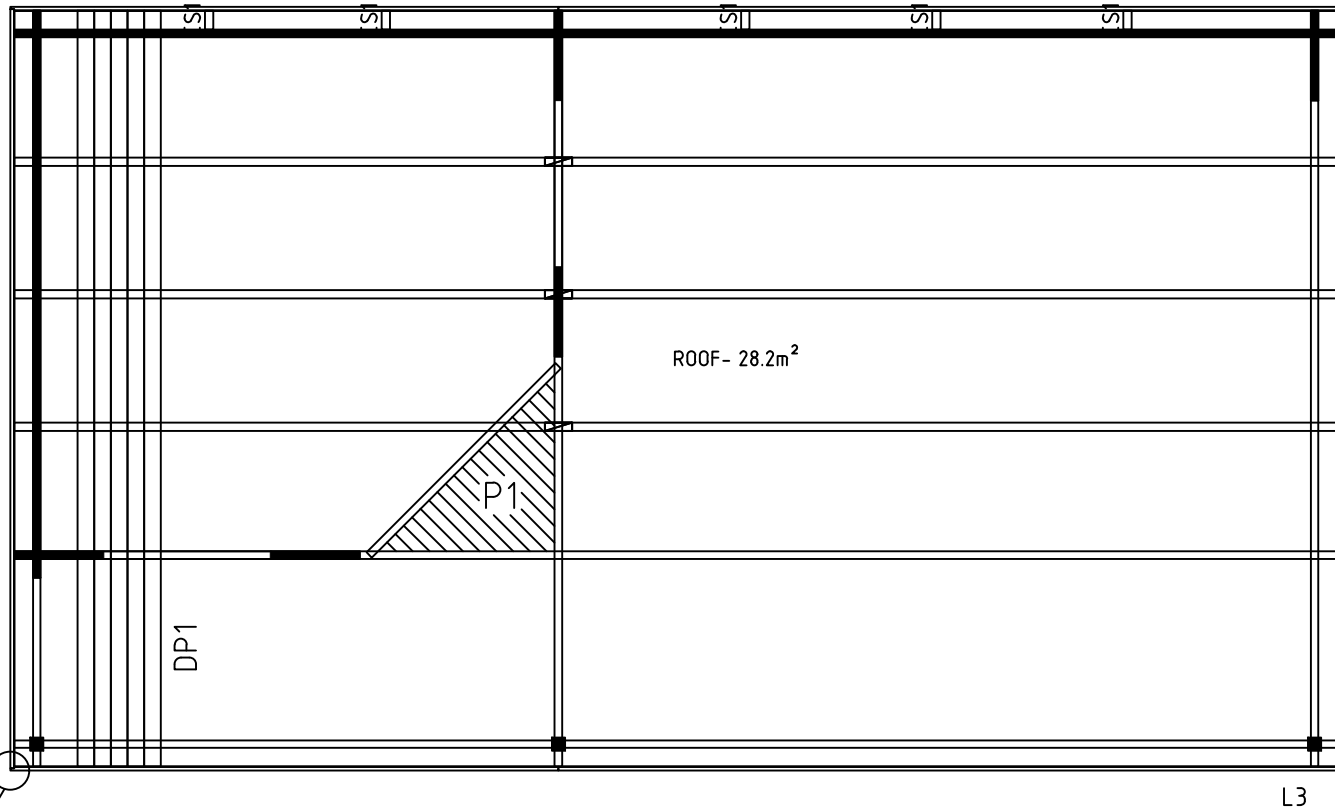

Model	Annette40	Page	ROOF
Client		Scale	1:40
Material	40x114	Date	07.11.2018
Company		File	Annette40.dwg