

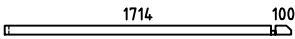

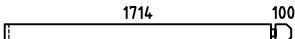

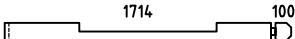





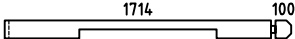
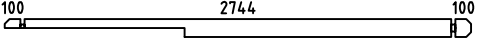
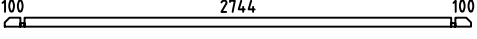
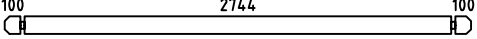
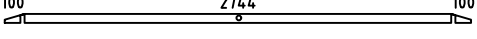
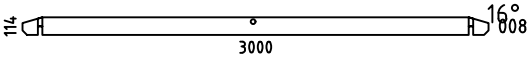
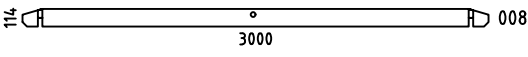
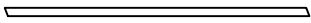
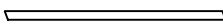



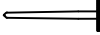

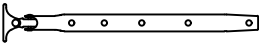

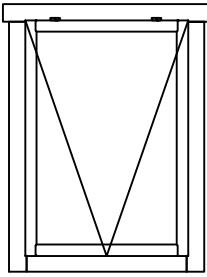
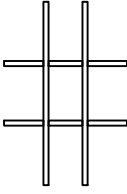
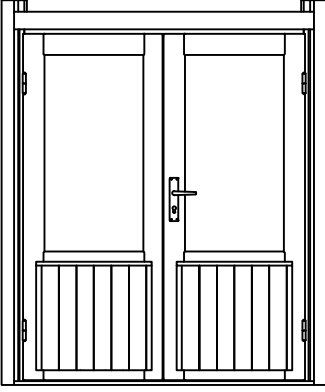
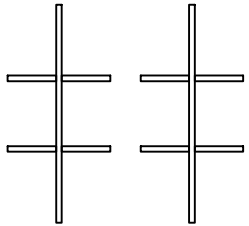
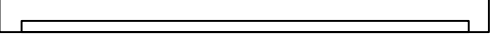

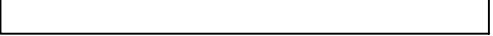
Asmund28-250

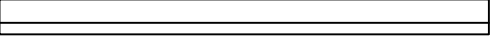
Pos	Specification-Spezifikation-Specificatie	St.	Profile (mm)	Length (mm)
001		1	28x57	1842
002		10	28x114	1842
003		1	28x114	1842
004		21	28x114	480
005		21	28x114	480
006		1	28x114	1842
007		1	28x114	3000
009		1	28x57	3000
010		36	28x114	3000
011		2	28x57	3000
W1-1		1		
W2-1		1		
SR2	RAFTER-DACHSPARREN-DAKSPAR 	4	44x55	1960
SR1	RAFTER-DACHSPARREN-DAKSPAR 	4	44x55	1420
L-1	Eave Slat-Traufenleiste-Afdekljst 	4	40x18	3250
DE1	Roof Panel-Dach Elemente-Dakpanelen 	4+4	1620x1560	
PE1	Ceiling Element-Deckenelement-Plafond Element 1 	1	931x1316	
	Double Door Set-Doppeltür Satz-Dubbele Deur Set  3x25 x2 4x60 x4	1		
	Nail-Nagel-Spijker 1.2x20 	30	1.2x20	
N1	Ridge piece-Firstelement-Nokstuk 	1		
	Screw-Schraube-Schroef 4x60 	70		
WS1	Window Stay-Fensterfeststelle 	2		
HS1	Wood Bolt set-Holzschraubesatz-Hout Bout 8x80 	4		
Kood	Materjal	File	Asmund28-250.dwg	Leht 1/2

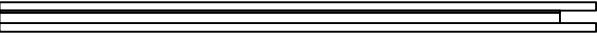
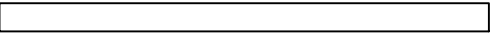
Pos	Specification-Spezifikation-Specificatie			St.	Profile (mm)	Length (mm)
W9N 86.5 x122.5	<p>WINDOW 865x1225</p>  <p>Window Glazing Bar Fenstersprossen Raamroeden</p> 			2		
DD6P 141 .5x184	<p>DOOR 1415x1840</p>  <p>Door Glazing Bar Türsprossen Deuroeiden</p> 			1		
CORNER DOOR SET						
1	Top Jamb			1	58x42	1415
2	Threshold			1	58x42	1415
3-4	Vertical Jamb			2	58x42	1840
5-6	Post Set			1+1	42x61	1970
7-8	Cover Slat			2	40x18	1810
9-10	Casting			2	18x95	1500
	Screw-Schraube-Schroef 4x60			16		
	Screw-Schraube-Schroef 5x90			16		
Kood	Materjal	File	Asmund28-250.dwg	Leht	2/2	

H = 1.500 m  
TOTAL: 7.05 m<sup>2</sup>

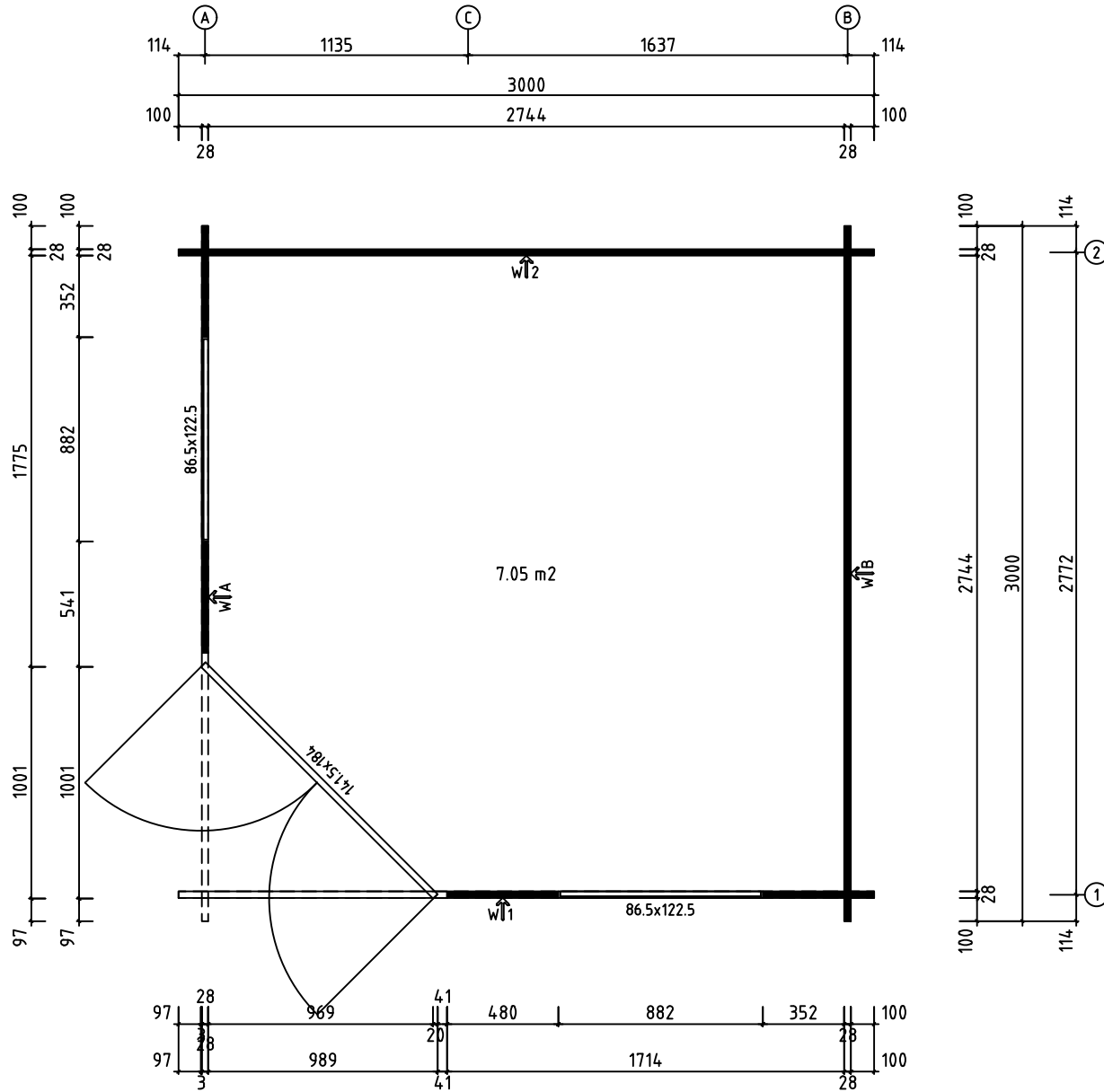

Model	Asmund28-250	Page	PLAN
Client		Scale	1:20
Material	28x114	Date	06.11.2018
Company		File	Asmund28-250.dwg

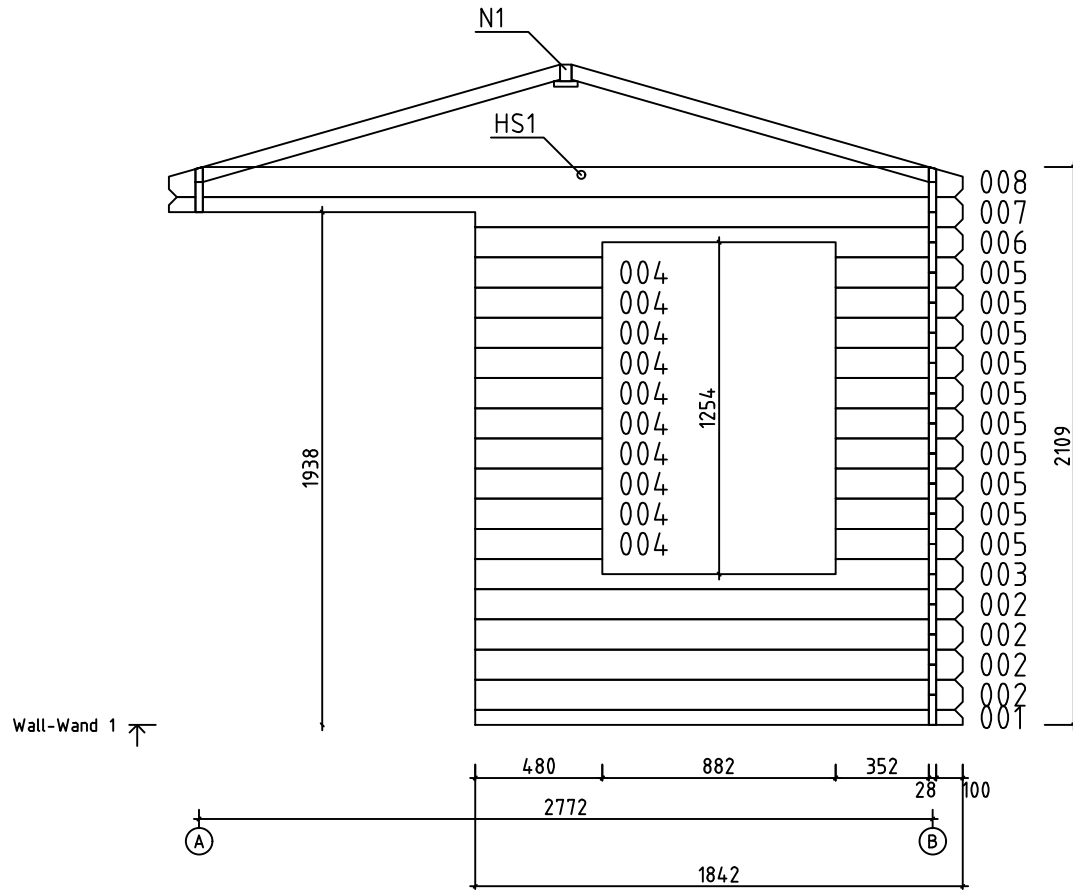

Model	Asmund28-250	Page	5
Client		Scale	1:20
Material	2.8x11.4	Date	06.11.2018
Company		File	Asmund28-250.dwg

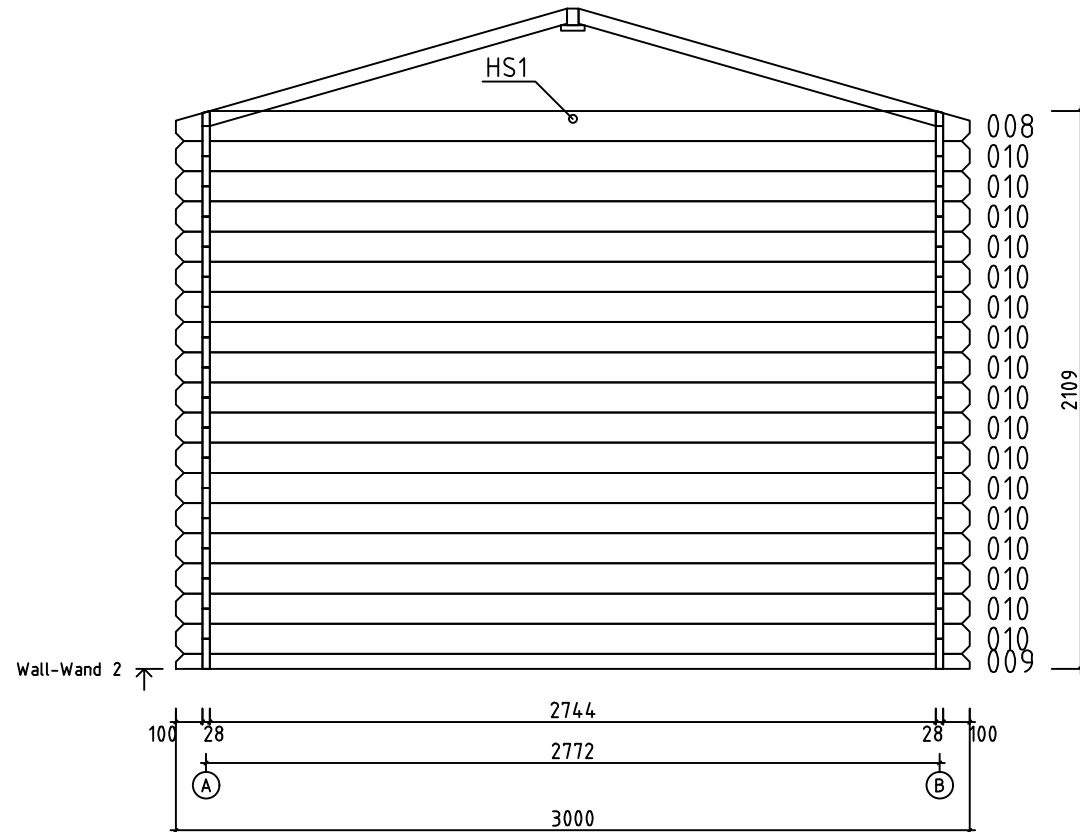

Model	Asmund28-250	Page	6
Client		Scale	1:20
Material	2.8x11.4	Date	06.11.2018
Company		File	Asmund28-250.dwg

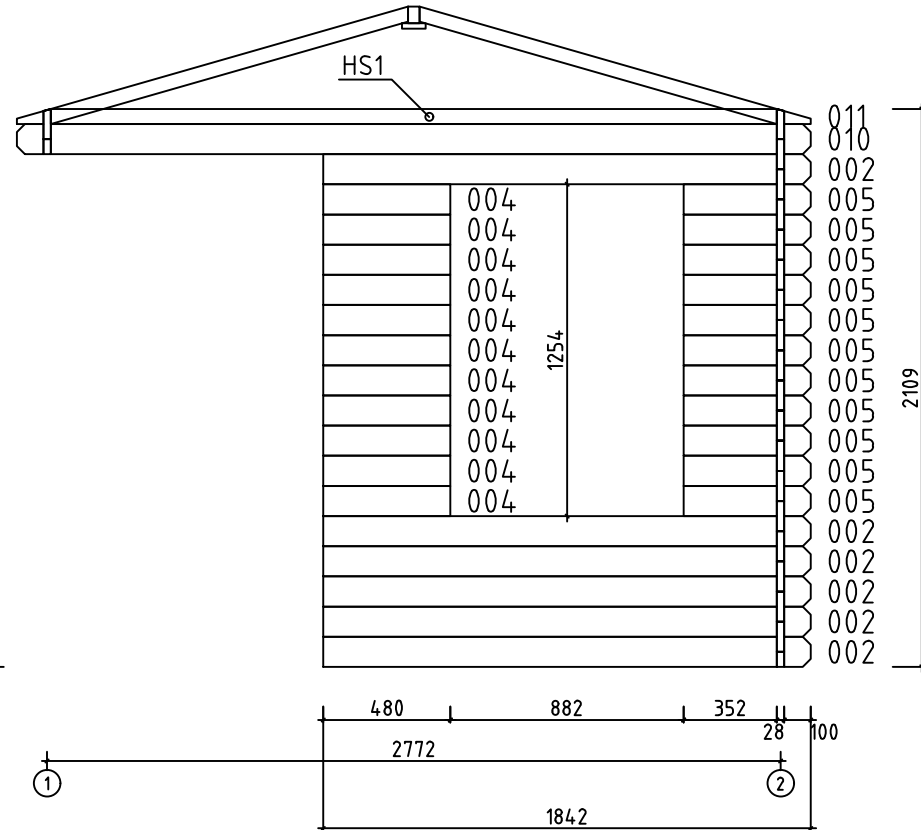

Wall-Wand A ↗

Model	Asmund28-250	Page	2
Client		Scale	1:20
Material	2.8x11.4	Date	06.11.2018
Company		File	Asmund28-250.dwg

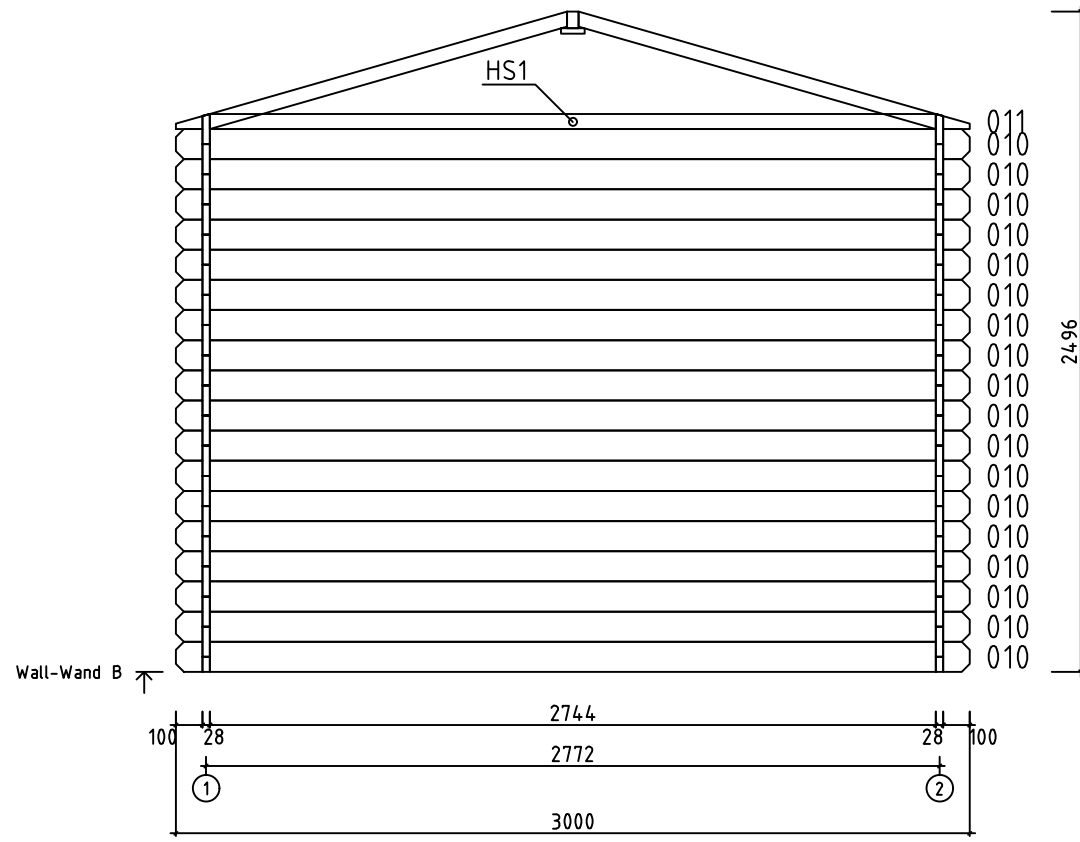

Model	Asmund28-250	Page	3
Client		Scale	1:20
Material	2.8x11.4	Date	06.11.2018
Company		File	Asmund28-250.dwg



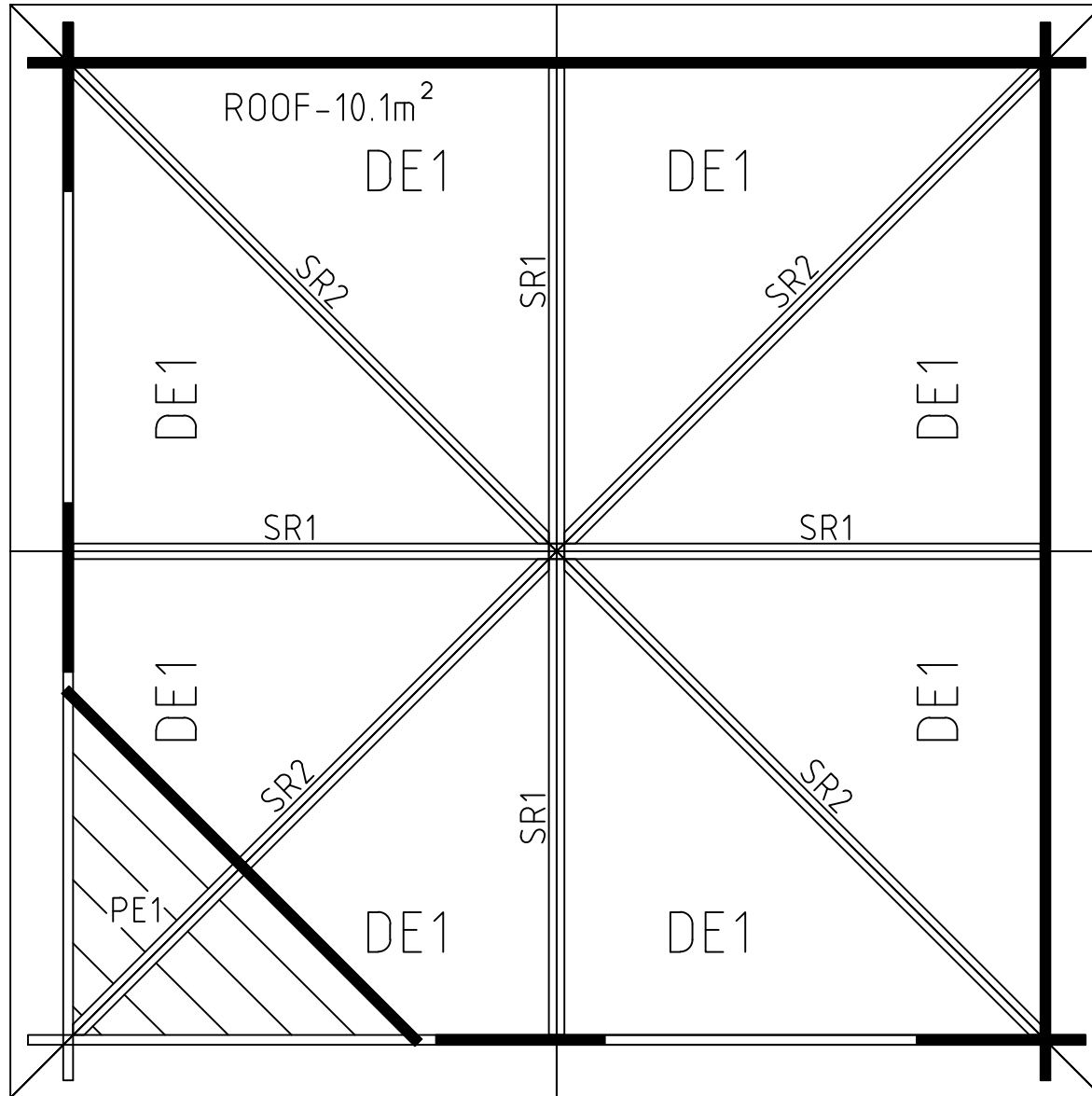

Model	Asmund28-250	Page	ROOF
Client		Scale	1:20
Material	28x114	Date	06.11.2018
Company		File	Asmund28-250.dwg

The guide is illustrative. This guide is not project specification.  
Der Leitfaden ist illustrativ. Dieser Leitfaden ist keine Projektspezifikation.  
De gids is illustratief. Deze gids is geen projectspecificatie.

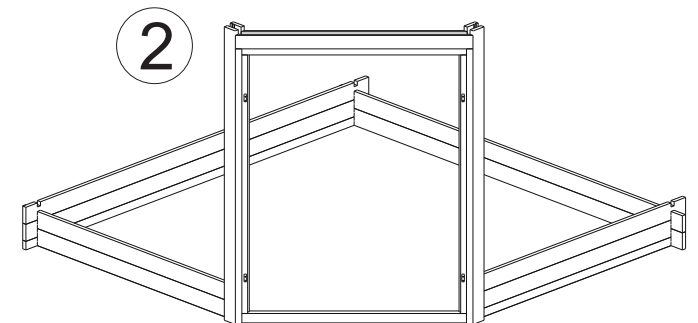
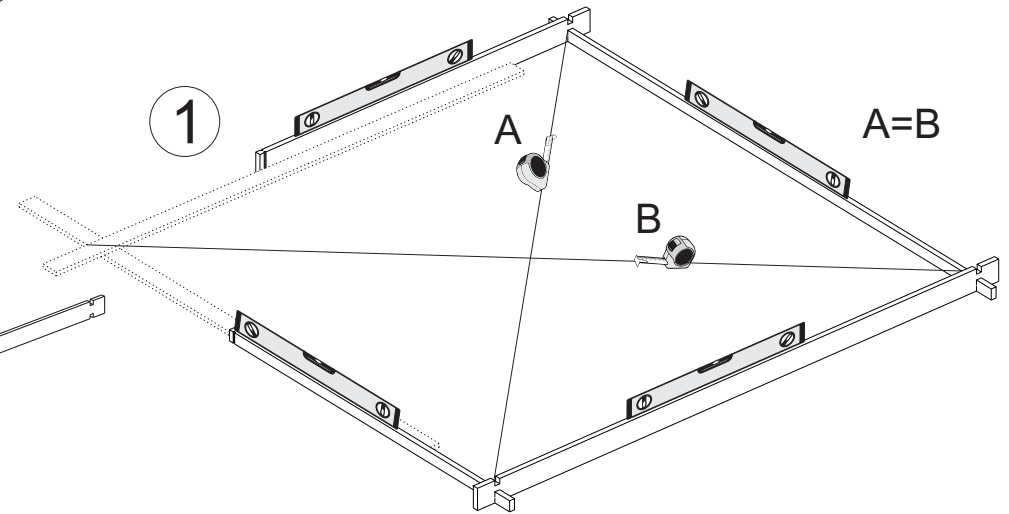
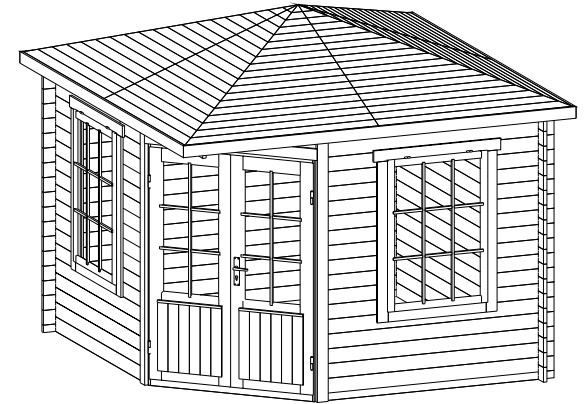
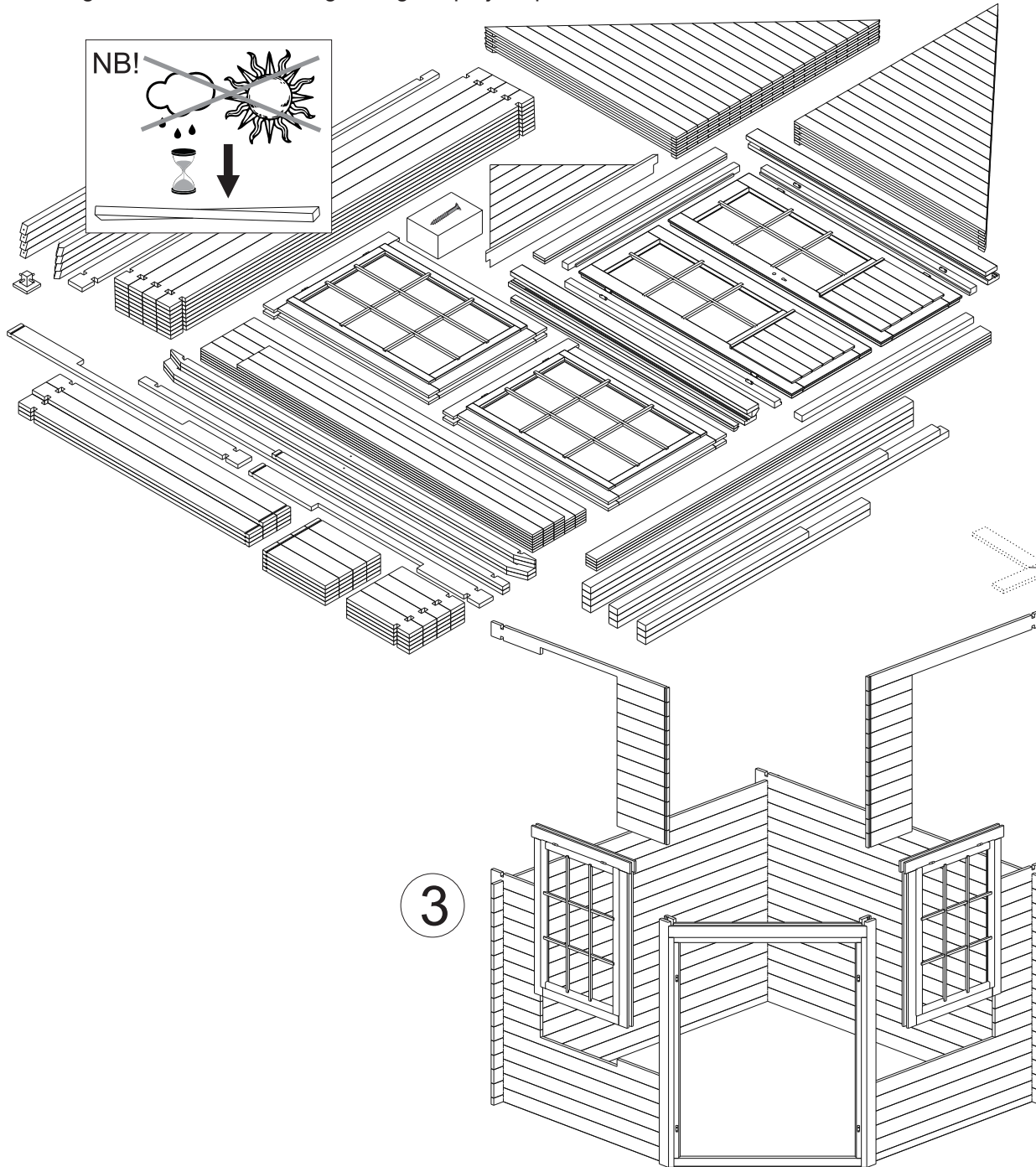

3

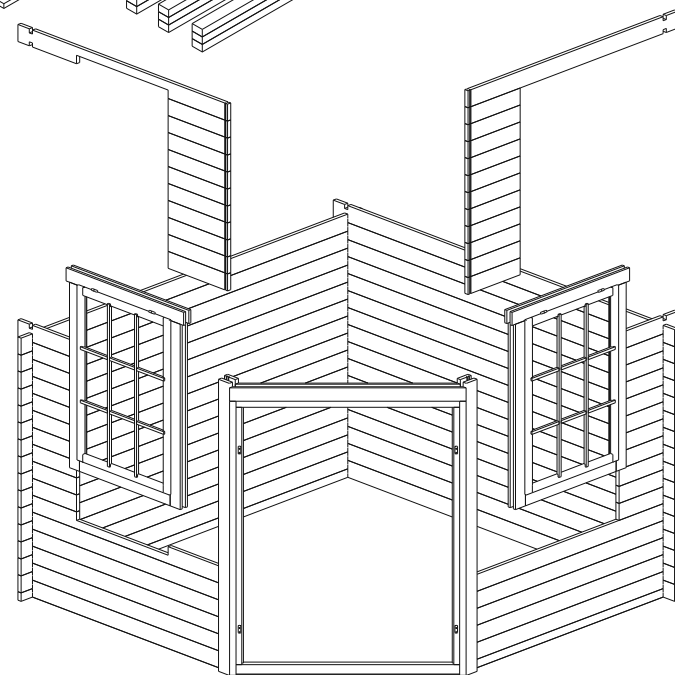

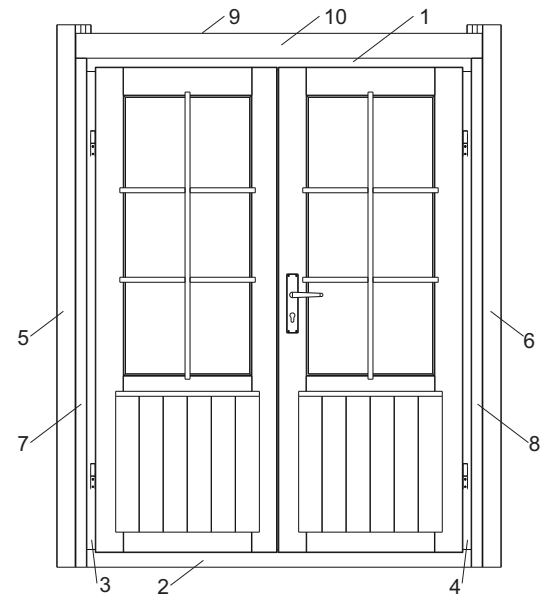
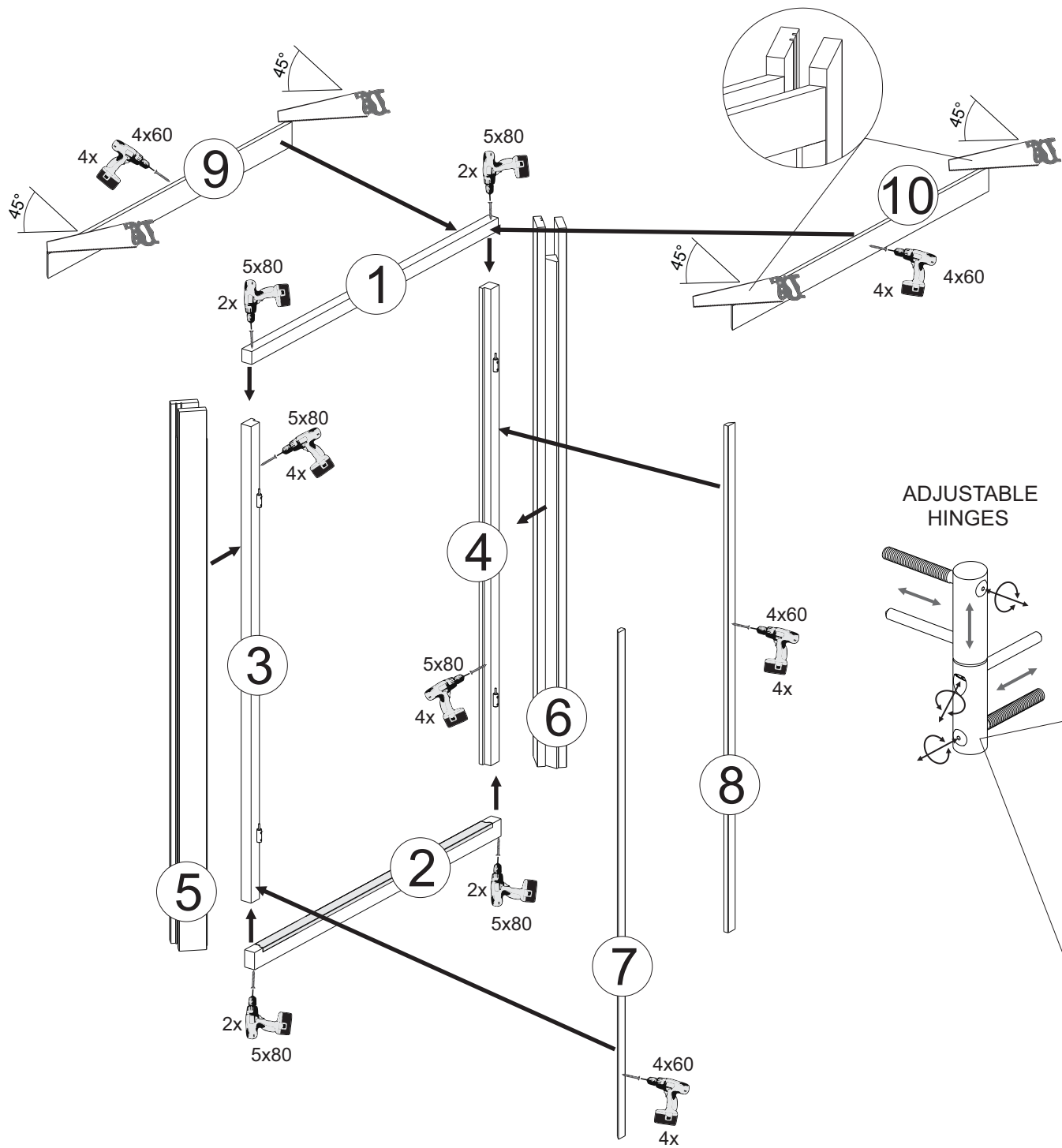

**ADJUSTABLE HINGES**

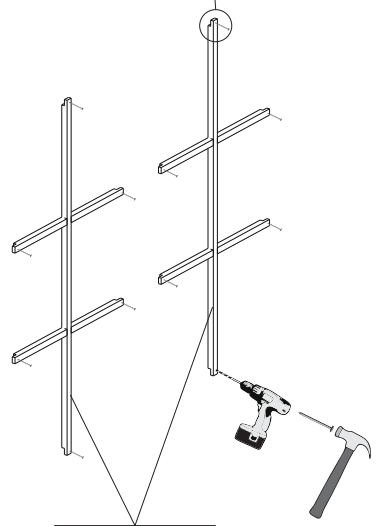
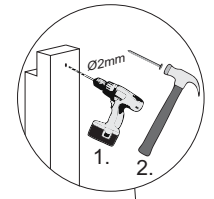
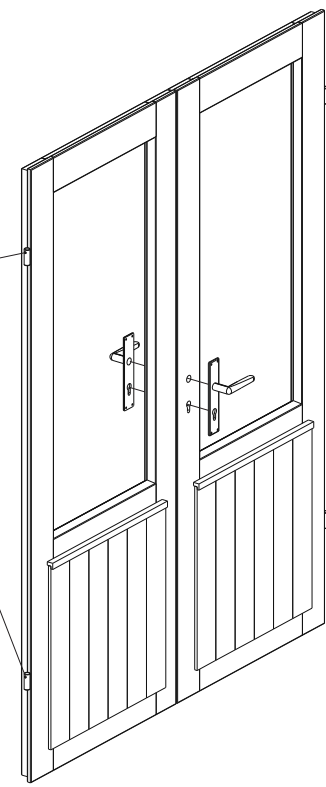
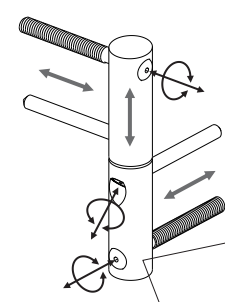

**OPTIONS!**

4

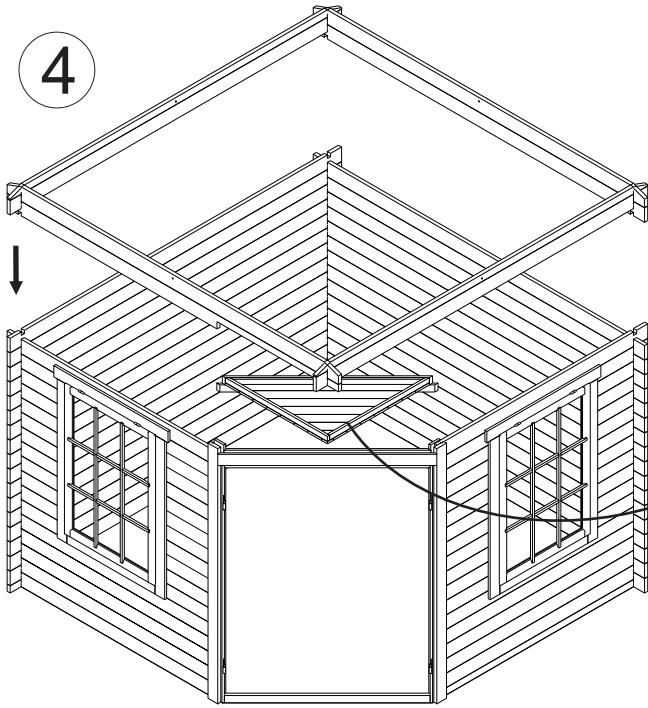

5

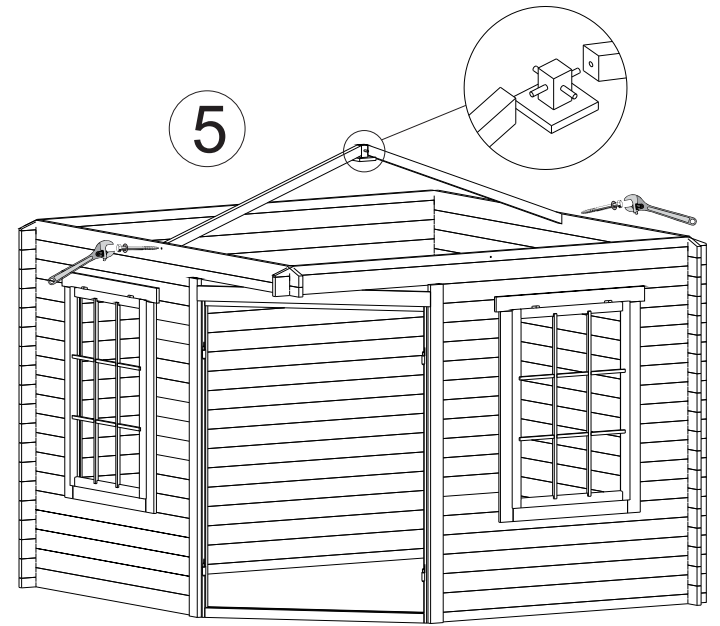

6

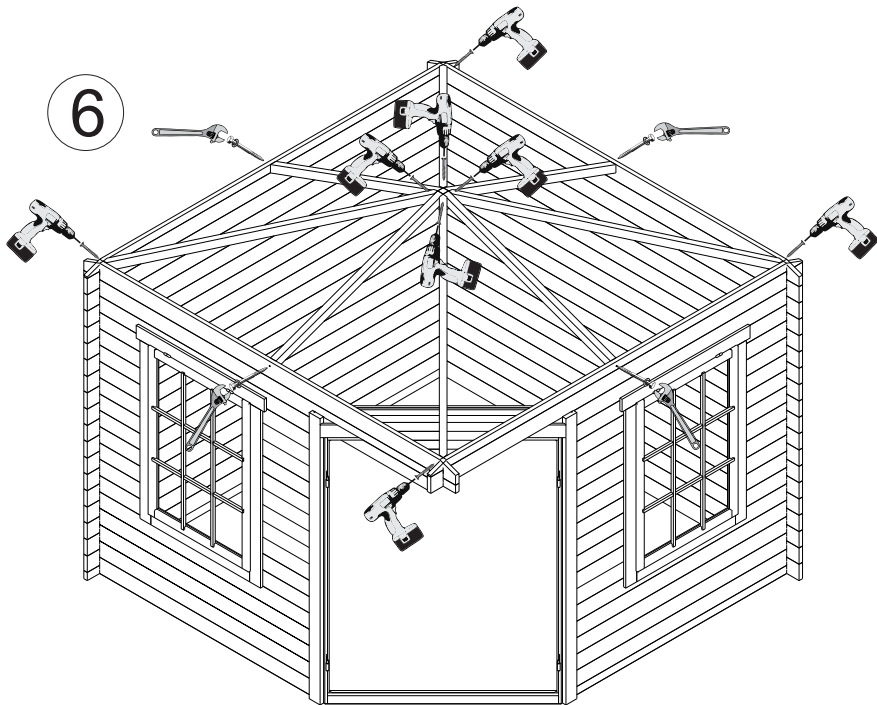

7

