

Name	Bertil 300x300+500/44		
Zeichnung/Drawing	3D		
Profil/Profile	4.4x13.5	Datum/Date	25.08.2020

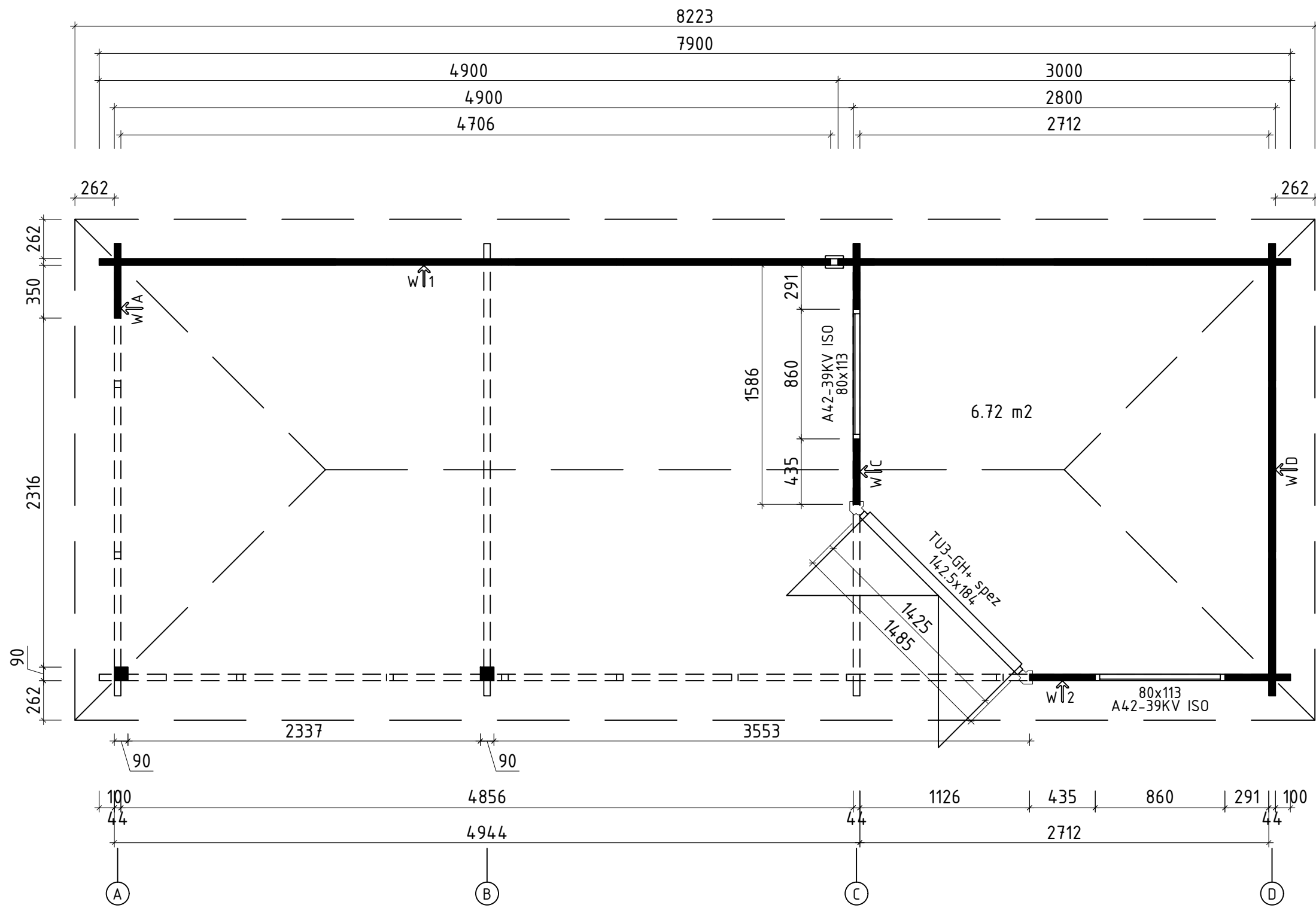

Name	Bertil 300x300+500/44		
Zeichnung/Drawing	Grundplan; Plan		
Profil/Profile	4.4x13.5	Datum/Date	25.08.2020

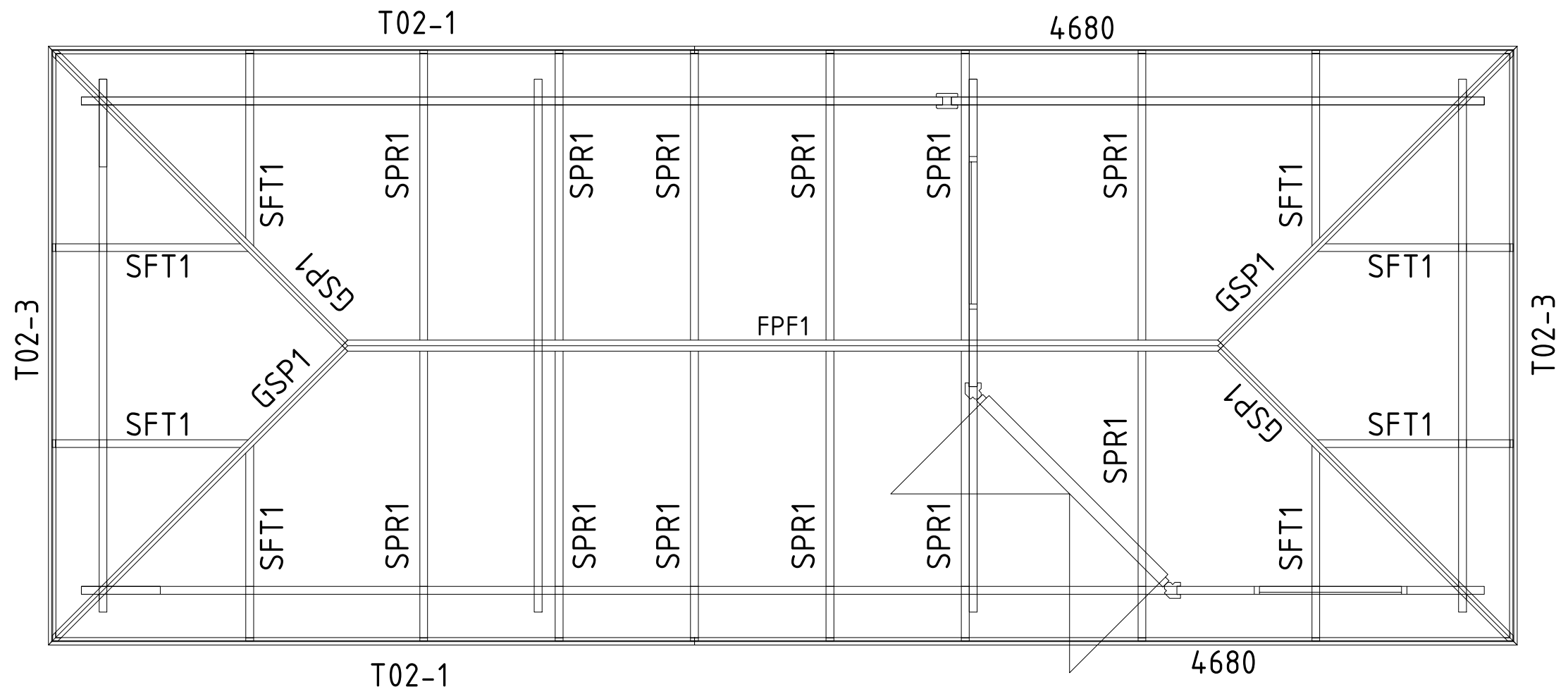

Name	Bertil 300x300+500/44		
Zeichnung/Drawing	Dachplan; Roof plan		
Profil/Profile	4.4x13.5	Datum/Date	25.08.2020

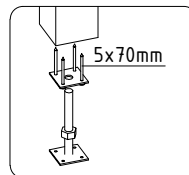
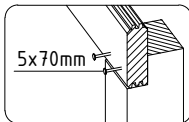
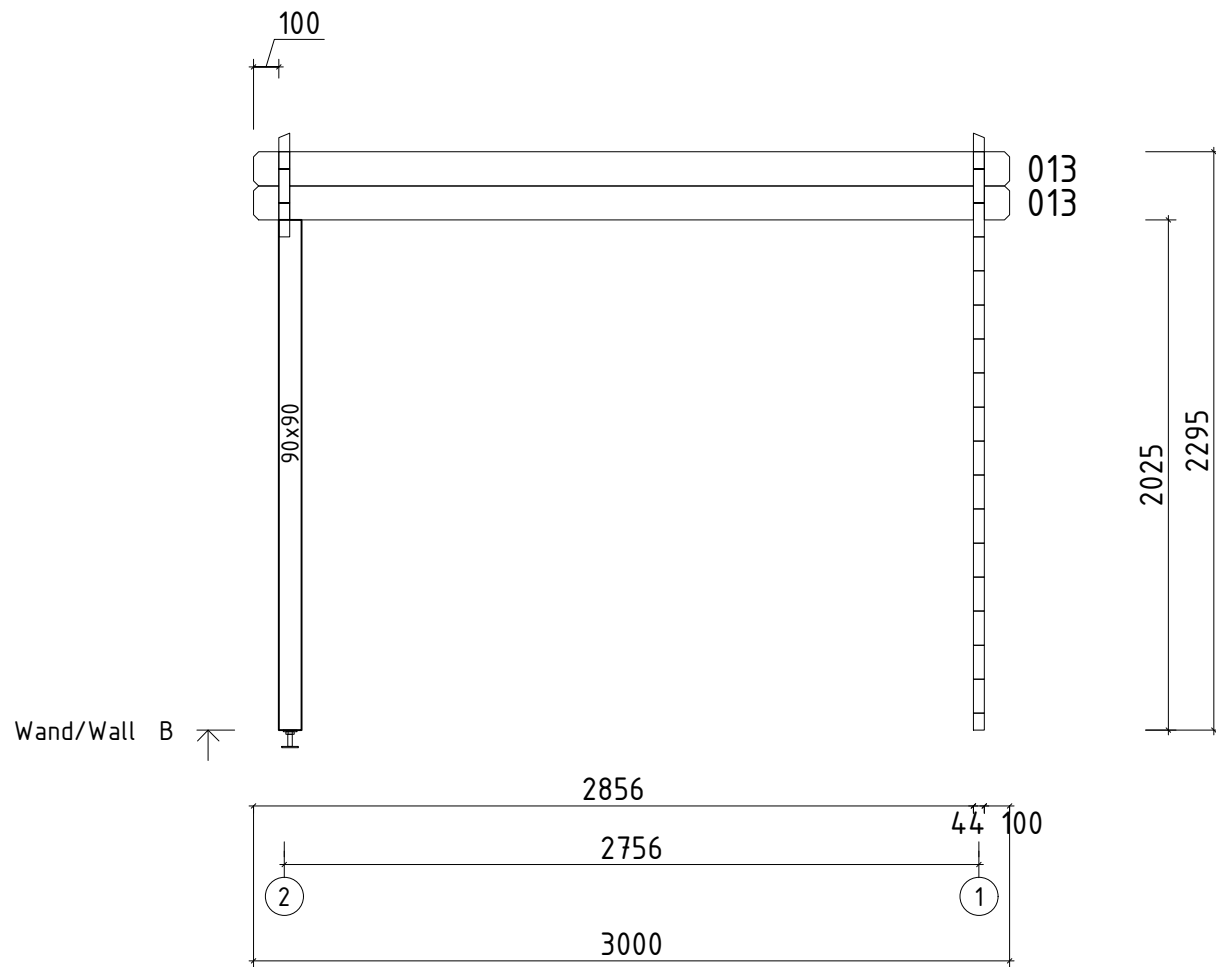

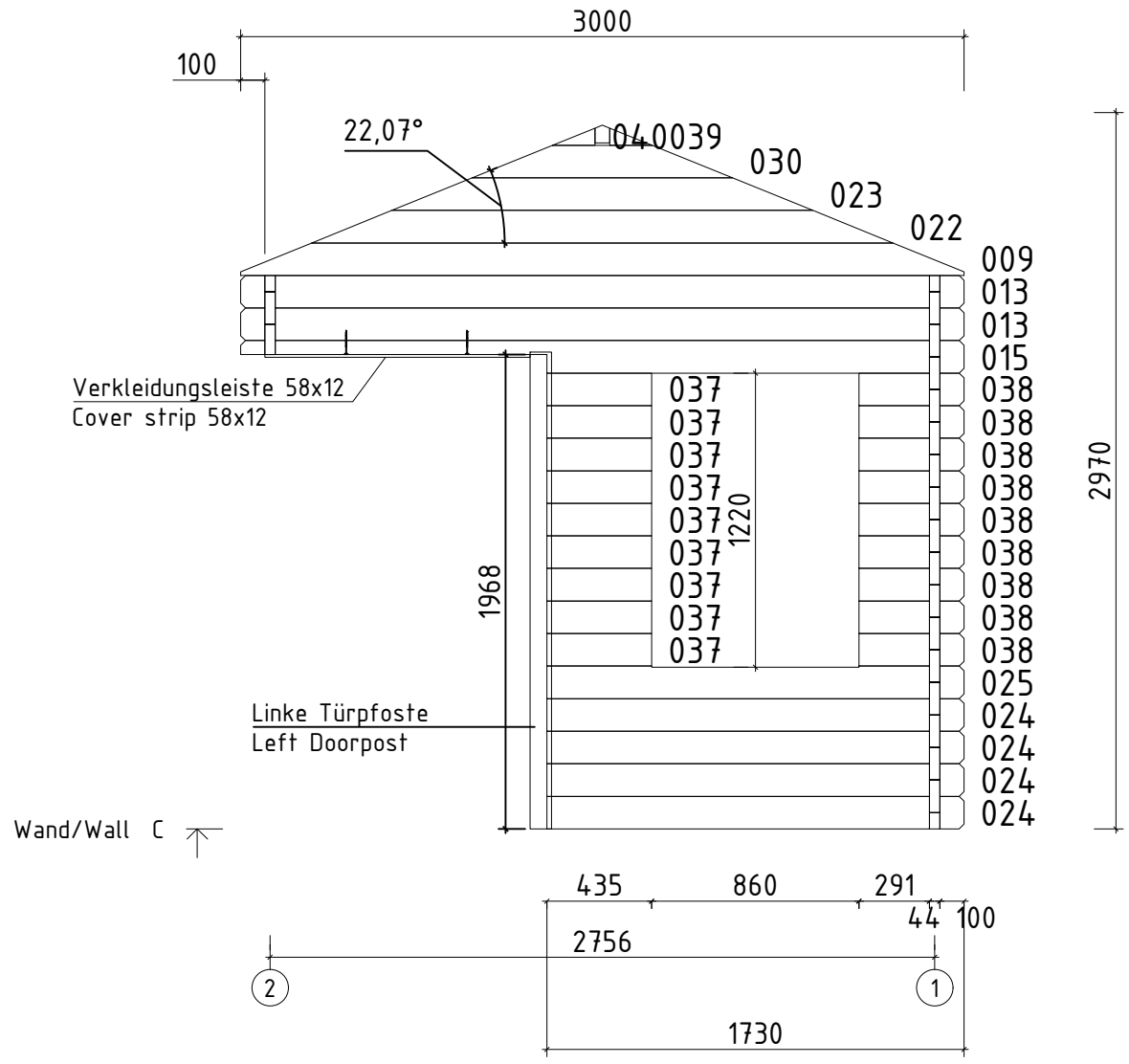

Name	Bertil 300x300+500/44		
Zeichnung/Drawing	WAND/WALL B		
Profil/Profile	4.4x13.5	Datum/Date	25.08.2020



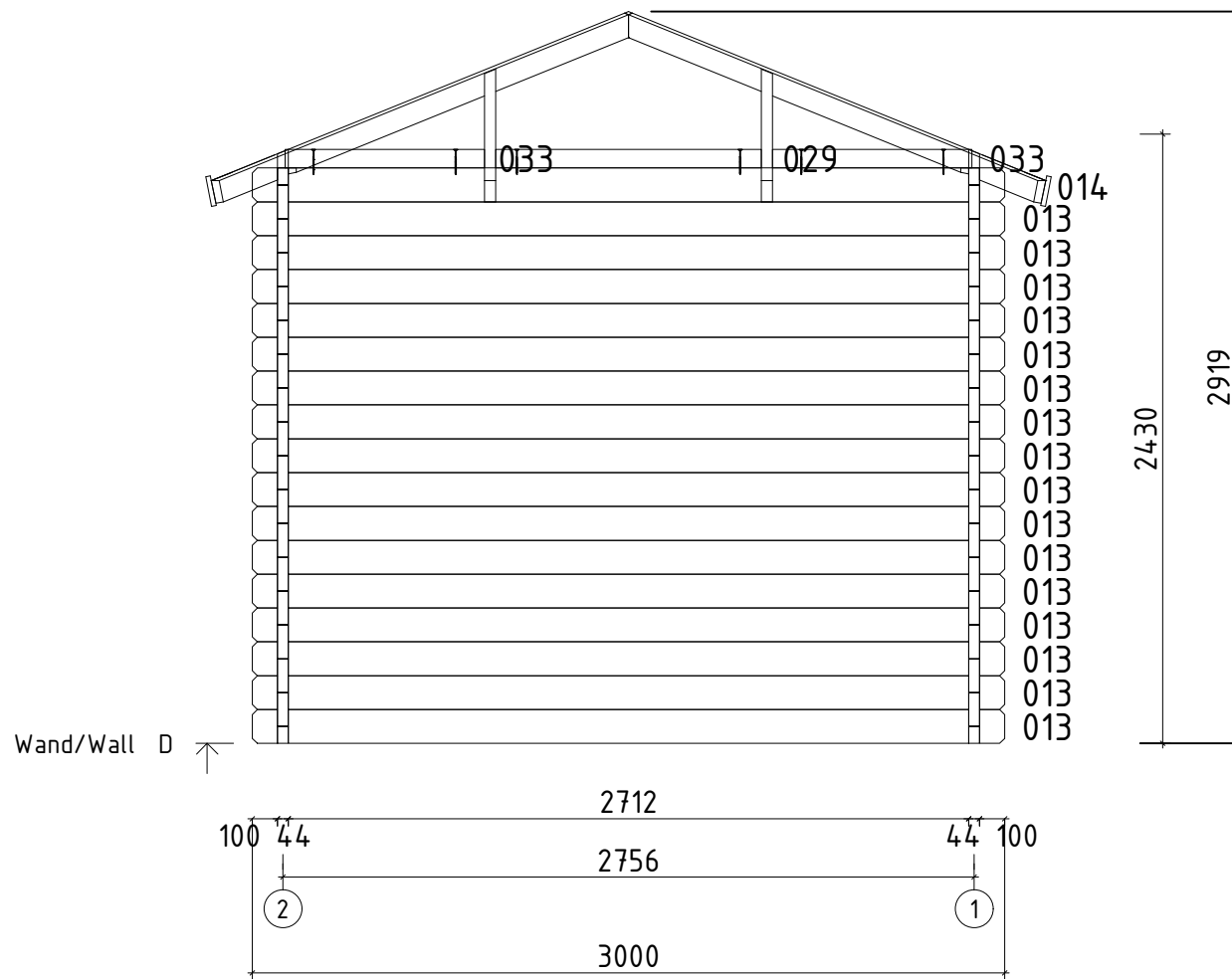



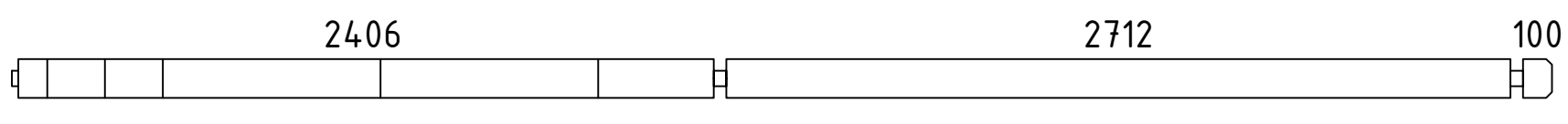
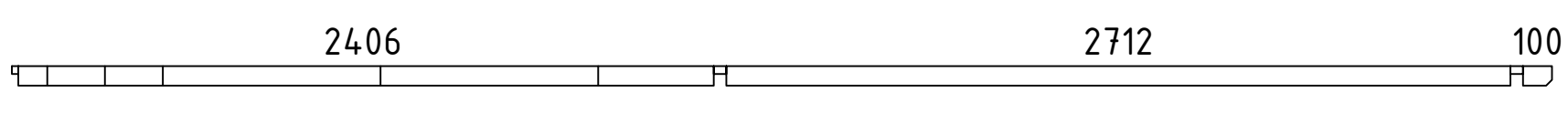
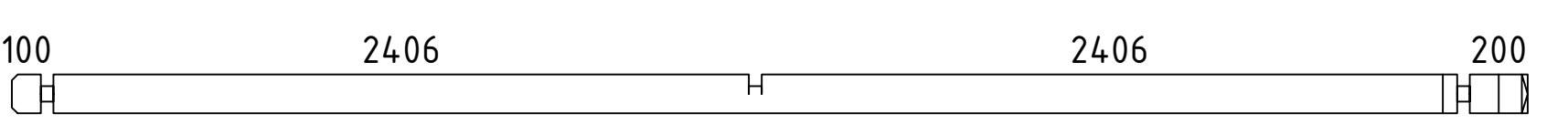
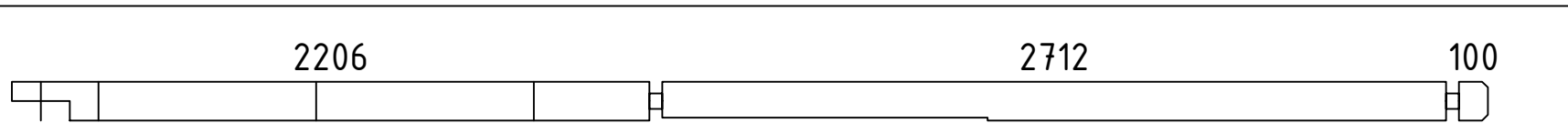
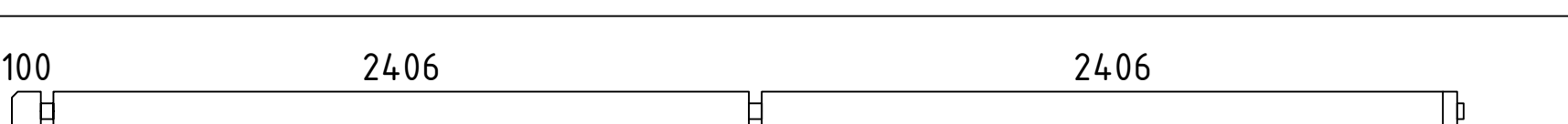
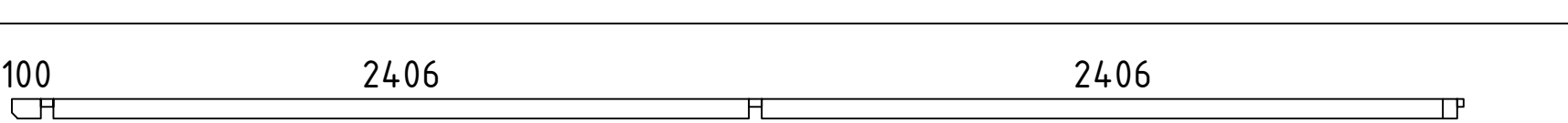
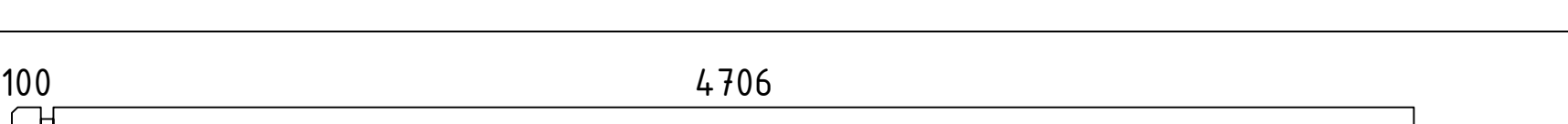
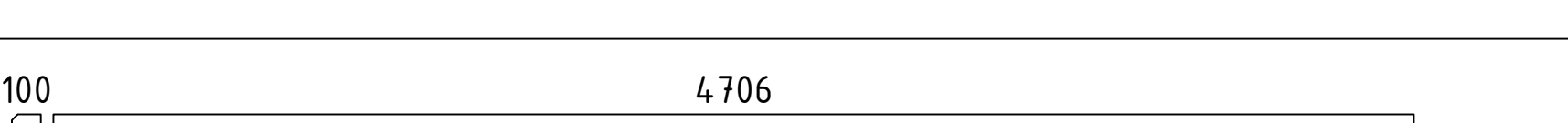
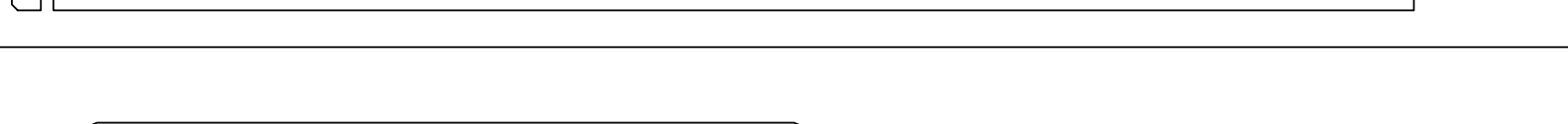
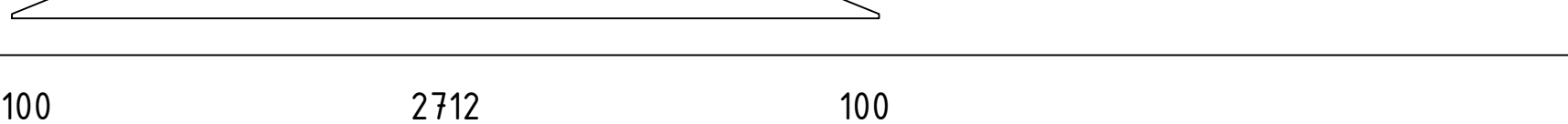
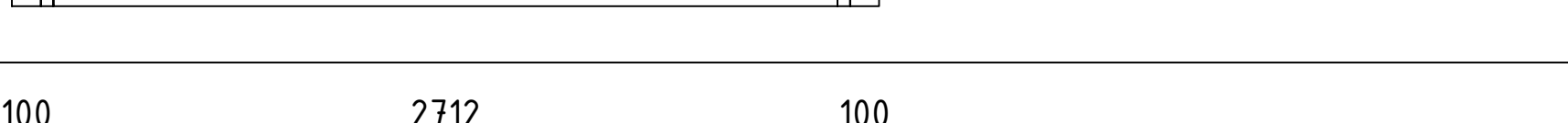
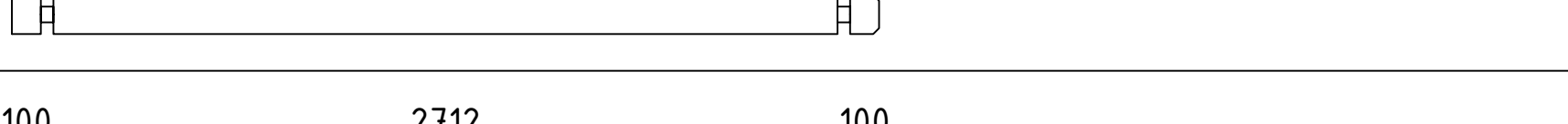
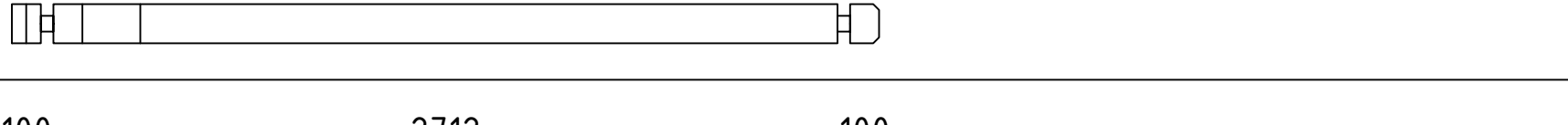
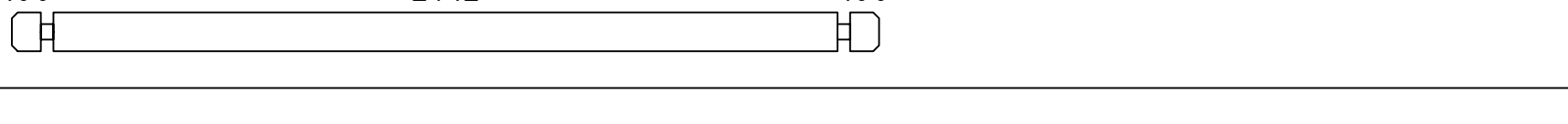
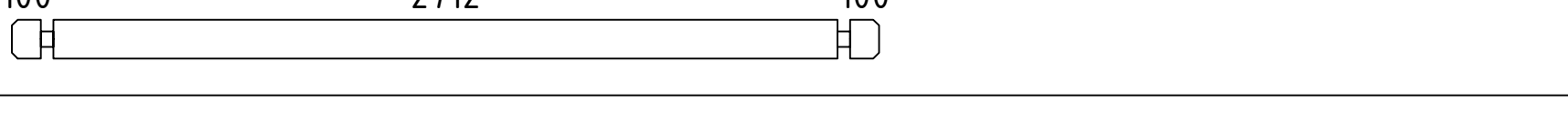
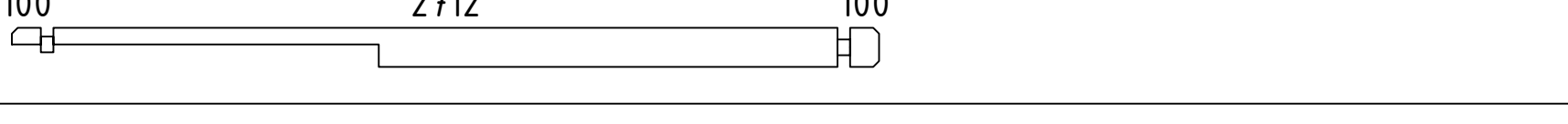
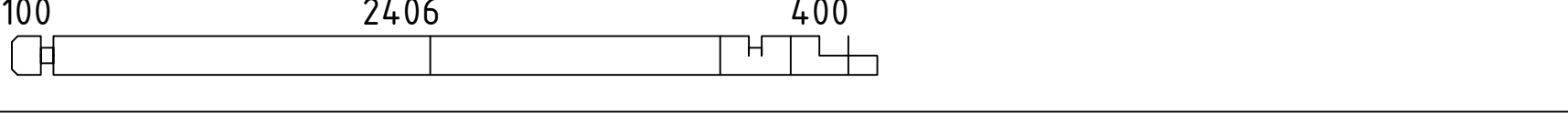
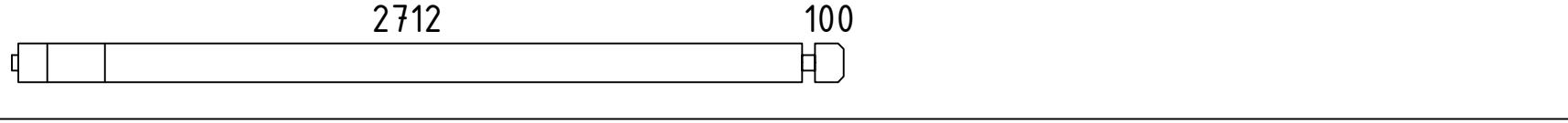
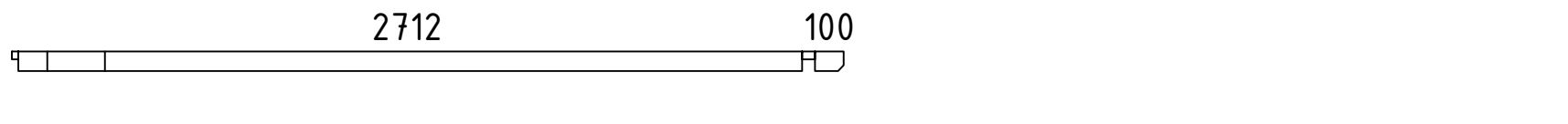
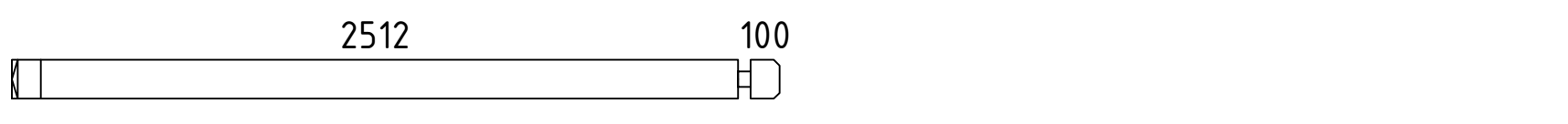
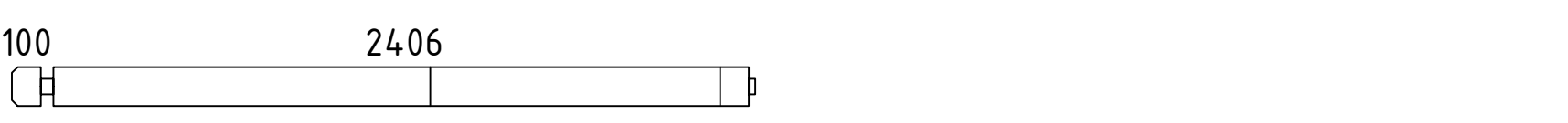
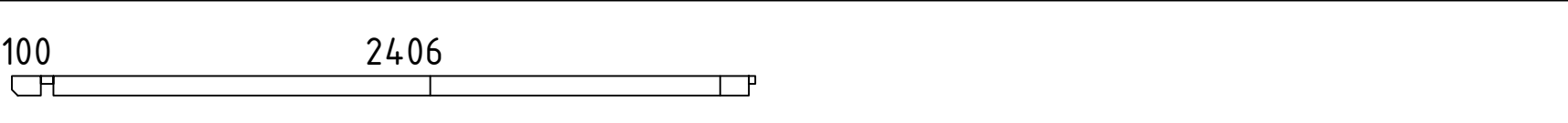
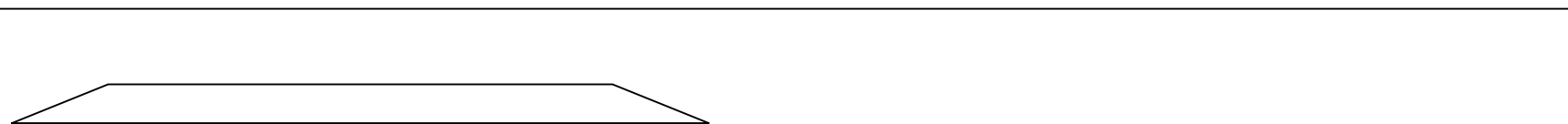



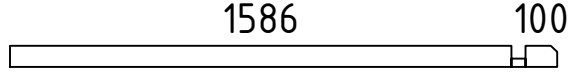
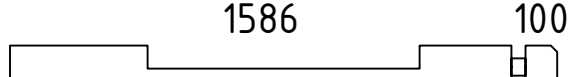
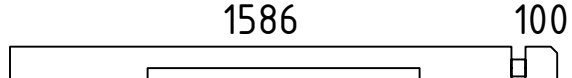
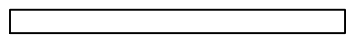
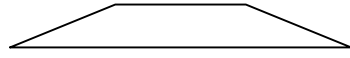
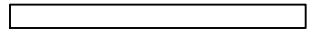
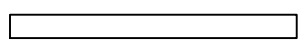
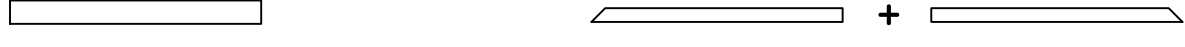
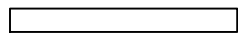
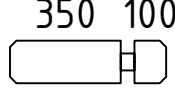
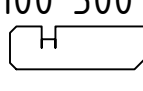
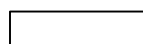
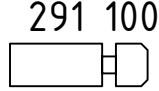

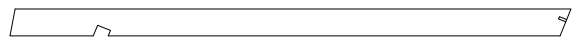
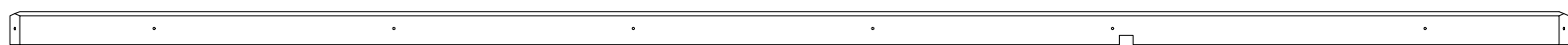
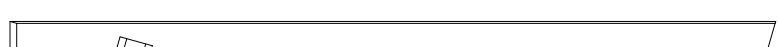
Name	Bertil 300x300+500/44		
Zeichnung/Drawing	WAND/WALL C		
Profil/Profile	4.4x13.5	Datum/Date	25.08.2020

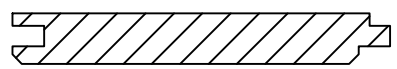
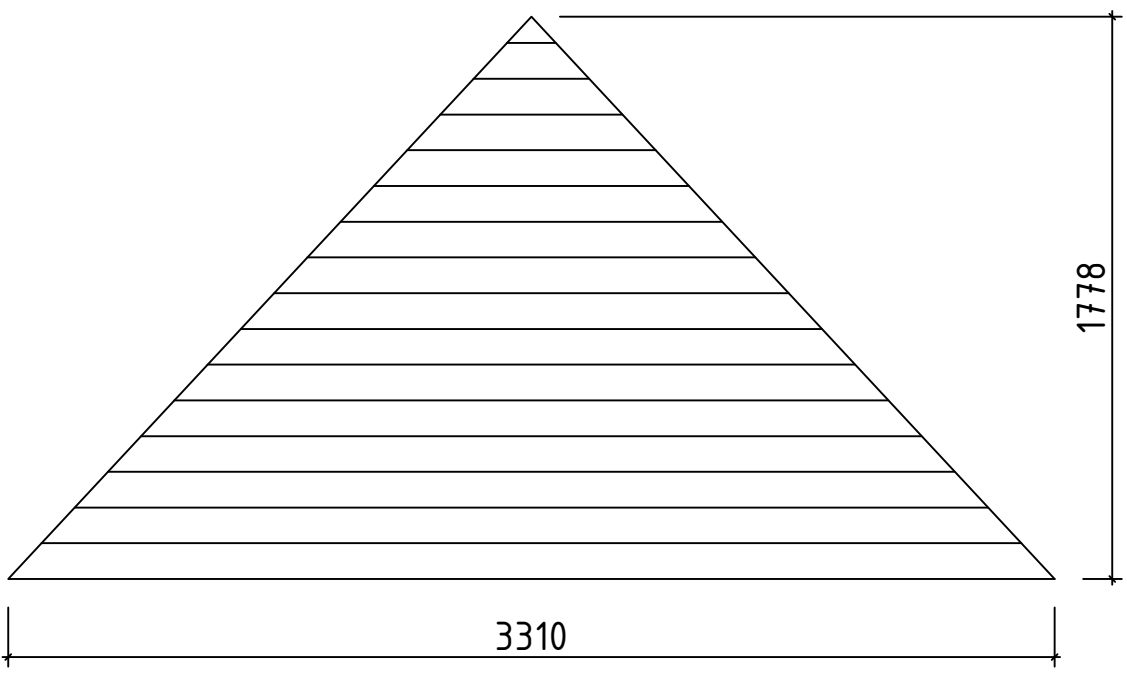

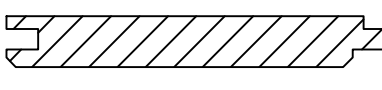
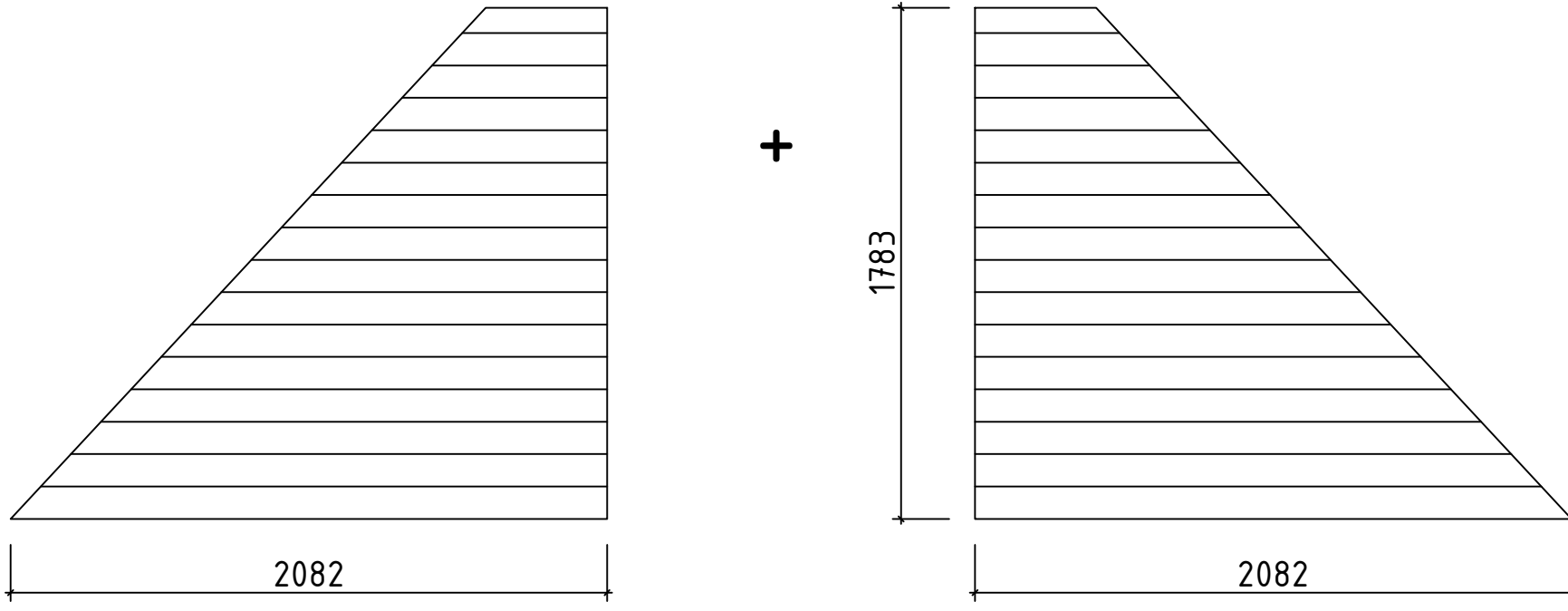
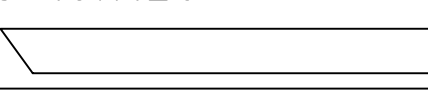
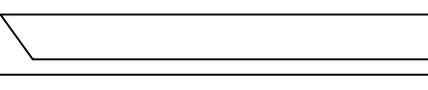
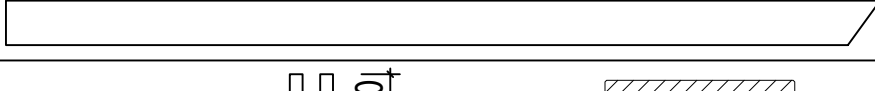
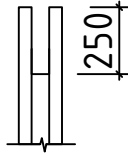
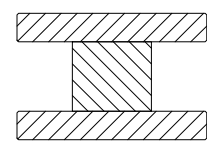
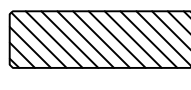
Name	Bertil 300x300+500/44		
Zeichnung/Drawing	WAND/WALL D		
Profil/Profile	4.4x13.5	Datum/Date	25.08.2020

Pos	Teileliste/Specification Bertil 300x300+500/44	Stck. Pcs.	Profil Profile (mm)	Länge Length (mm)
001		1	44x135	5328
002		1	44x68	5328
003		1	44x135	5244
004		1	44x135	5106
005		1	44x135	5022
006		1	44x68	5022
007		1	44x68	4850
008		14	44x135	4850
009		1	44x135	3000
010		1	44x68	3000
011		13	44x135	3000
012		1	44x135	3000
013		22	44x135	3000
014		2	44x135	3000
015		1	44x135	3000
016		1	44x135	2994
017		1	44x135	2878
018		1	44x68	2878
019		1	44x135	2656
020		1	44x135	2572
021		1	44x68	2572
022		1	44x135	2411
023		1	44x135	1745
024		8	44x135	1730
025		1	44x135	1730

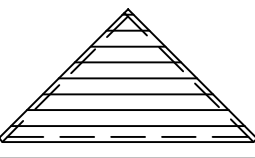
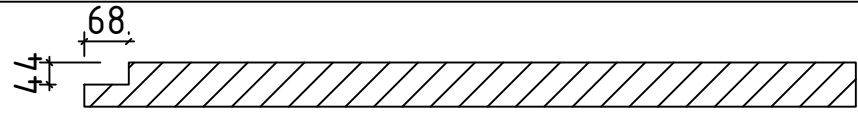
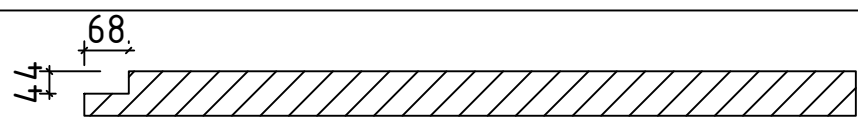
Pos	Teileliste/Specification Bertil 300x300+500/44		Stck. Pcs.	Profil Profile (mm)	Länge Length (mm)
026			1	44x68	1730
027			1	44x135	1730
028			1	44x135	1730
029			2	44x74	1060
030			1	44x135	1079
031			4	44x74	935
032			2	44x74	906
033			4+4	44x74	795
034			8	44x74	719
035			14	44x135	494
036			1	44x135	444
037			17	44x135	435
038			17	44x135	435
039			1	44x71	176
040			1	44x71	176
SPR1	SPARREN - RAFTERS 		12	44x85	1776
FPF1	FIRSTPFETTEN - RIDGE BEAMS 		1	62x105	4962
GSP1	GRATSPARREN - HIP RAFTERS 		4	44x94	2424
SFT1	SCHIFTER - JACK RAFTERS 		4+4	44x85	1205
	DACHBRETTER - ROOF BOARDS 		32+1	113x16	4045
	DACHBRETTER - ROOF BOARDS 		2	113x16	
Kood	Bertil 300x300+500/44	Materjal	File	Bertil 300x300+500-44.dwg	Leht 2/4

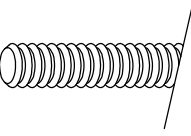
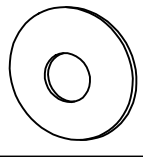
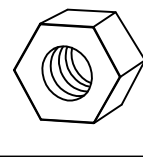
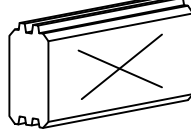
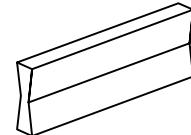
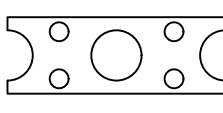
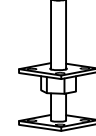
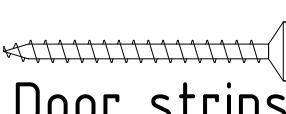
Pos	Teilleiste/Specification Bertil 300x300+500/44		Stck. Pcs.	Profil Profile (mm)	Länge Length (mm)
	DACHBRETTER - ROOF BOARDS  		2+2	113x16	
T02-1	TRAUFBRETTER - EAVES BOARDS 18x120 	✓	1+1	18x120	3690
T02-2	TRAUFBRETTER - EAVES BOARDS 18x120 	✓	1+1	18x120	4680
T02-3	TRAUFBRETTER - EAVES BOARDS 18x120 	✓	2	18x120	3420
A44-1	ADAPTER 44  	✓	1	80x120	2160
DzT 58-1	ECKTÜR- Deckbrett zum Tür - CORNER DOOR- cover strip for door 		1	18x58	1585
VK1-1	ECKTÜR- Verkleidungsleisten für Vordachelement - CORNER DOOR- trim strips for canopy element 	✓	2	58x12	1100
P9L2-1	ECKTÜR- linke Türpfoste - CORNER DOOR- left hand doorpost 		1	90x90	1980
P9R2-1	ECKTÜR- rechte Türpfoste - CORNER DOOR- right hand doorpost 		1	90x90	1980
VE1	ECKTÜR- Vordachelement - CORNER DOOR- canopy element 		1		
TP90-1	STÜTZPFOSTE - SUPPORT POST 90x90 	✓	1	90x90	2190
TP90-2	STÜTZPFOSTE - SUPPORT POST 90x90 	✓	1	90x90	2325
ML1	Metallstange - Metal bar 		3	D10	430
KL1	Gewindestange - Threaded Rod M8 		7		340
	Mutter - nut M8 U-Scheibe - washer Ø25  		14		
SH	SCHLAGHÖLZER - MOUNTING PIECES 		3		
HK2	HOLZ-KLOTZEN für verbinden der Wandbohlen - Wooden wedge for connecting the wall parts (122mm) 		1		
VS	Verbindungsstreifen für verbinden der Wandbohlen - Connecting strip for connecting the wall parts 		4		
VP2	Verstellbare Pfostenstütze - Adjustable post support M16 		2		
SR37	Schrauben - Screws 3.5x45  Verbindungsstreifen - Connecting strip Fenster- und Türleisten - Window and Door strips		88		
Kood	Bertil 300x300+500/44	Materjal	File	Bertil 300x300+500-44.dwg	Leht 3/4

Aken	Q4-Q6	-	paigaldusjuhhis
Window	Q4-Q6	-	assembly instructions
Fenster	Q4-Q6	-	Montageanleitung

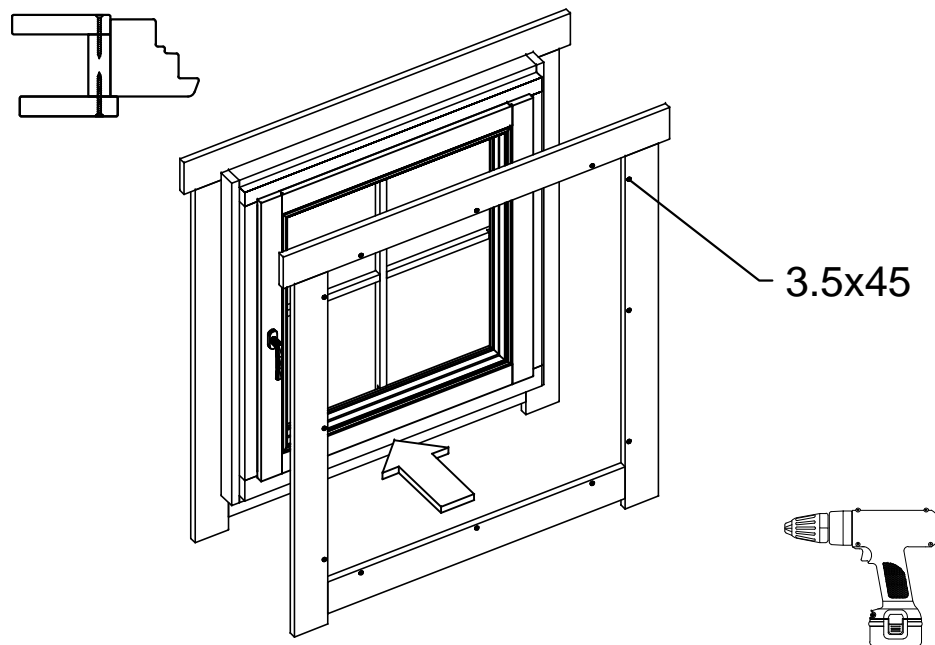
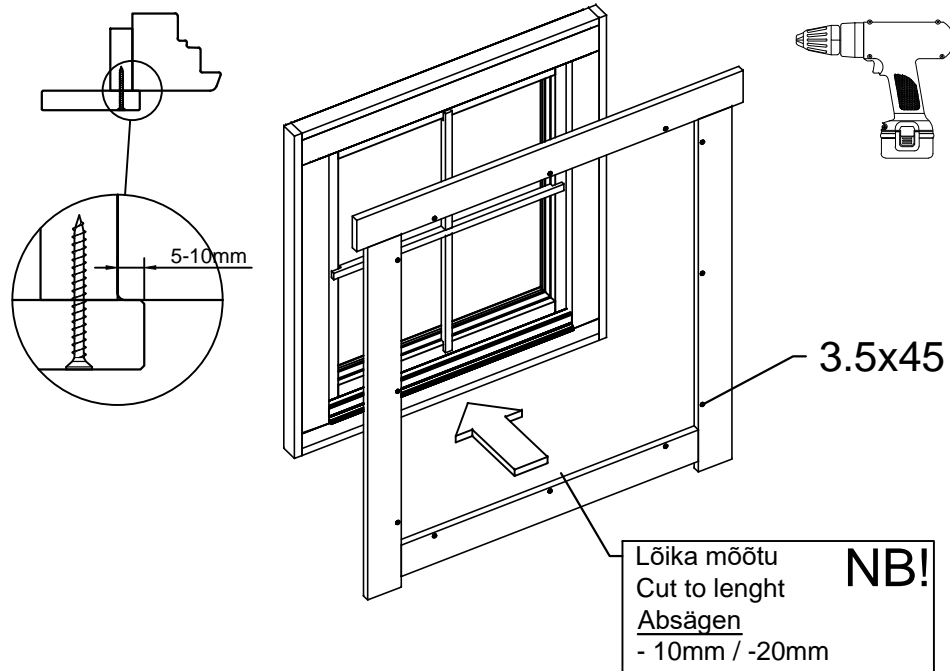
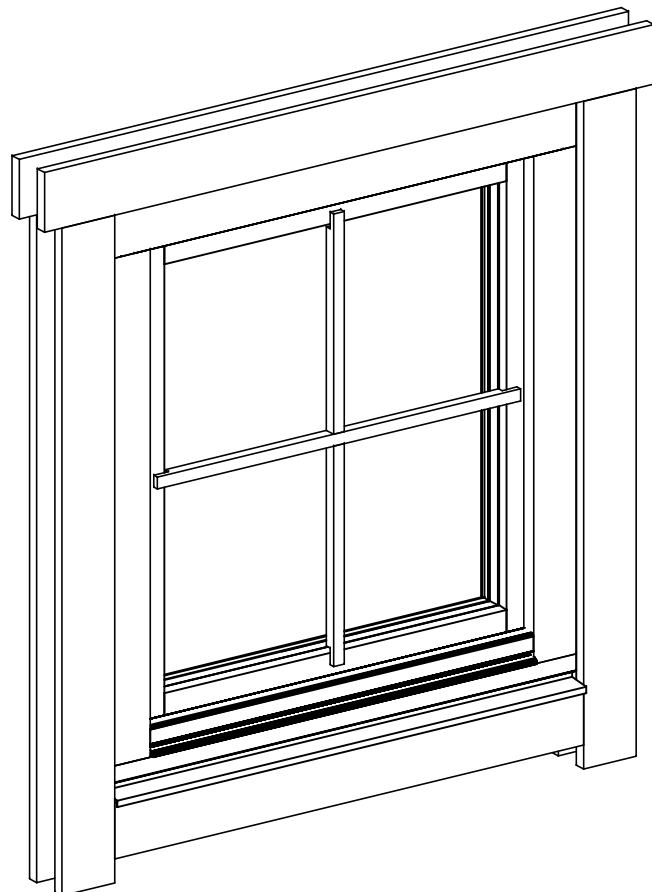

Ukse montaa 0 / Tür montage / Door assembly
(GH+ / SH)

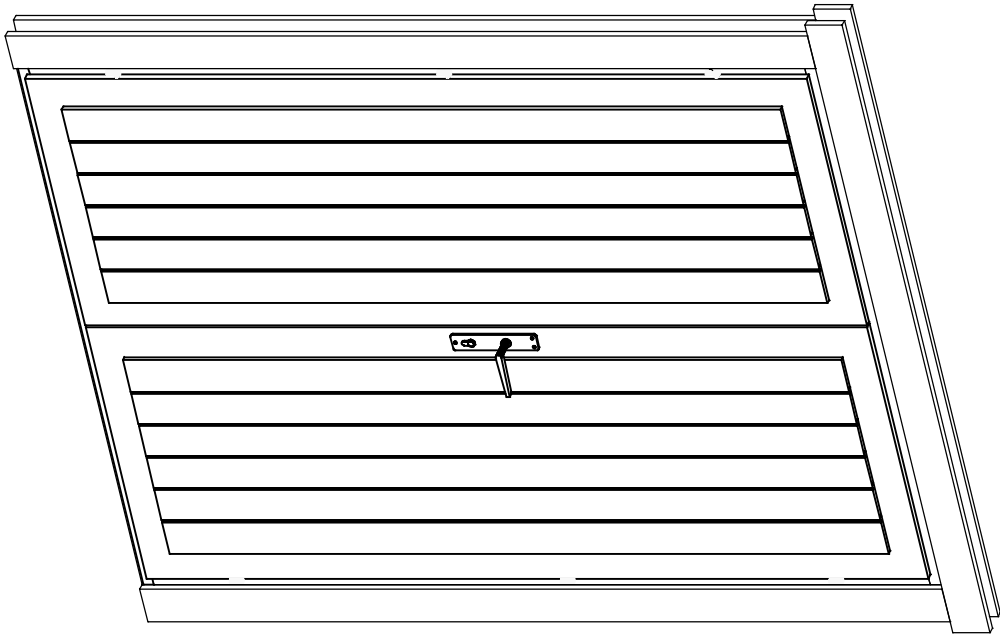

4.5x90

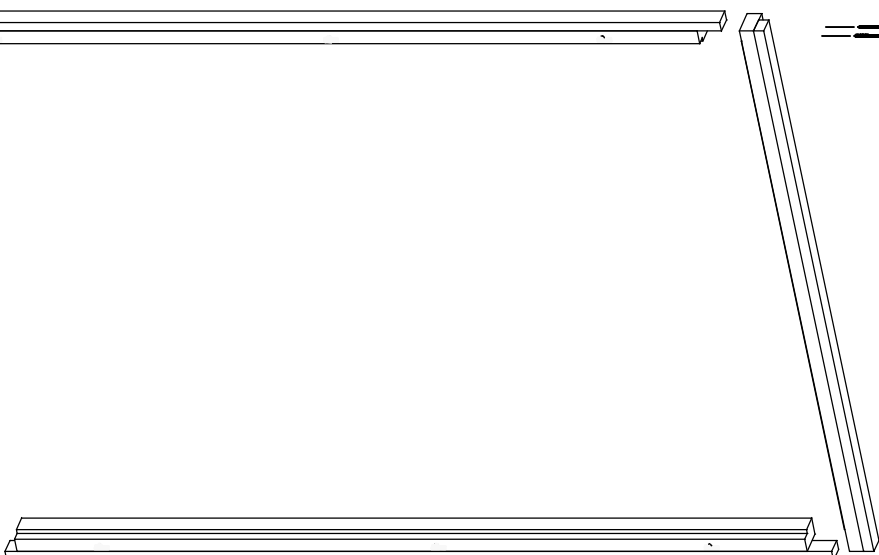

4.5x90



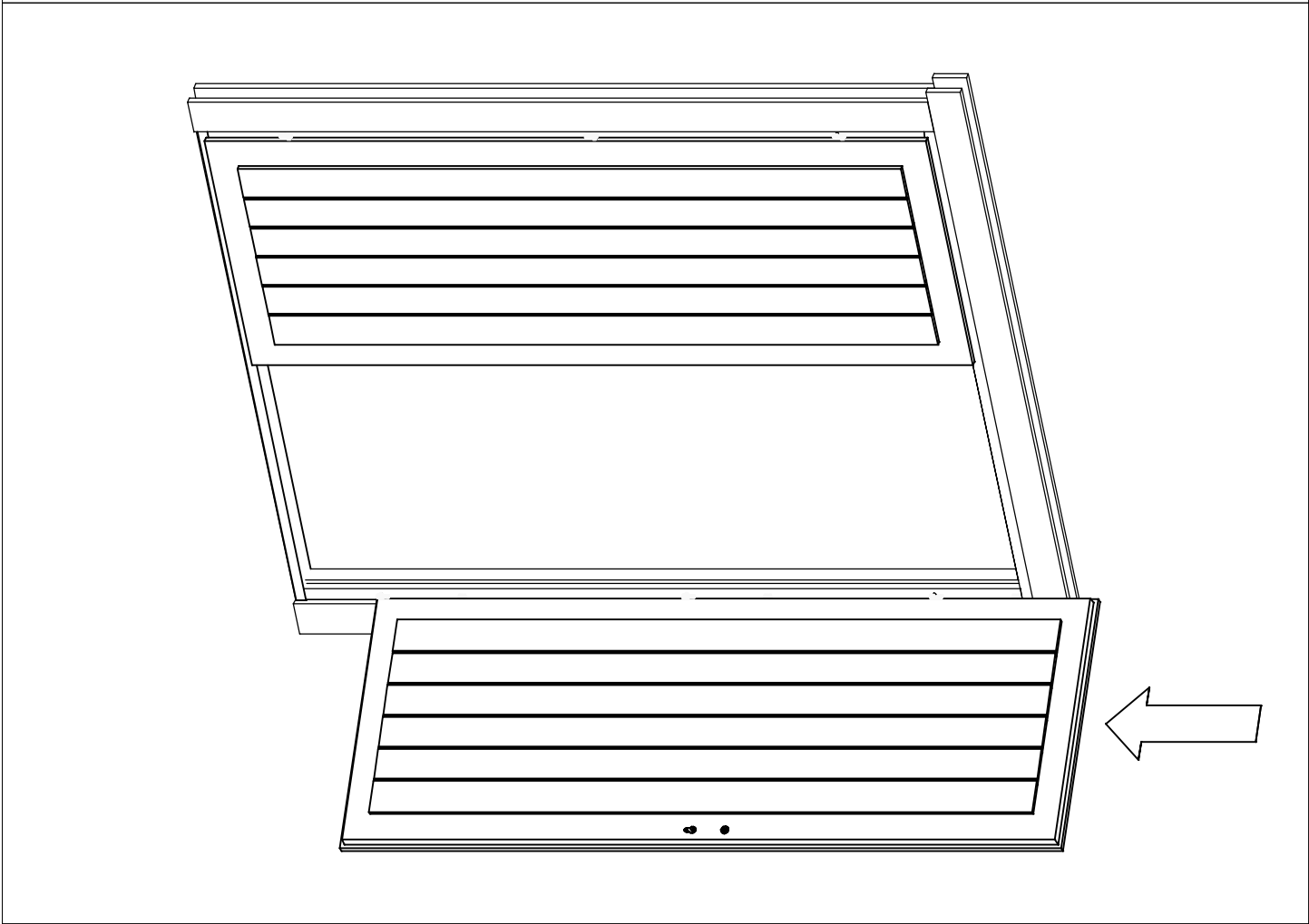
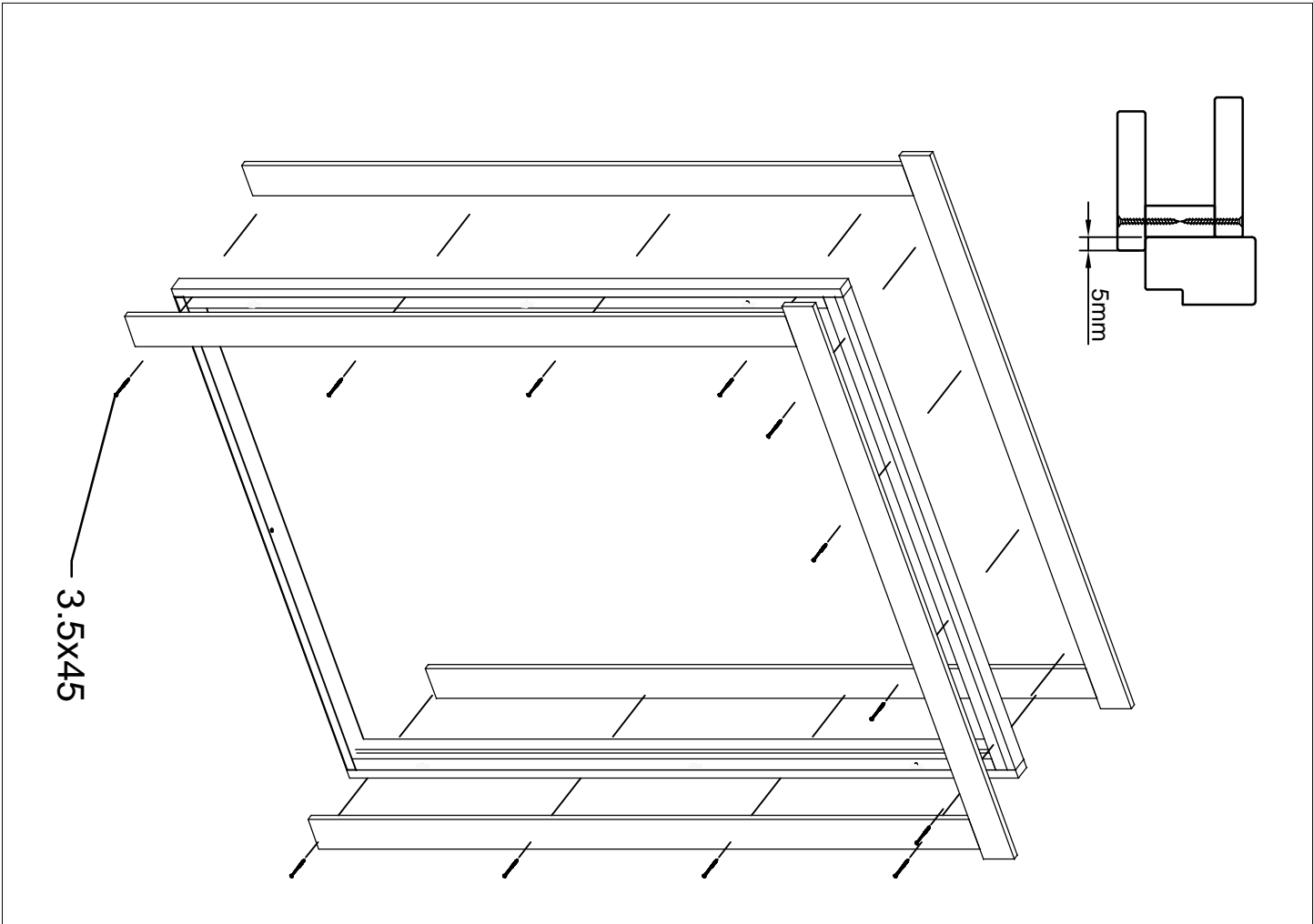

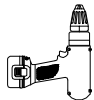
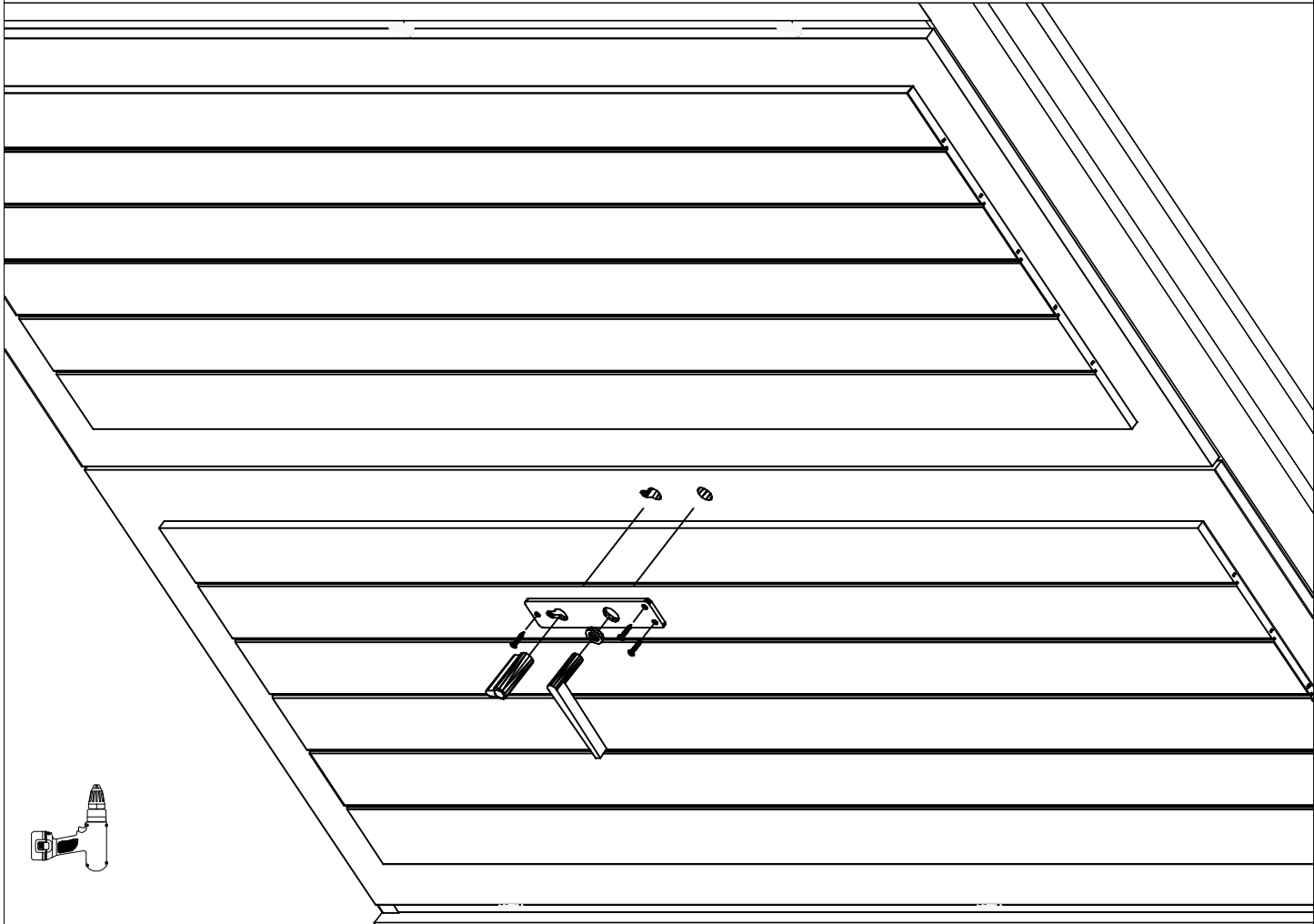
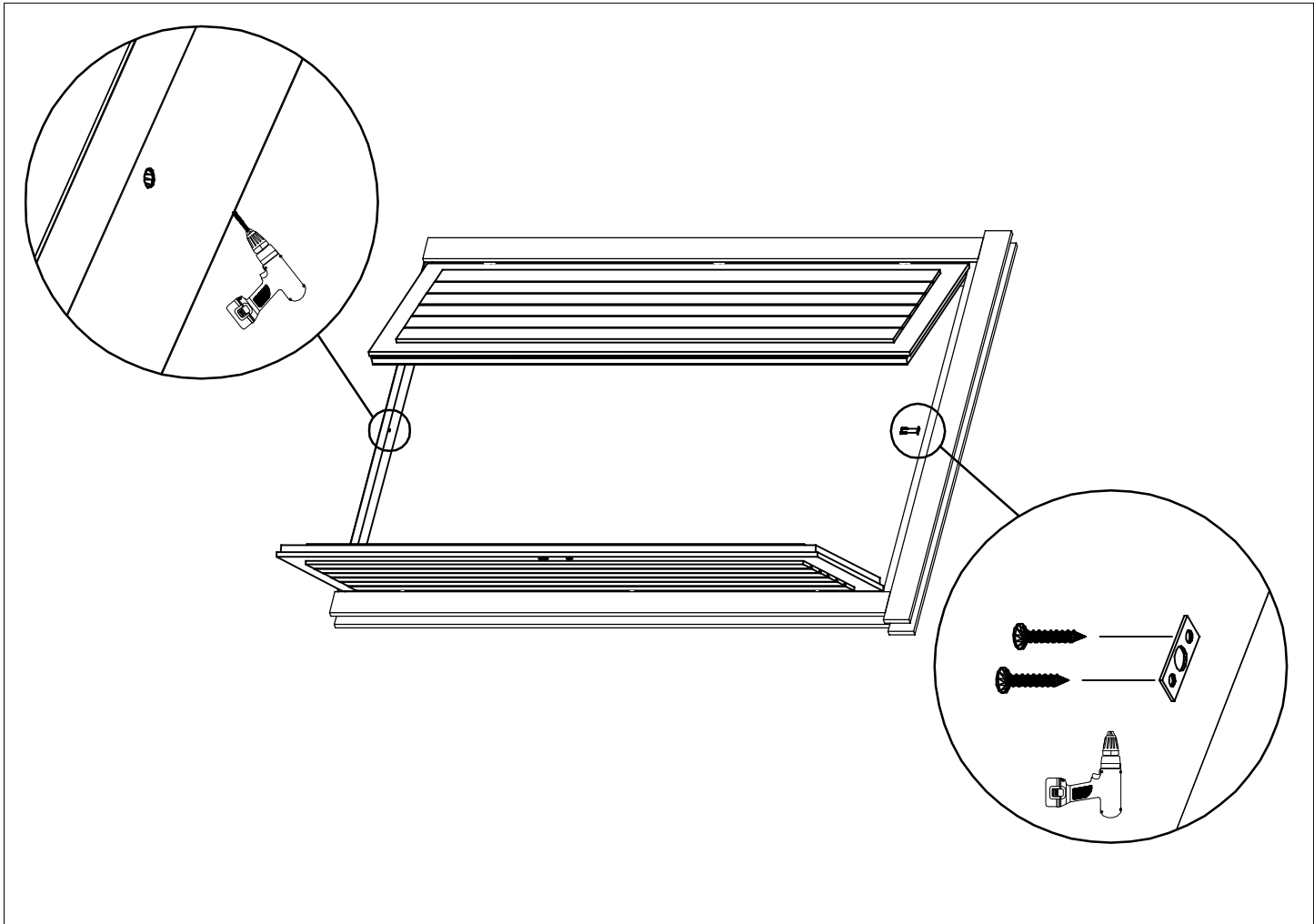

Step 1: Dachelement an den Wänden verschrauben.
Step 1: Screw canopy element to the wall.

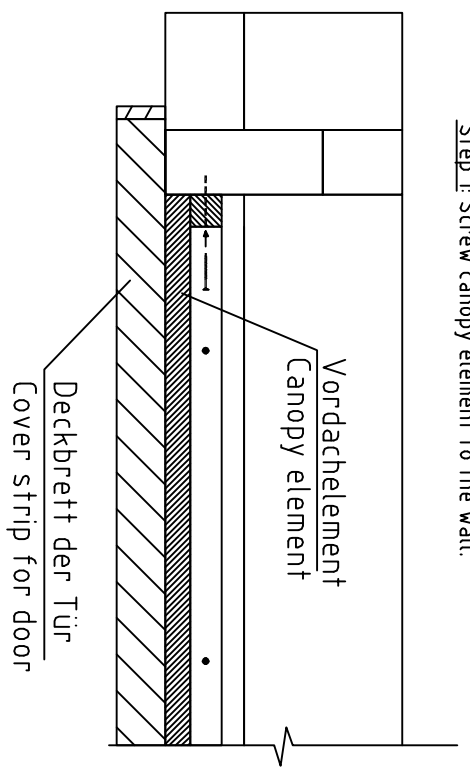

Step 2: Das Deckbrett muss von oben (durch das VD-Element) an das Dachelement verschraubt werden.
Step 2: Fasten cover strip to the canopy element.

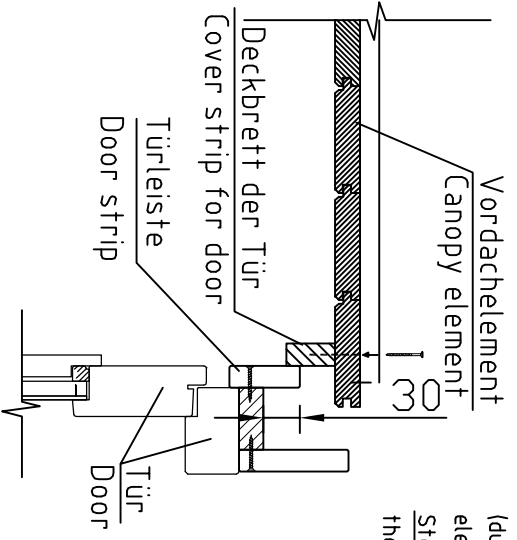

Step 3: Die Verkleidungsleisten in die richtige Länge schneiden und unter das VD-Element befestigen.
Step 3: Cut trim strips to size and fasten under the canopy element.

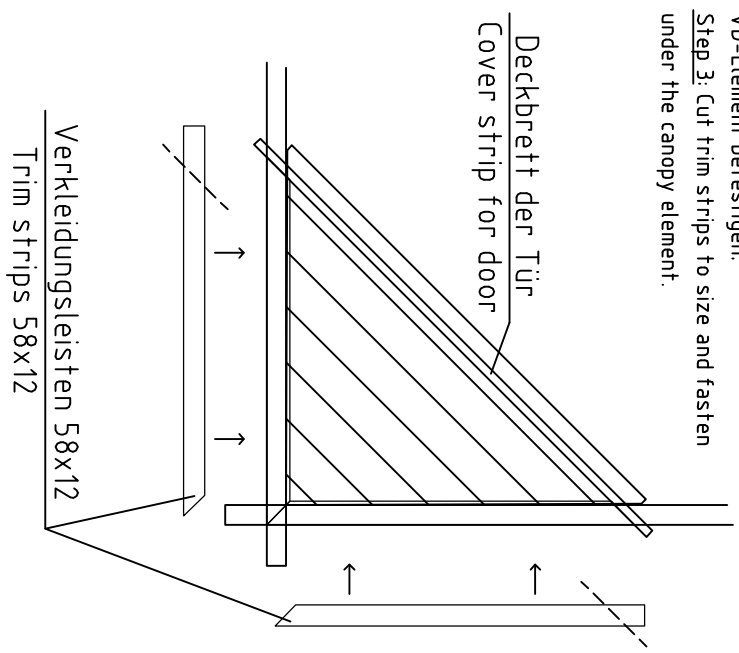

Vordachelement/Canopy element

Schnitt/Section

Cutting support post / Schneiden der Stützpfosten



- * Adjustment space for post support should be at least 50mm.

* Einstellraum für die Pfostenstütze muss mindestens 50mm sein.

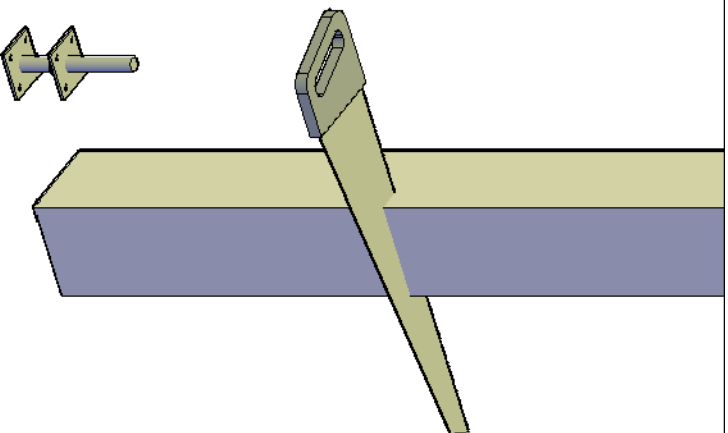

- * Support post has extra length for various conditions. Must be sawn to suitable length on spot considering local conditions.

* Stützpfosten hat extra Länge für verschiedene Bedingungen. Muss vor Ort unter Berücksichtigung der örtlichen Gegebenheiten zu einer geeigneten Länge gesägt werden.

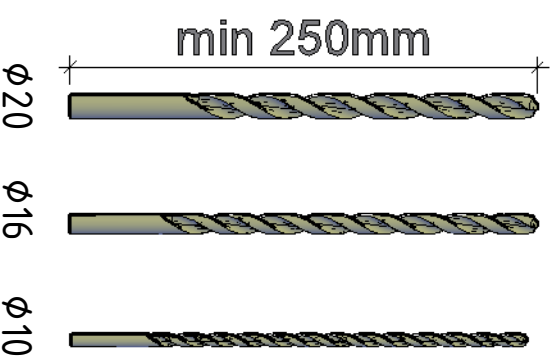
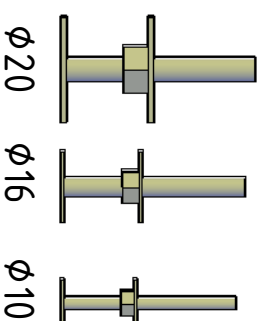

- * In some cases you need to drill a new hole for a post support. Find a matching drill bit.

* In einigen Fällen müssen Sie ein neues Loch für die Pfostenstütze bohren. Finden Sie hier den passenden Bohrer.

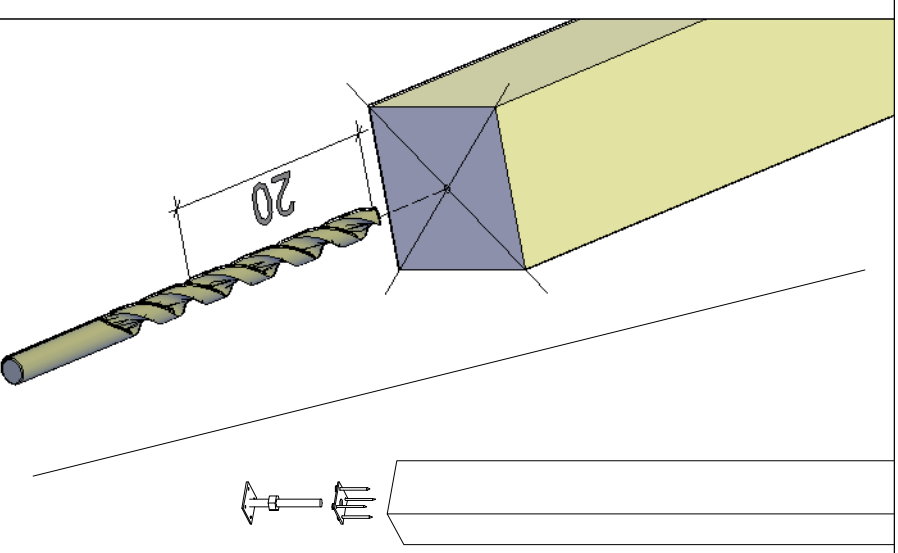

- * Mark the center of the post and drill a new 20cm deep hole.

Continue building.
* Markieren Sie die Mitte des Pfostens und bohren Sie ein neues 20cm tiefes Loch. Danach mit Aufbau weiter machen.