























Pos	BOLTON 4,4 x 3,4 + 2,0 58x135	Profile	Length	St.
D2 C2		58x135 	5870	2
E6 B2			4400	16
D3 C3			3400	14
C4			3400	1
A3			4400	1
D1 C1		58x135	5630	8
C6			637	14
E2			1050	4
E5			1050	2
A2			560	28
E4			400	4
C5 D4 E3			258	44
B1 A1		58 x 67 	4400	2
E1			1050	2
A4 B4 E7		58x540	4400	3
23	ROOFING BOARDS	19 x 85 	2380	140
24	WINDOW	2126 x 966		1
25	Block of doors	3280 x 1938		1
27	Roof of cover fixture	20x120 or 20x145	2430	4
28	Roof of cover fixture	20x95 	2450	4
35	Beam	40x40	2935	4
36	ROOF JOIST	58x145	5870	4
36\1	RIDGE BEAM	5870	5870	1
37	Amrest	28x95 	1972	2
			822	2
			675	2
38	Diamond			2
E8	Beam	40x40	2025	2



**BOLTON**

**4,4 x 3,4 + 2,0 58\135 mm**

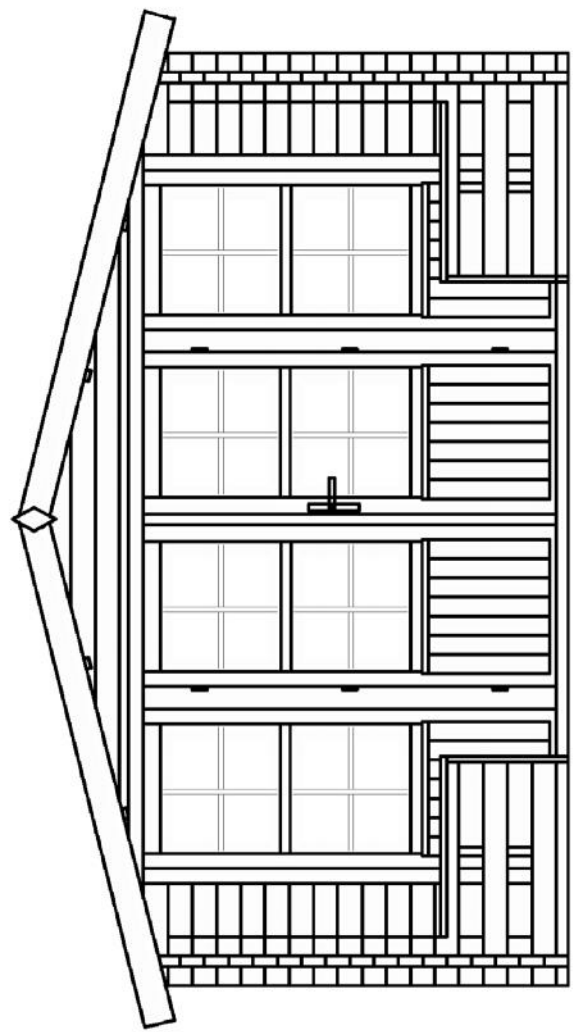
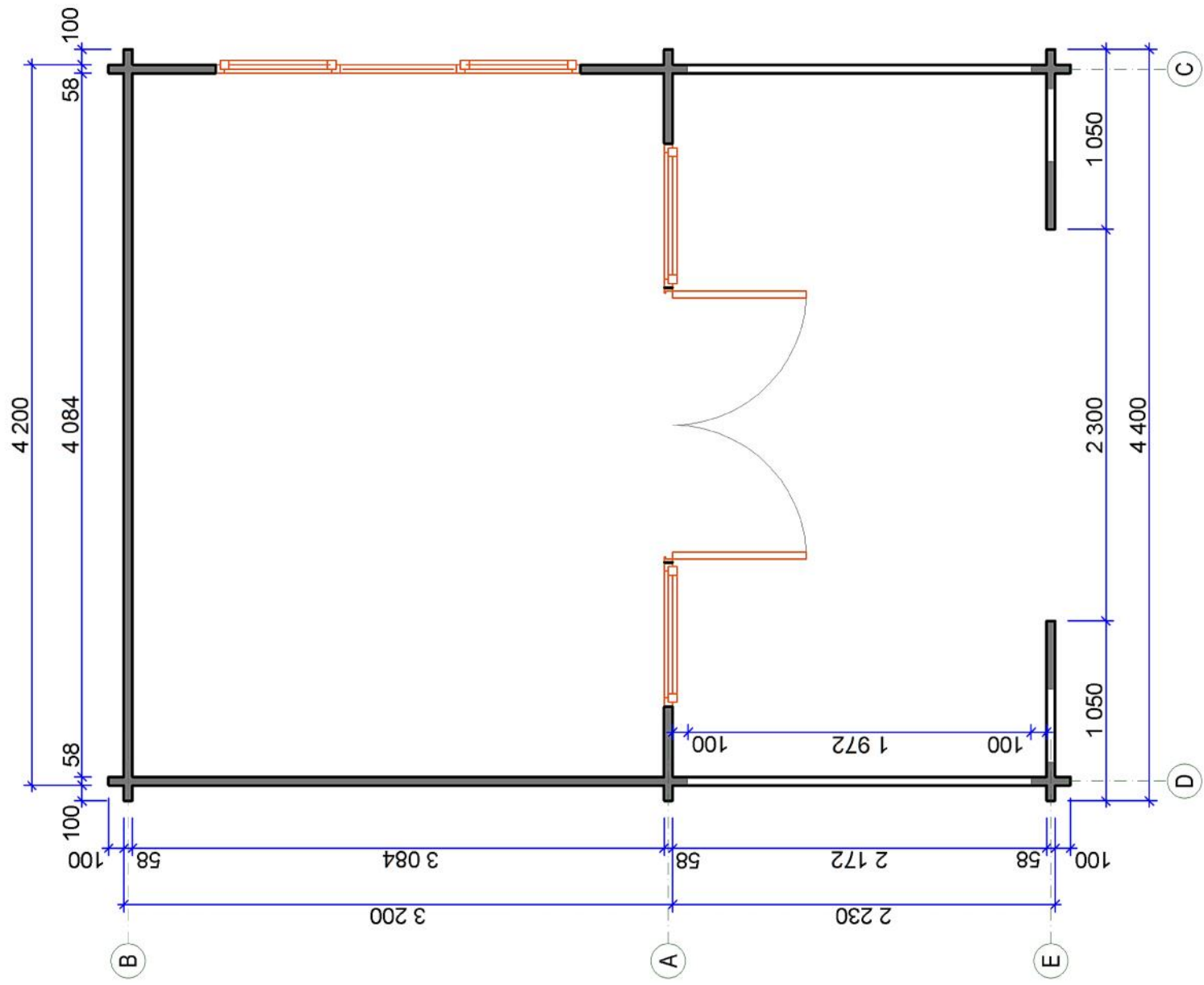
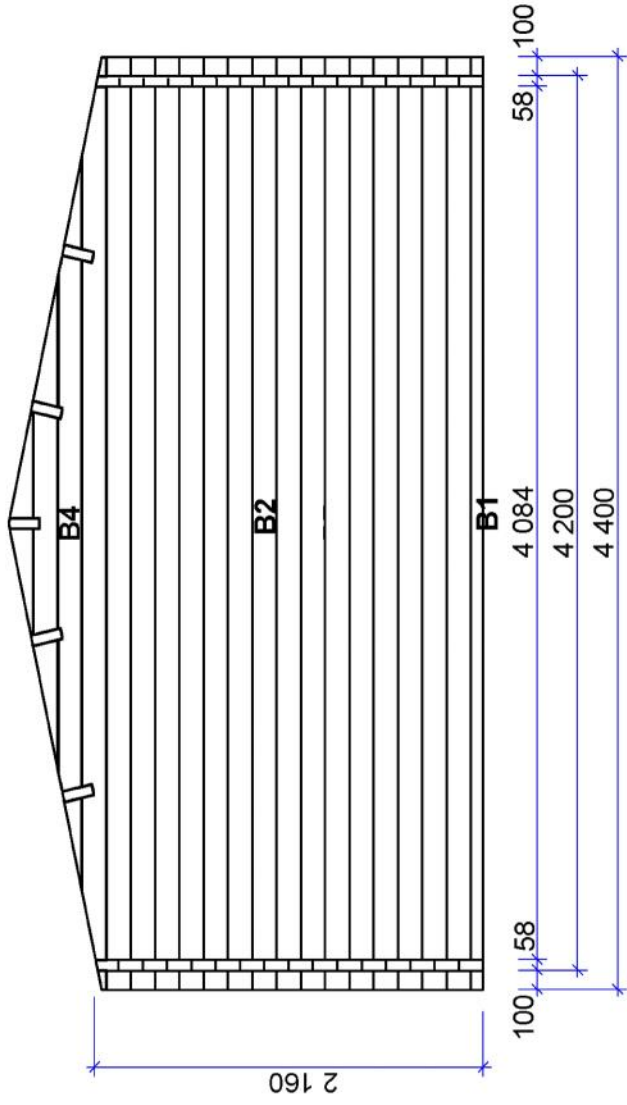

**Wall B**

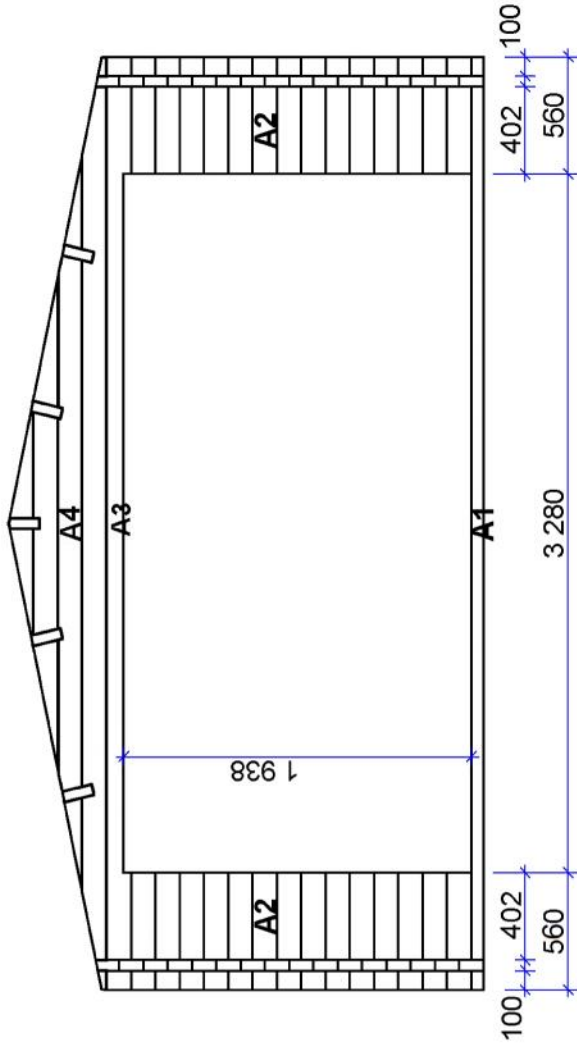

**Wall A**

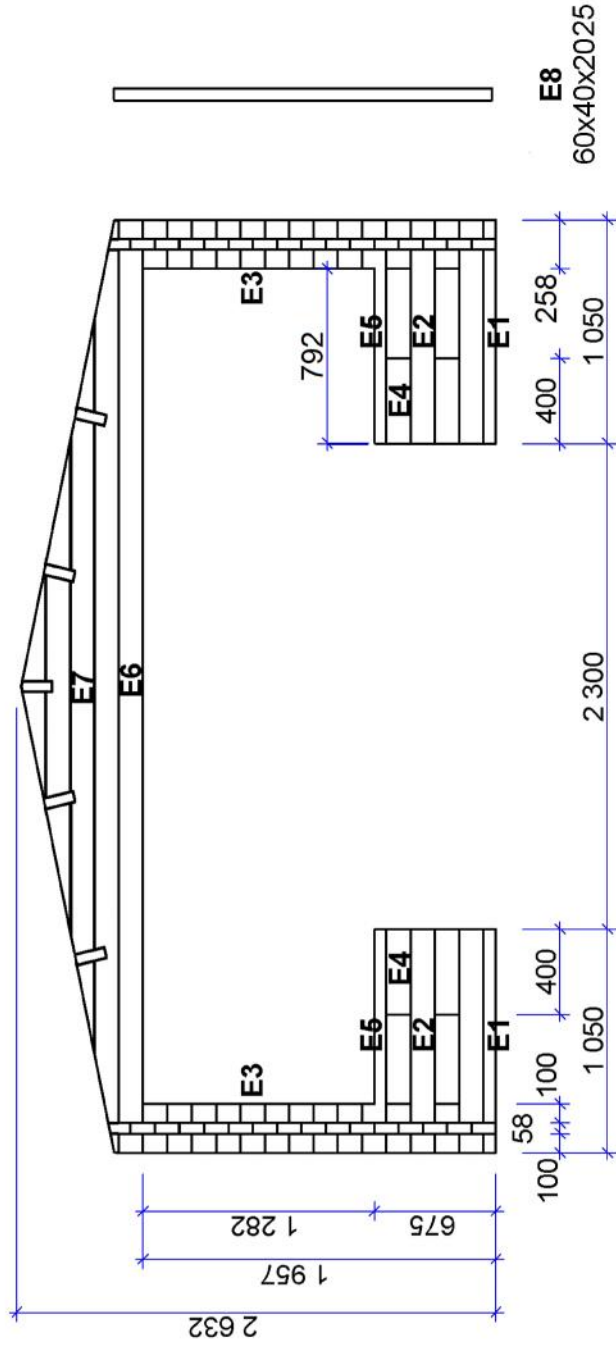

**Wall E**

### Wall C

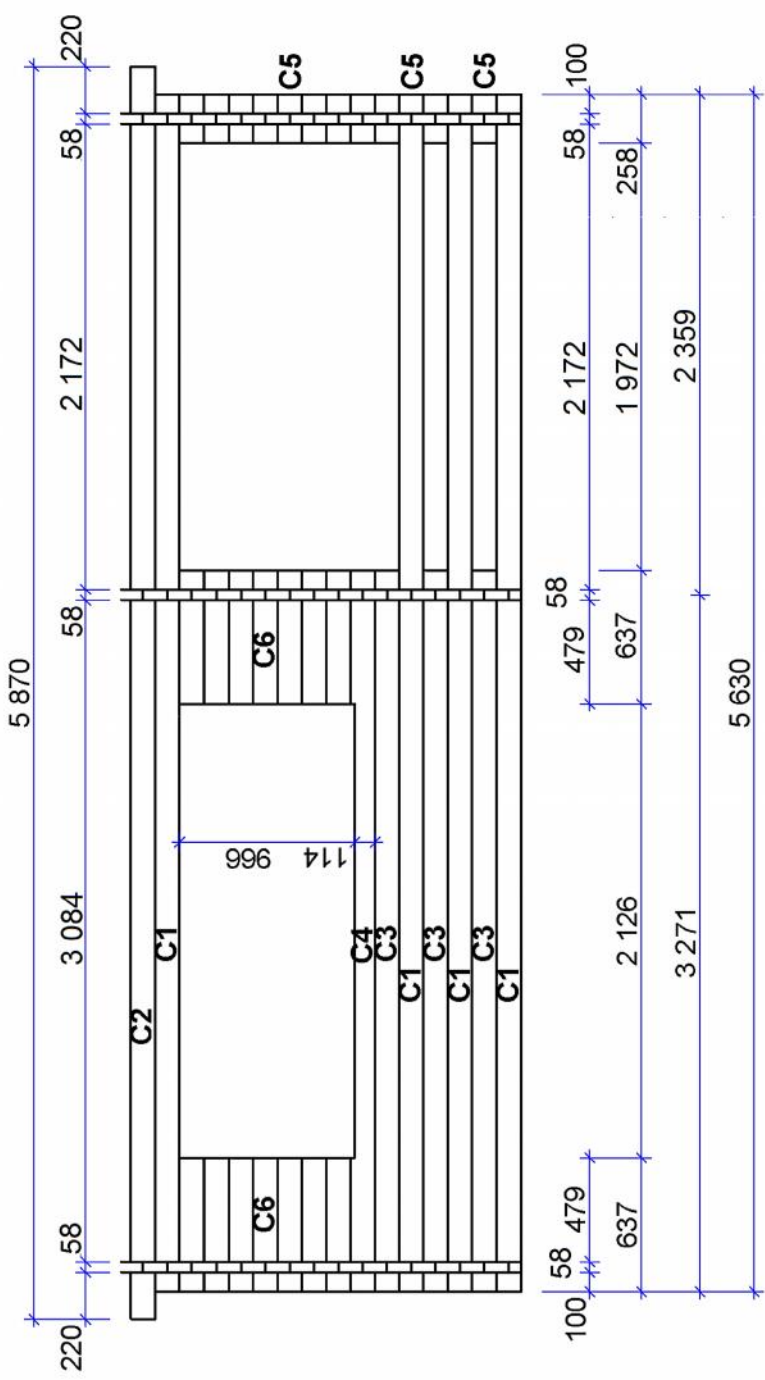

### Wall D

