

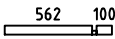

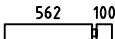

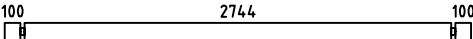

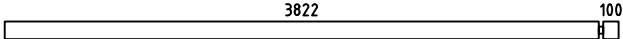
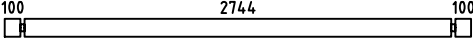
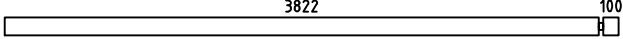
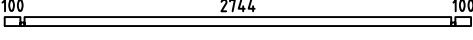
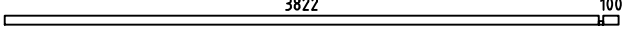

Charlotta28

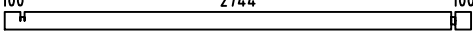
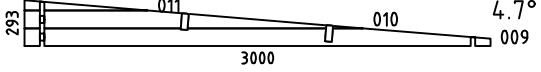
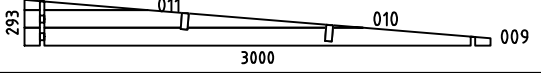
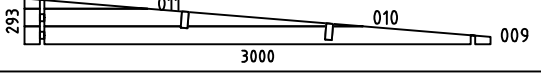
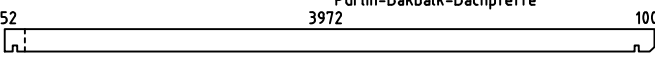
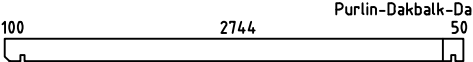
Pos	Specification-Spezifikation-Specificatie	St.	Profile (mm)	Length (mm)
001		2	28x57	690
002		33	28x114	690
003		48	28x114	3000
004		16	28x114	3950
005		2	28x114	3000
006		2	28x114	3950
007		1	28x57	3000
008		1	28x57	3950
012		15	28x114	315
013		1	28x114	3000
WA-1		1		
WB-1		1		
WC-1		1		
PR2		2	44x14.4	4180
PR1		2	44x14.4	2950
DP-1	Roof board-Dachbrett-Dakplank 	80	88x18	3250
	-POST 85x85 	1		2005
PS1	Diagonal for POST 44x85 	1		450
PS2	Diagonal for POST 44x85 	1		500
L-1	Eave Board-Traufenblende-Afdeklank 	2	18x120	3290
L-2	Eave Slat-Traufenleiste-Afdekljst 	2	40x18	3290
L-3	Eave Slat-Traufenleiste-Afdekljst 	4	40x18	3518
L-4	Facia Board-Giebelblende-Gevelplank 	4	18x120	3518
H1	H-Profile 	1		228
H2	H-Profile 	1		1835
Kood	Materjal	File	Charlotta28.dwg	Leht 1/2

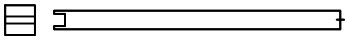
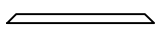
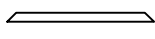
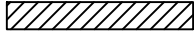
H = 1.500 m
 TOTAL: 7.53 m²

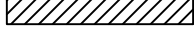

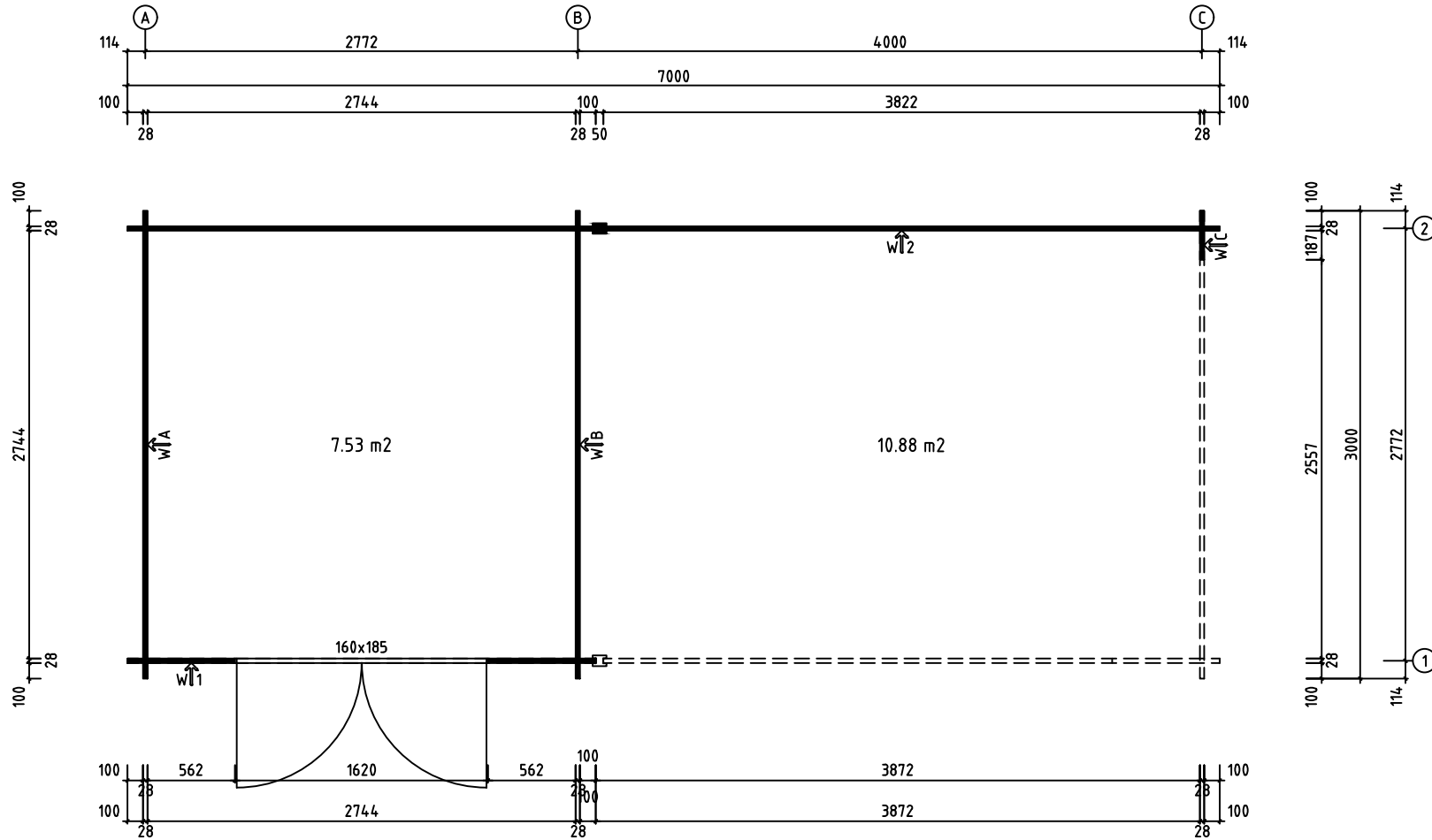
Model	Charlotta28	Page	
Client		Scale	1:30
Material	28x114mm	Date	09.04.2020
Company		File	Charlotta28.dwg

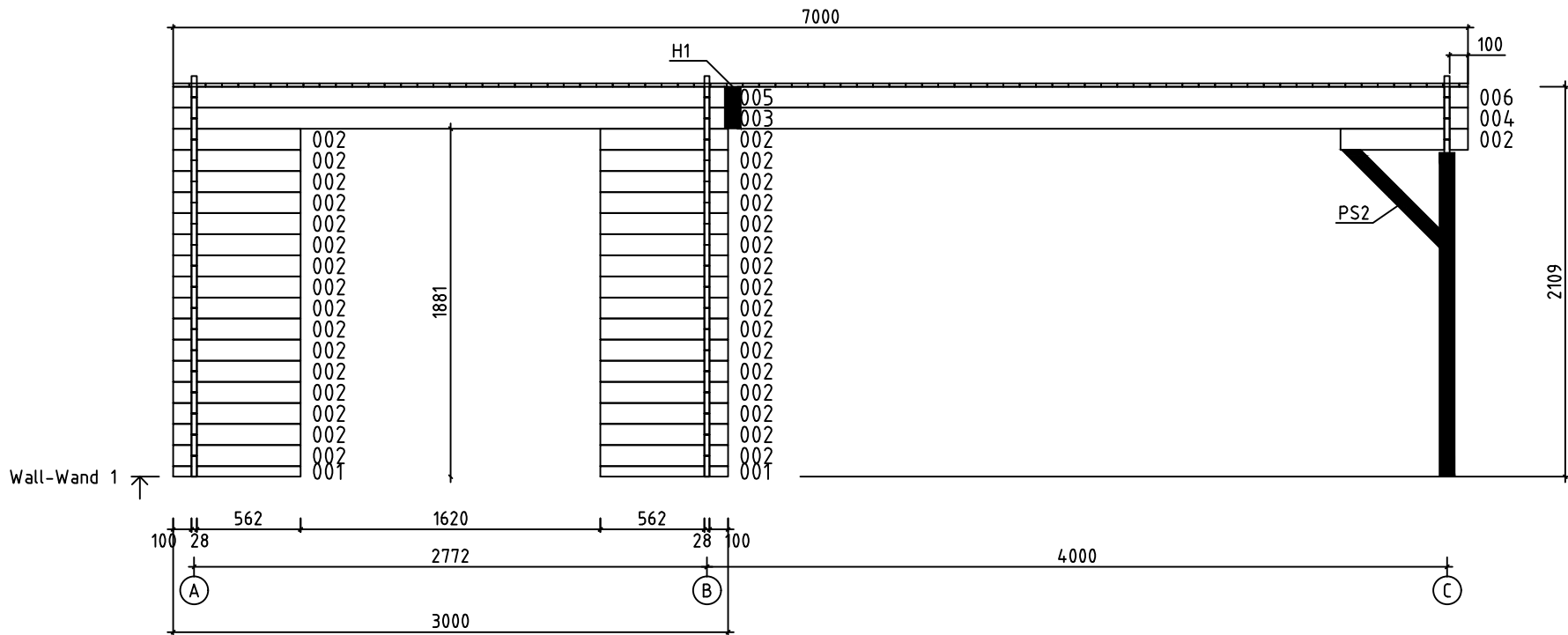

Model	Charlotta28	Page	5
Client		Scale	1:30
Material	2.8x11.4	Date	09.04.2020
Company		File	Charlotta28.dwg

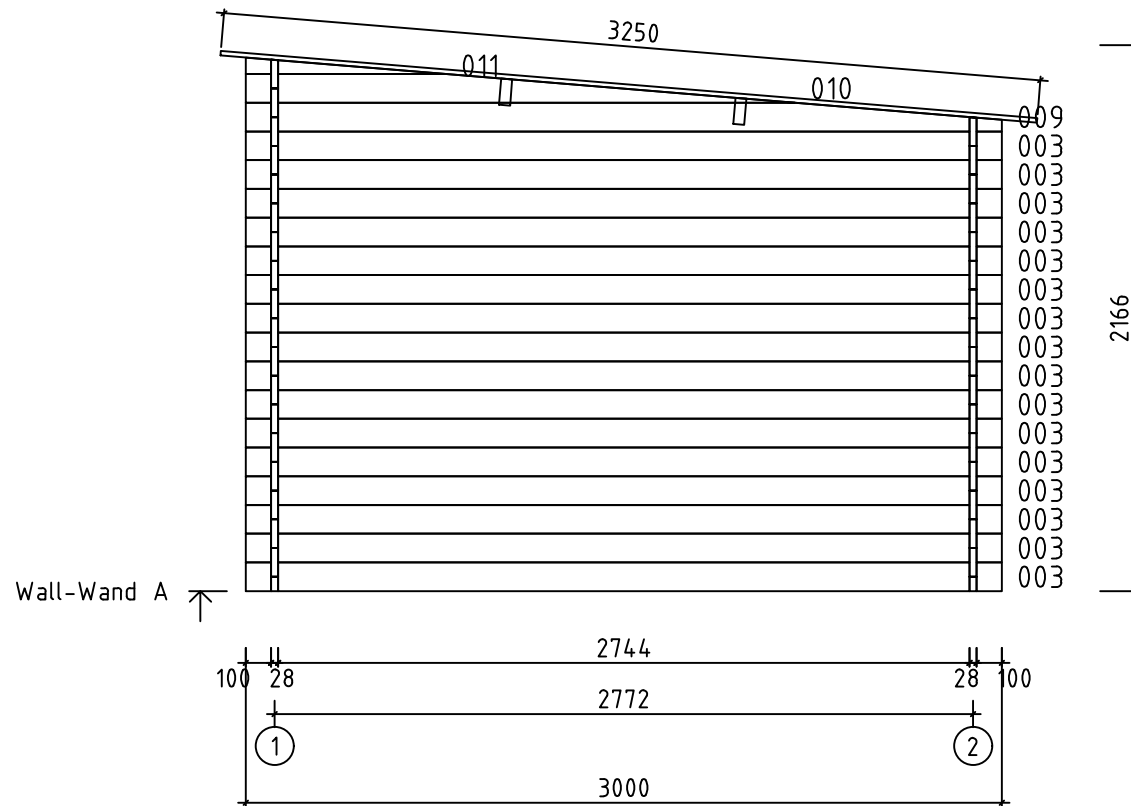

Model	Charlotta28	Page	2
Client		Scale	1:30
Material	2.8x11.4	Date	09.04.2020
Company		File	Charlotta28.dwg

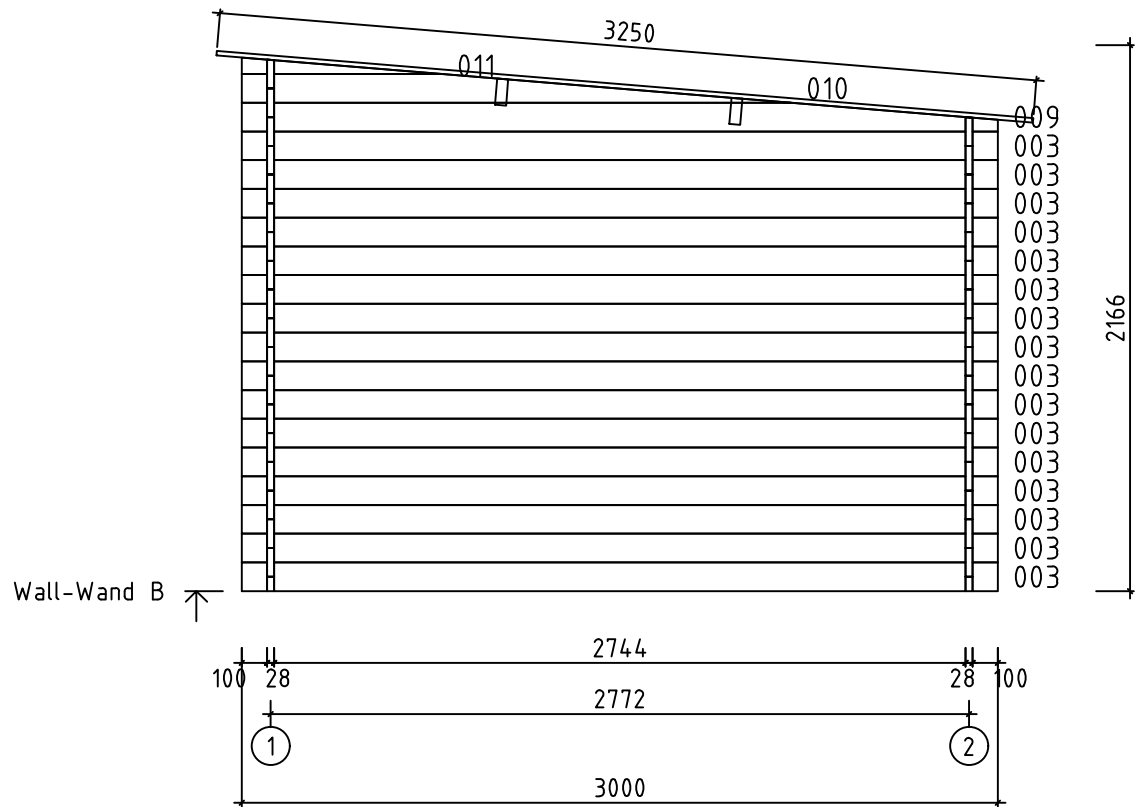

Model	Charlotta28	Page	3
Client		Scale	1:30
Material	2.8x11.4	Date	09.04.2020
Company		File	Charlotta28.dwg

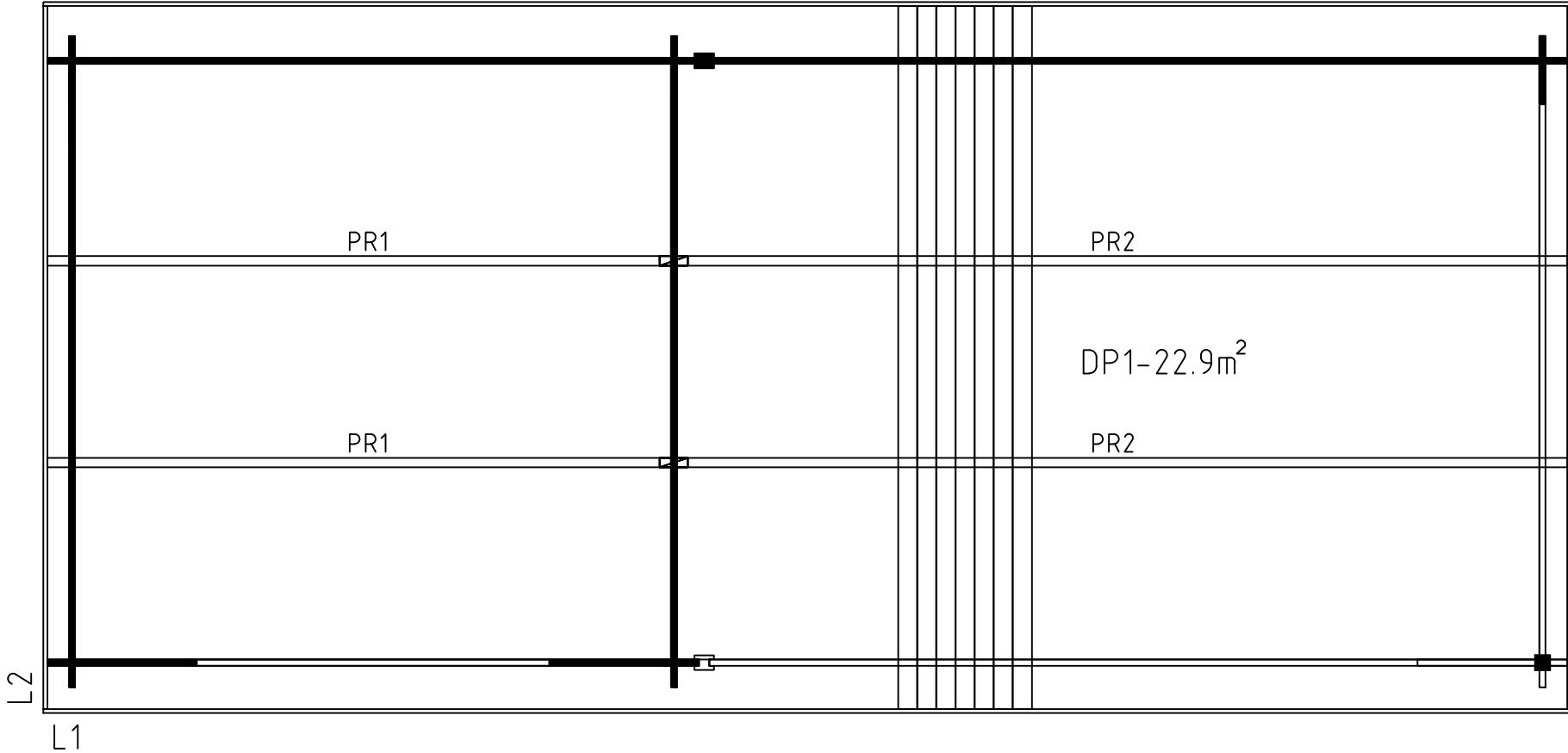
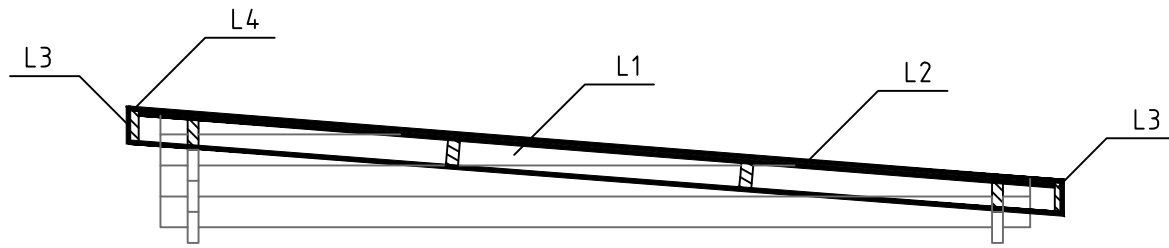

Model	Charlotta28	Page	
Client		Scale	1:30
Material	28x114mm	Date	09.04.2020
Company		File	Charlotta28.dwg

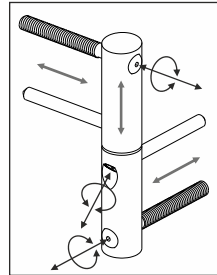
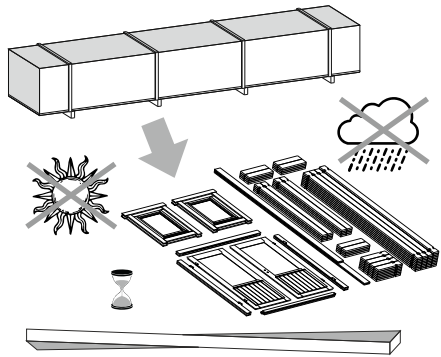
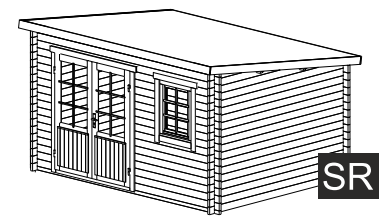
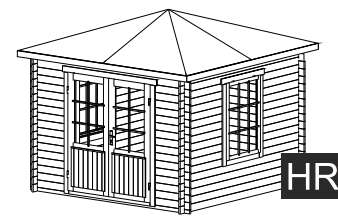
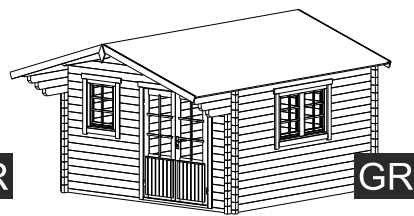
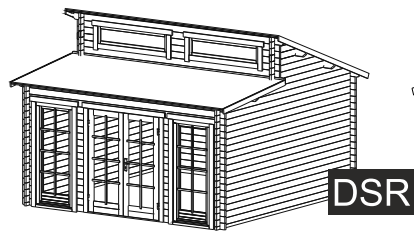
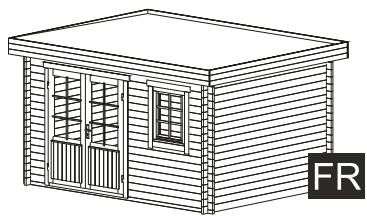

3.

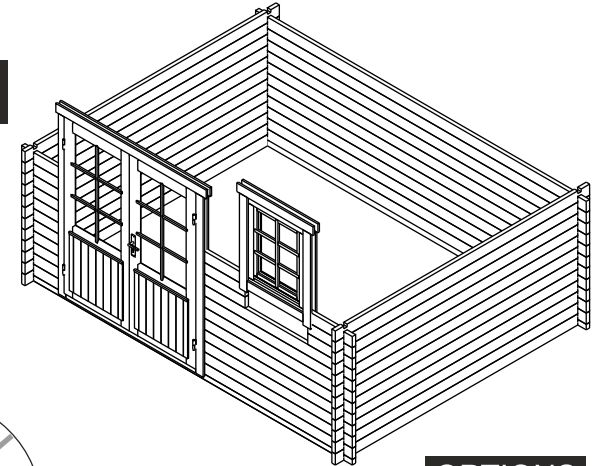

1.

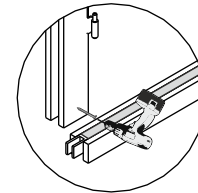
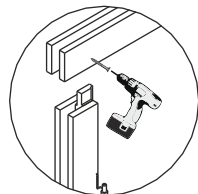
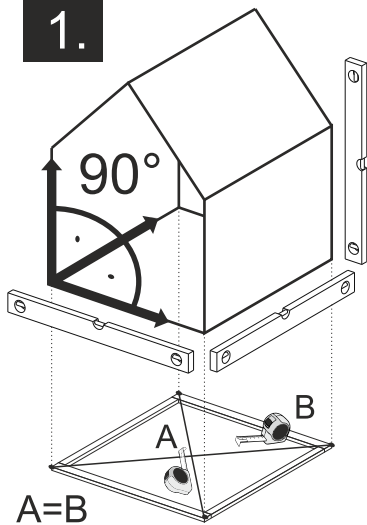

2.

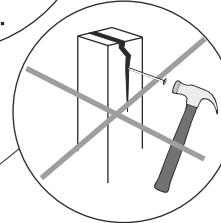
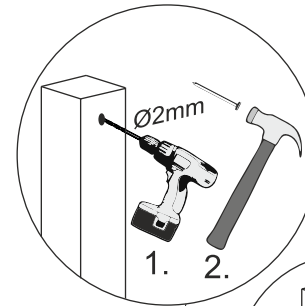
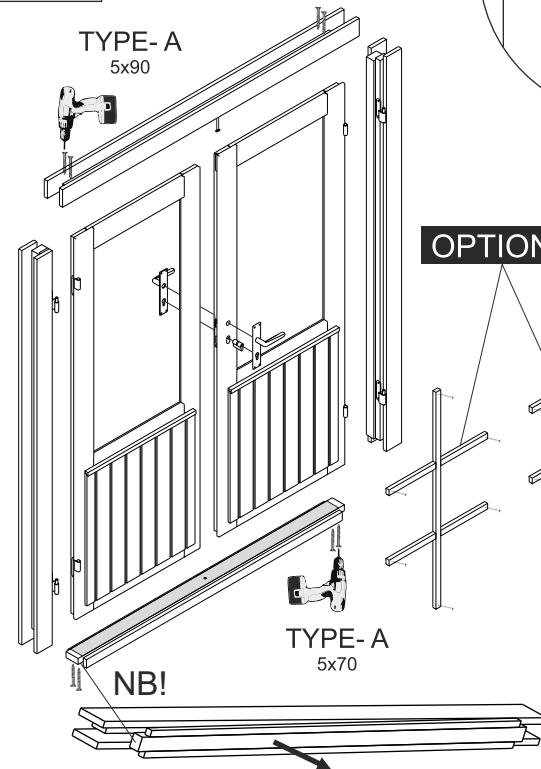

4.

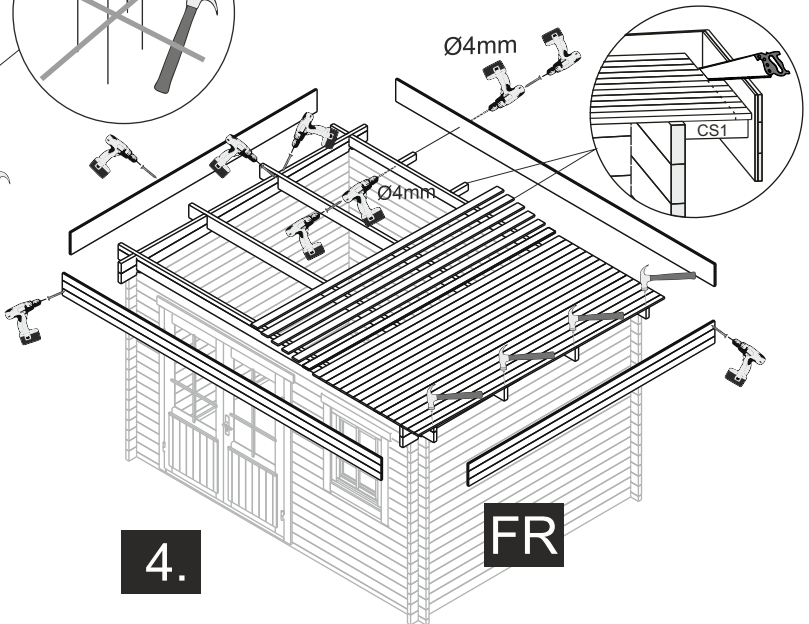

The guide is illustrative. This guide is not project specification.
Der Leitfaden ist illustrativ. Dieser Leitfaden ist keine Projektspezifikation.
De gids is illustratief. Deze gids is geen projectspecificatie.

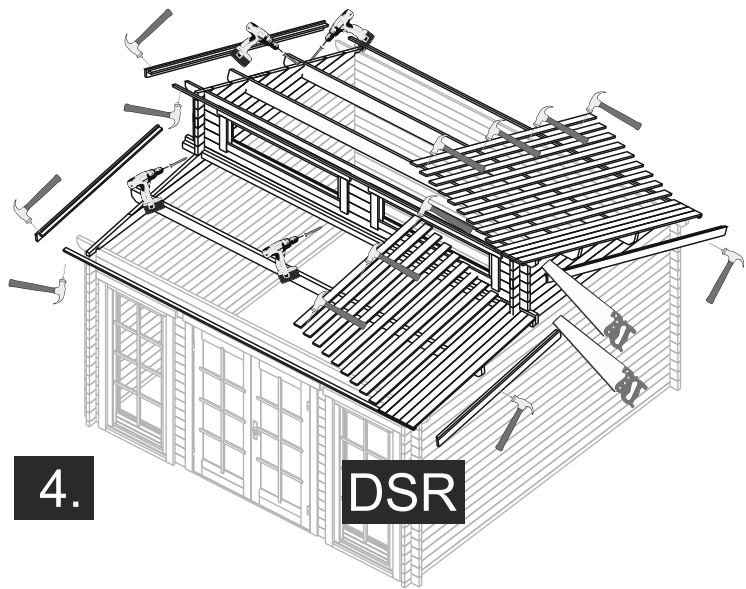

DSR

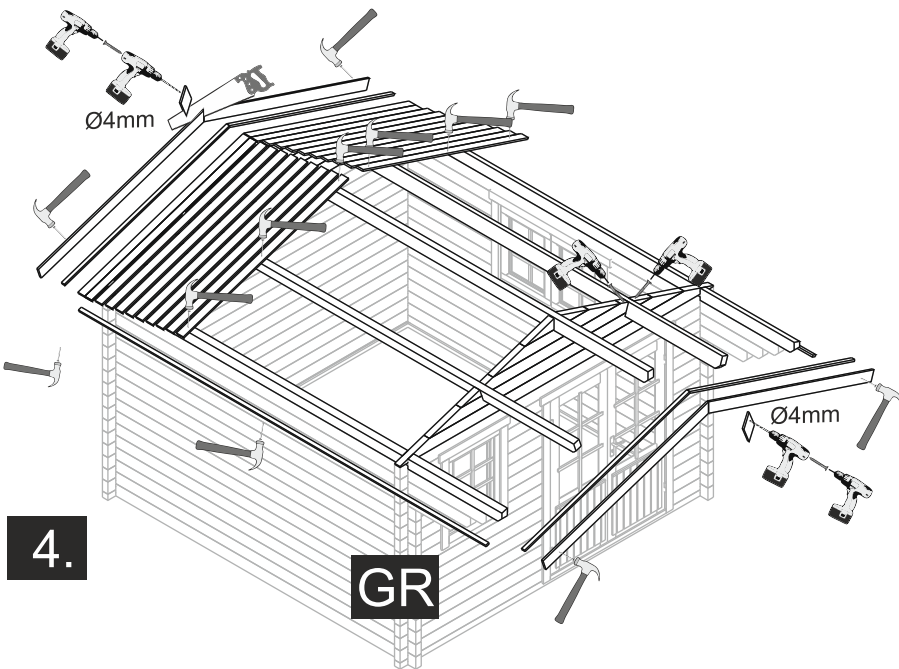

GR

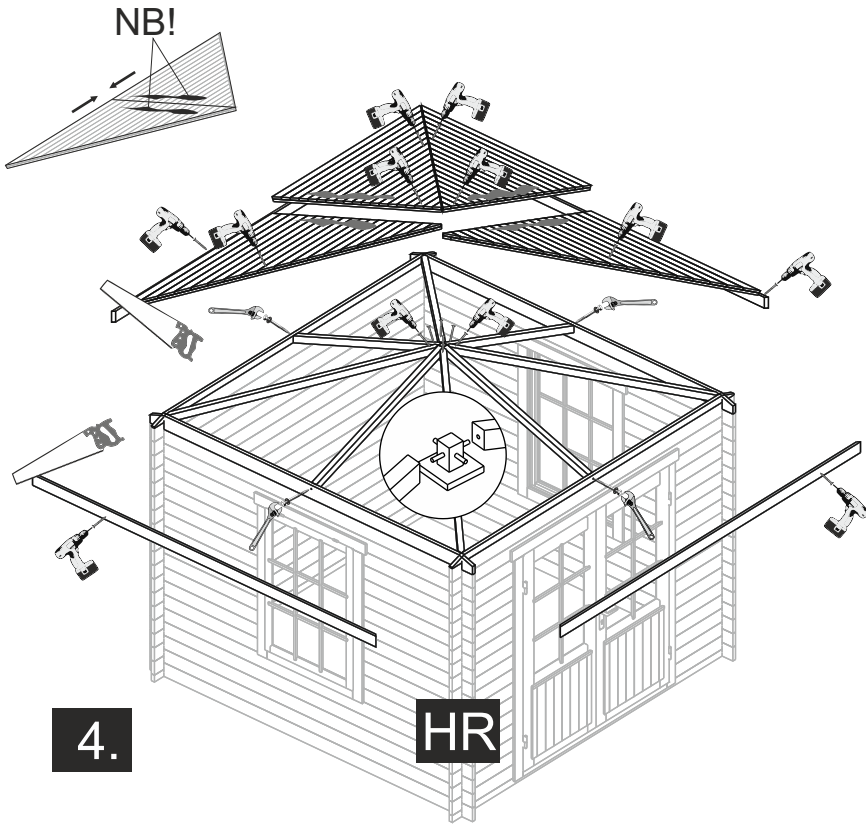

HR

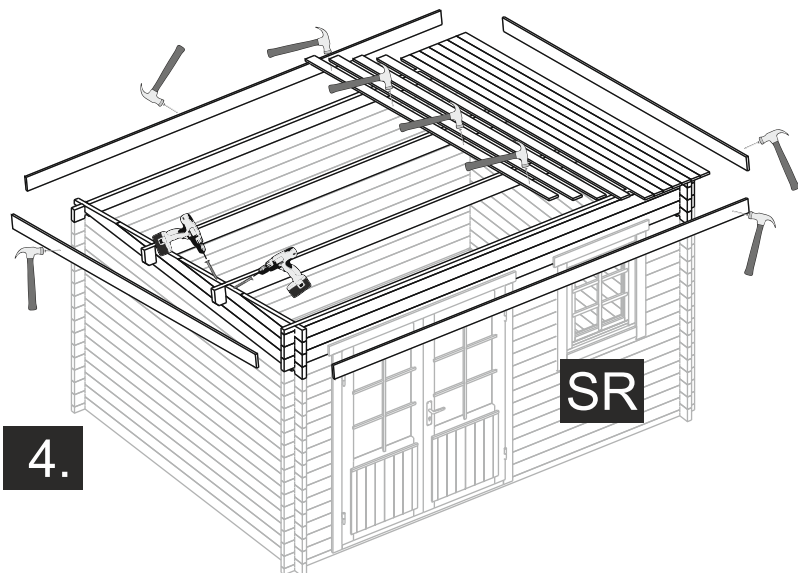

SR

OPTIONS

