



















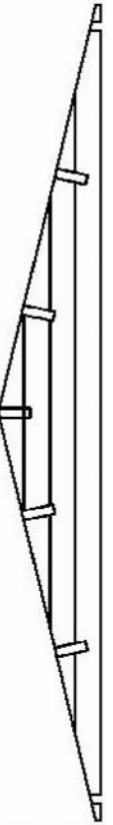

Pos	DERBY 4,4 x 4,4 + 0,9 58x135	Profile	Length	St.
C1 D1		58x135 	5300	2
C2 D2			4930	2
D3			4660	1
C3			1397	1
C4 D4 B2		58x135 	4400	34
A3			4400	1
C5			4400	1
C6			1137	13
A2			560	28
A1 B1		58 x 67	4400	2
A4 B4 APEX		58x135	4400	2
14	ROOFING BOARDS 	19 x 85	2380	126
15	WINDOW 	2126 x 966		1
16	Block of doors 	3280 x 1938		1
18	Roof of cover fixture 	20x120 or 20x145	2430	4
19	Roof of cover fixture 	20x95	2450	4
26	Beam 	40x40	5300	2
27	ROOF JOIST 	58x145	5300	5
28	Diamond 			2



DERBY 4,4 x 4,4 + 0,9 58\135 mm

Wall B

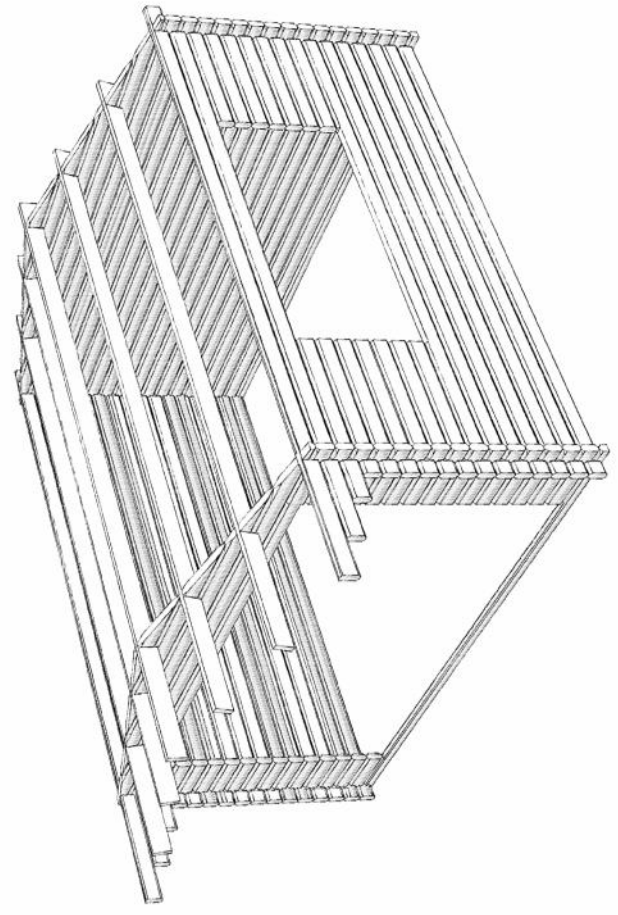
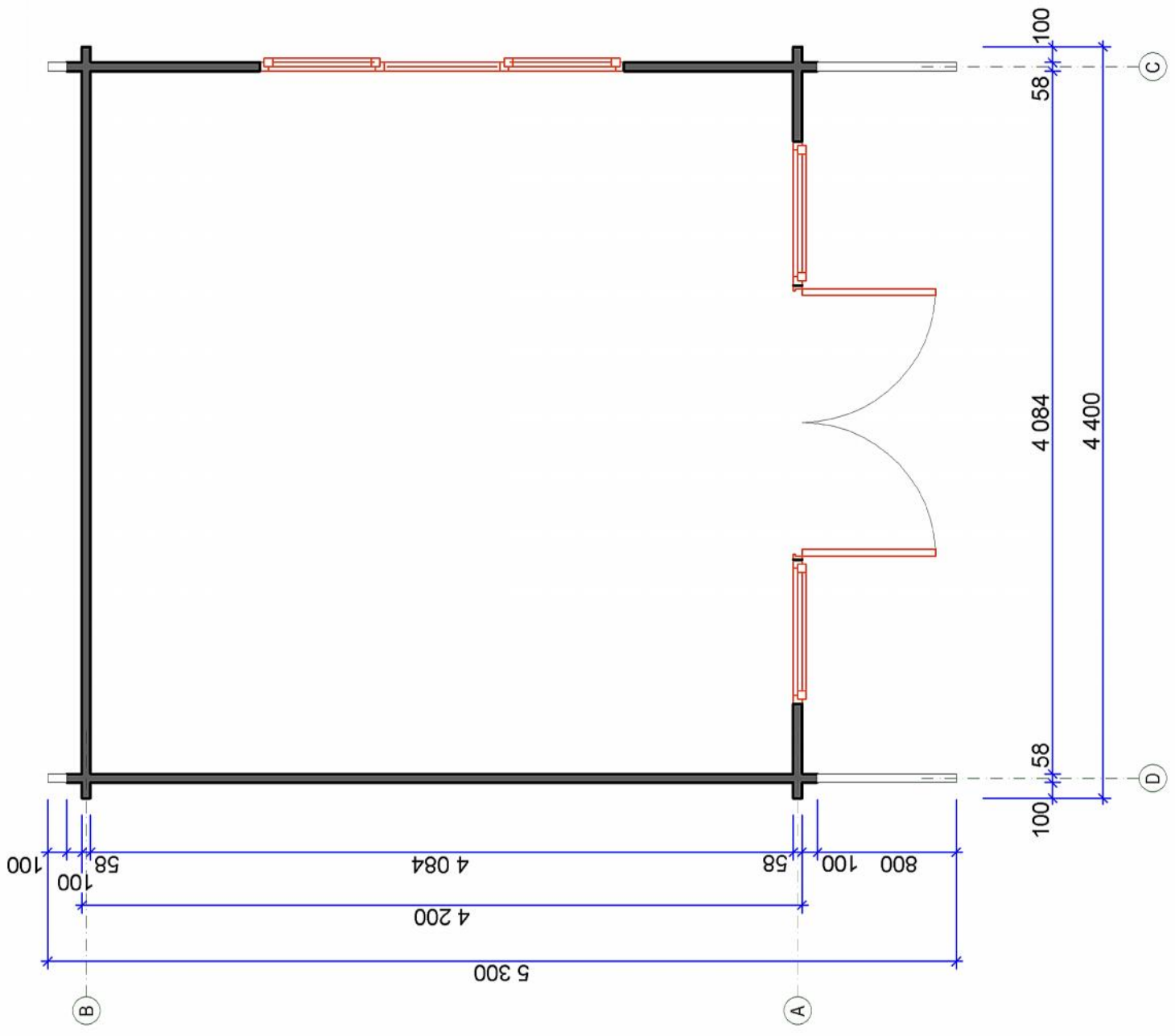
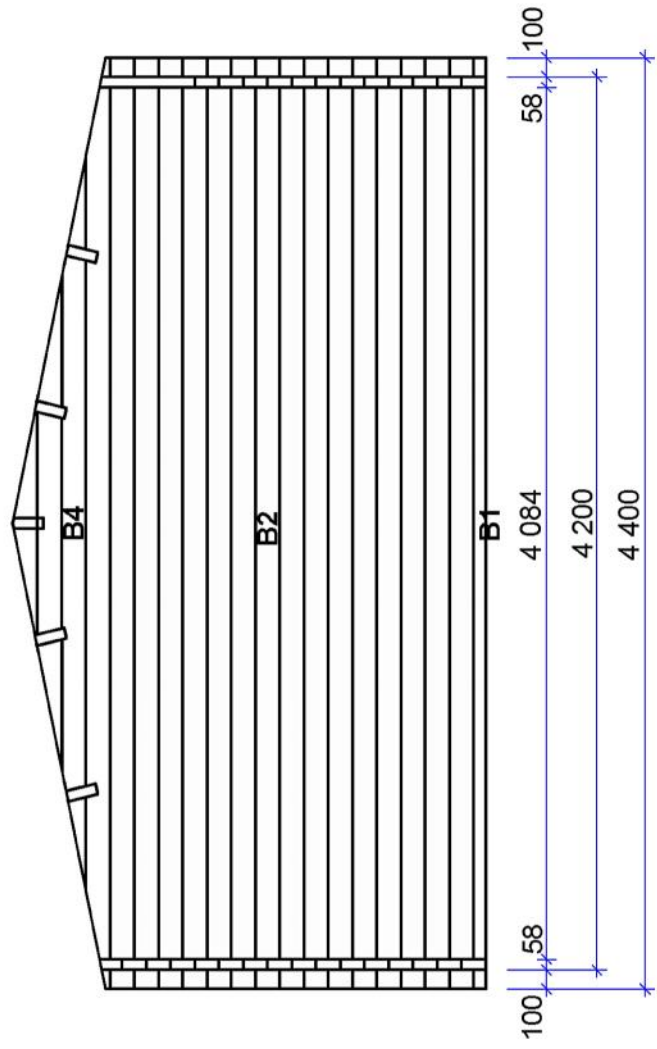

Wall A

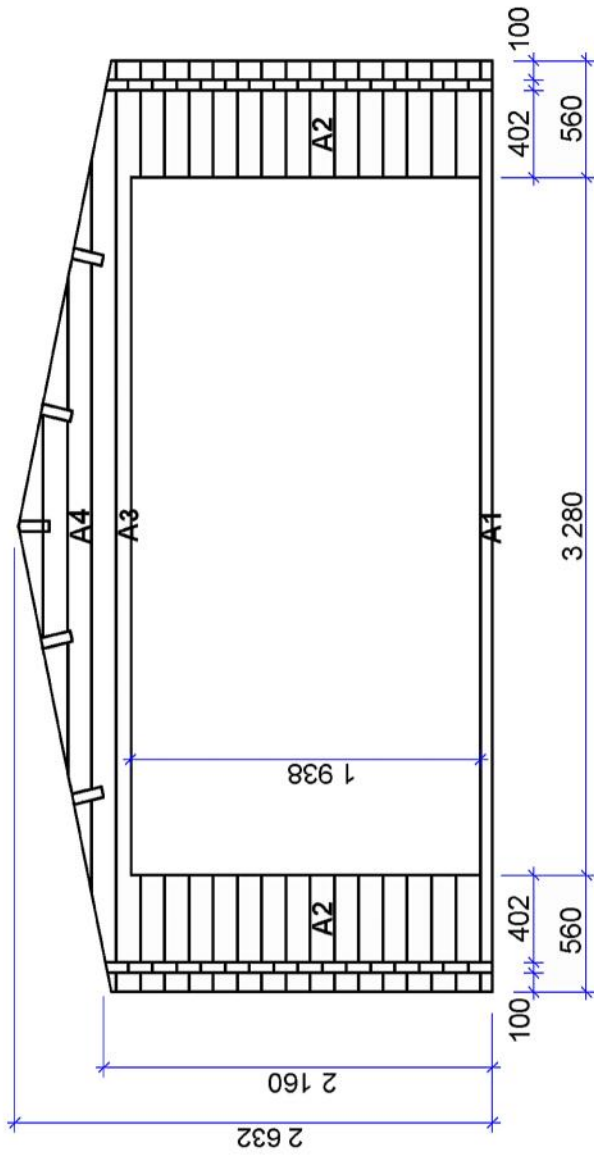

Wall C

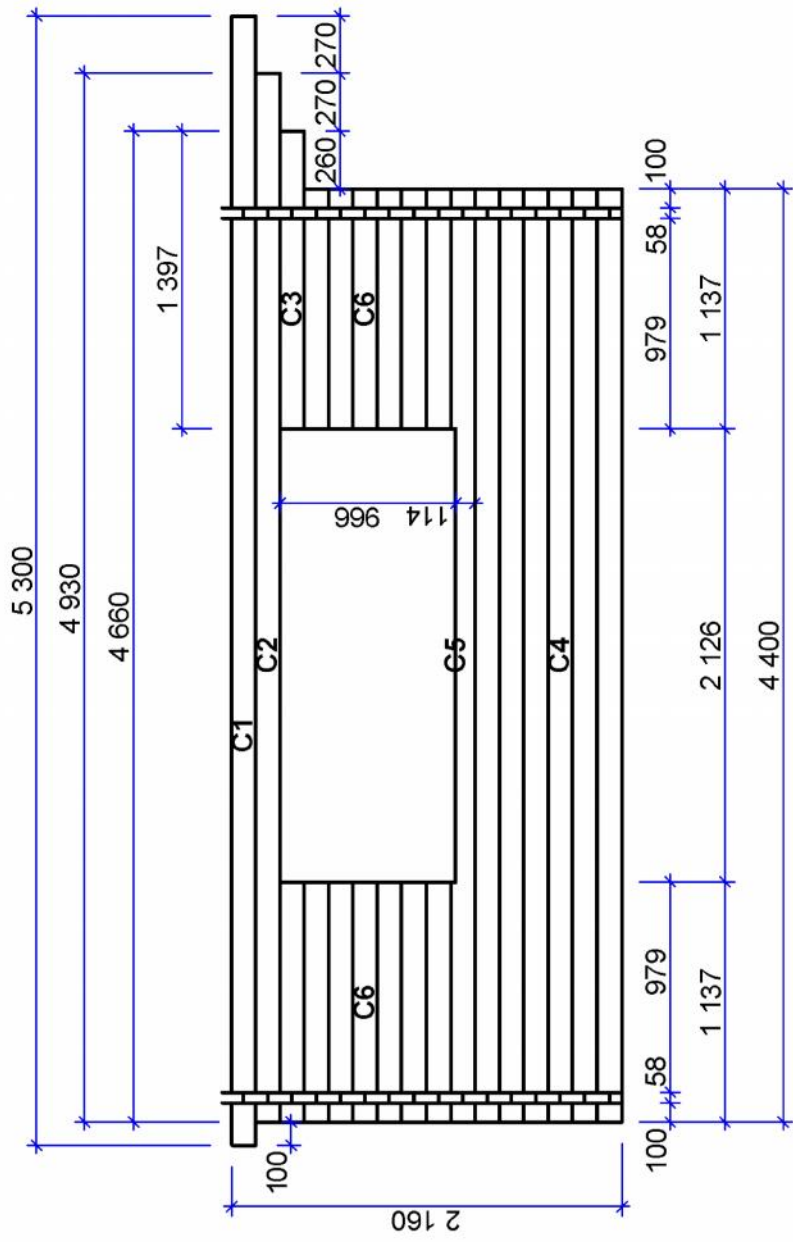

Wall D

