

Finn 92\135 mm PLAN

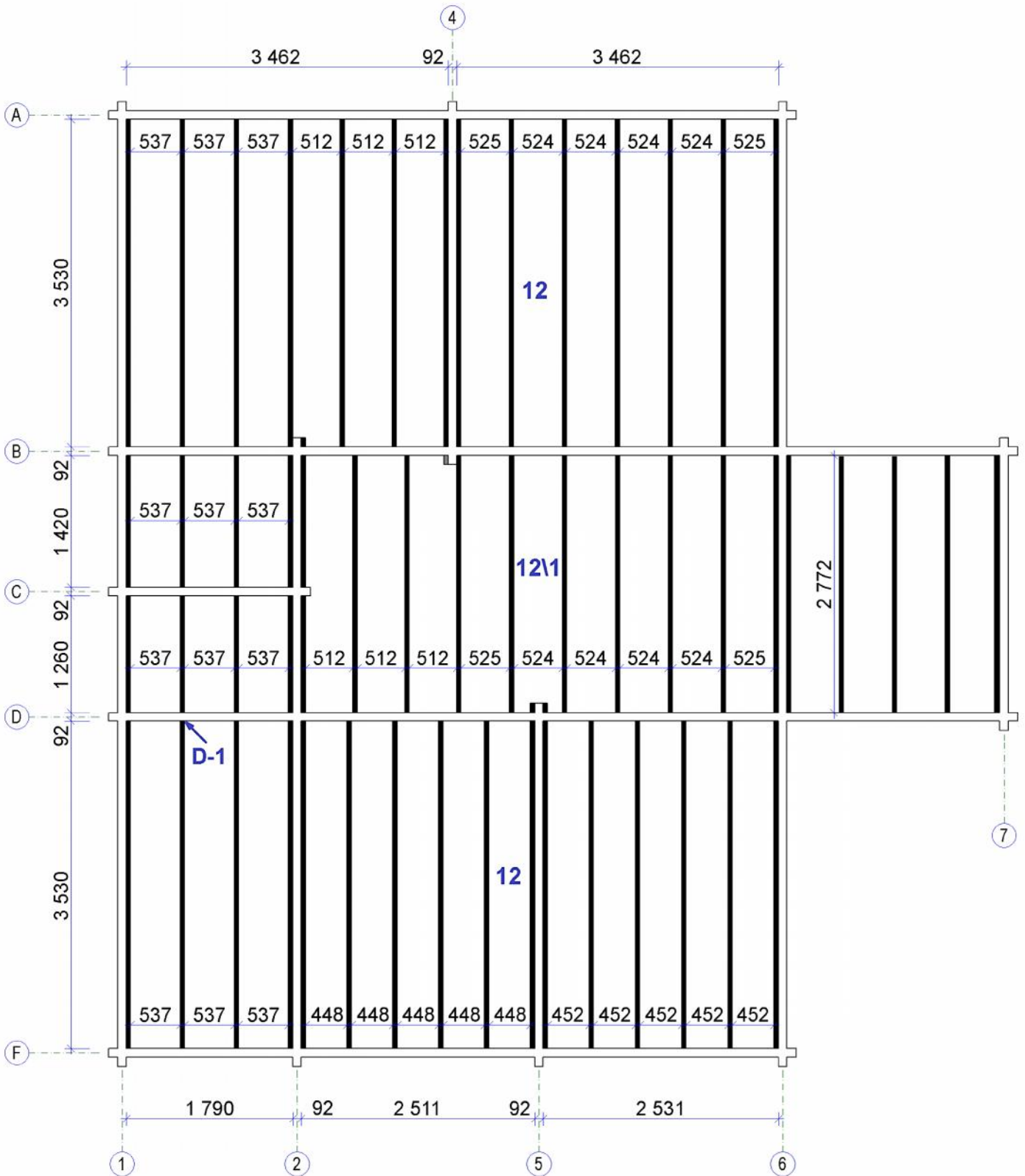

D-1

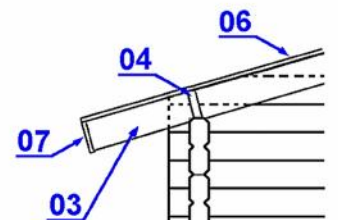

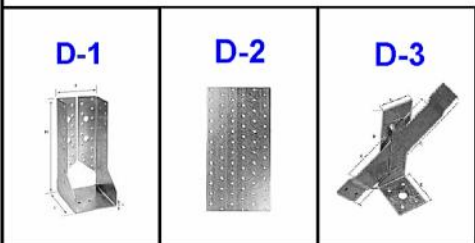
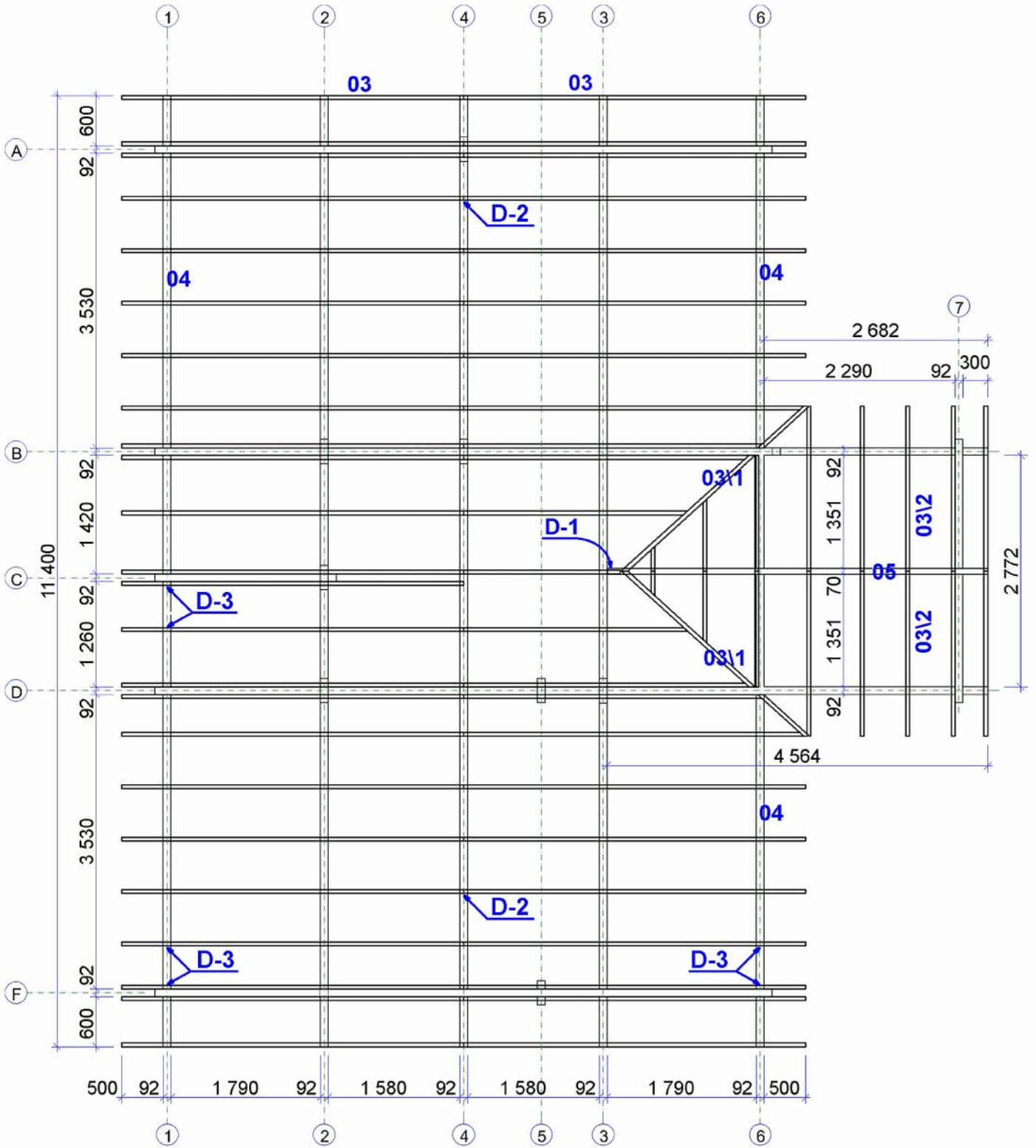

Finn 92\135 mm RAFTERS PLAN

### Wall 1

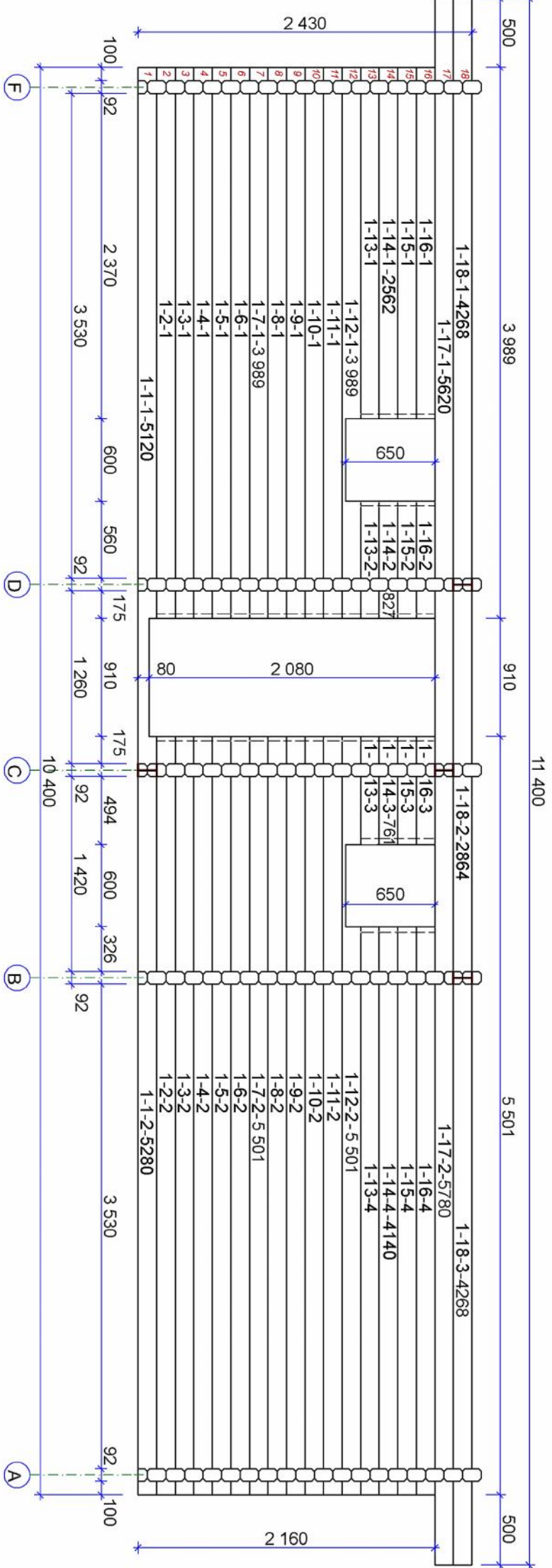

### Wall 3

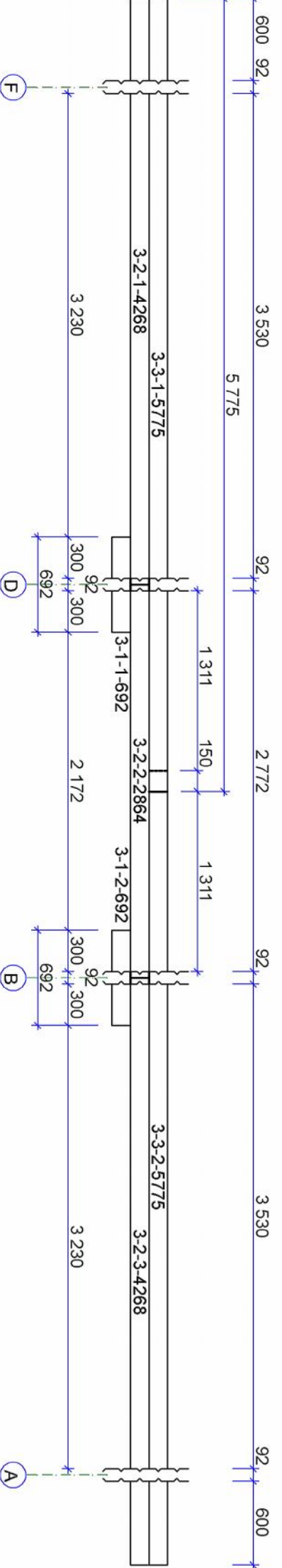

Finn 92/135 mm wall 1, wall 3

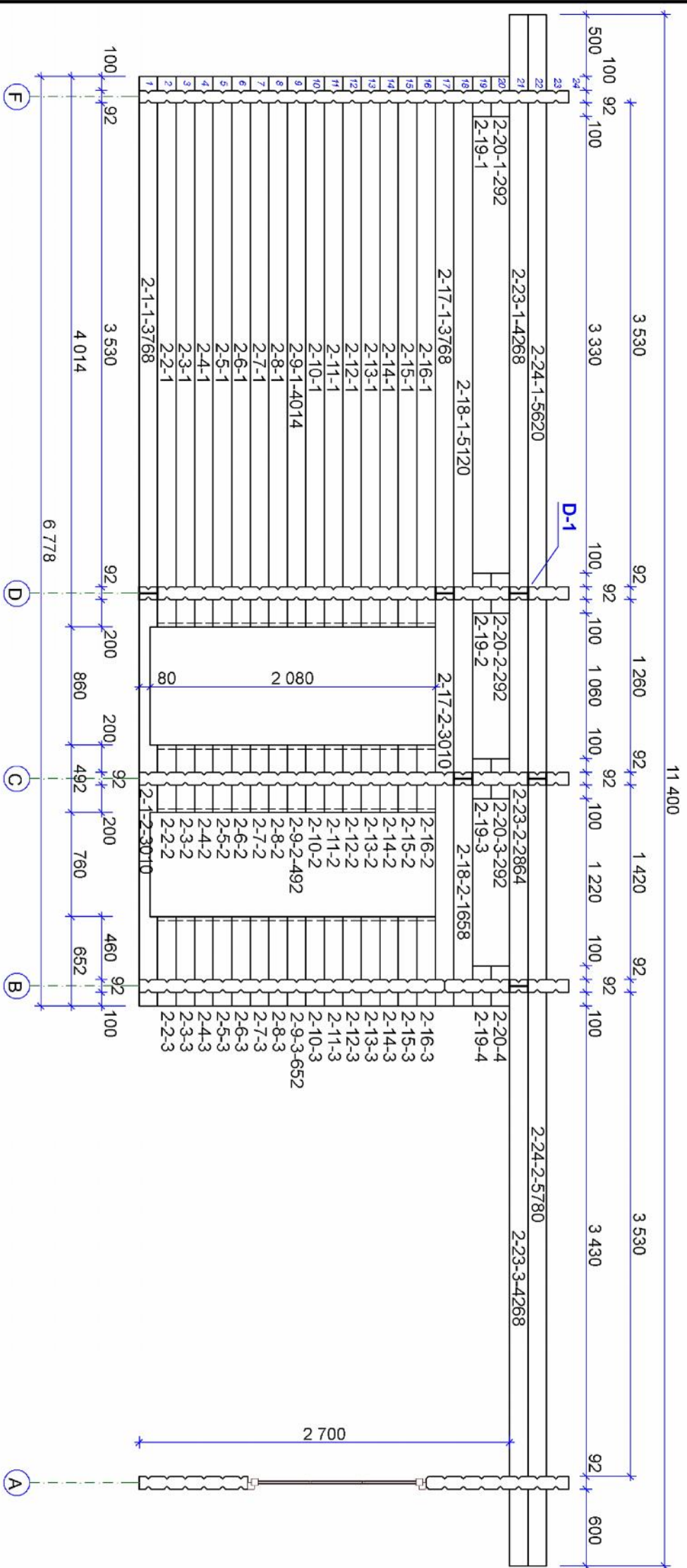

D-1

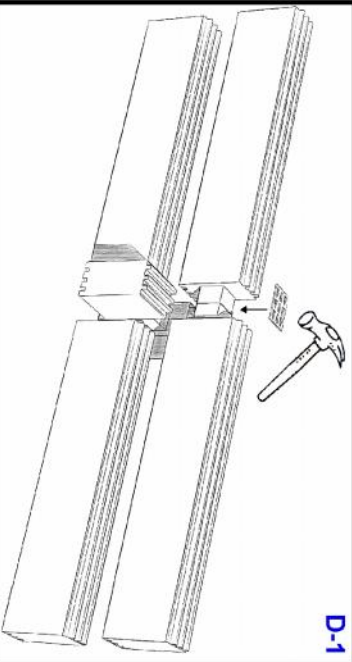

Finn 92\135 mm wall 2



# Wall 4

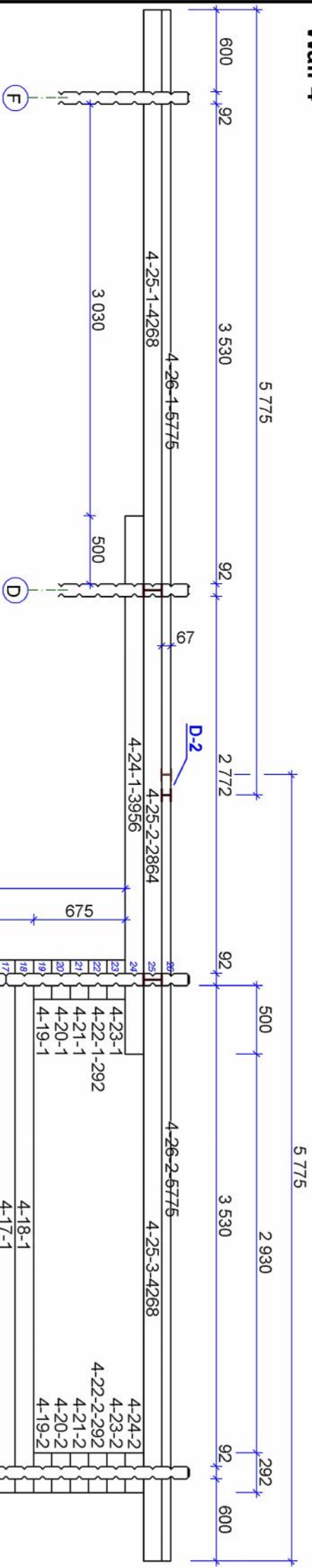

# Wall 7

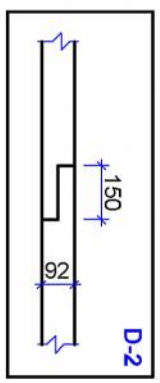
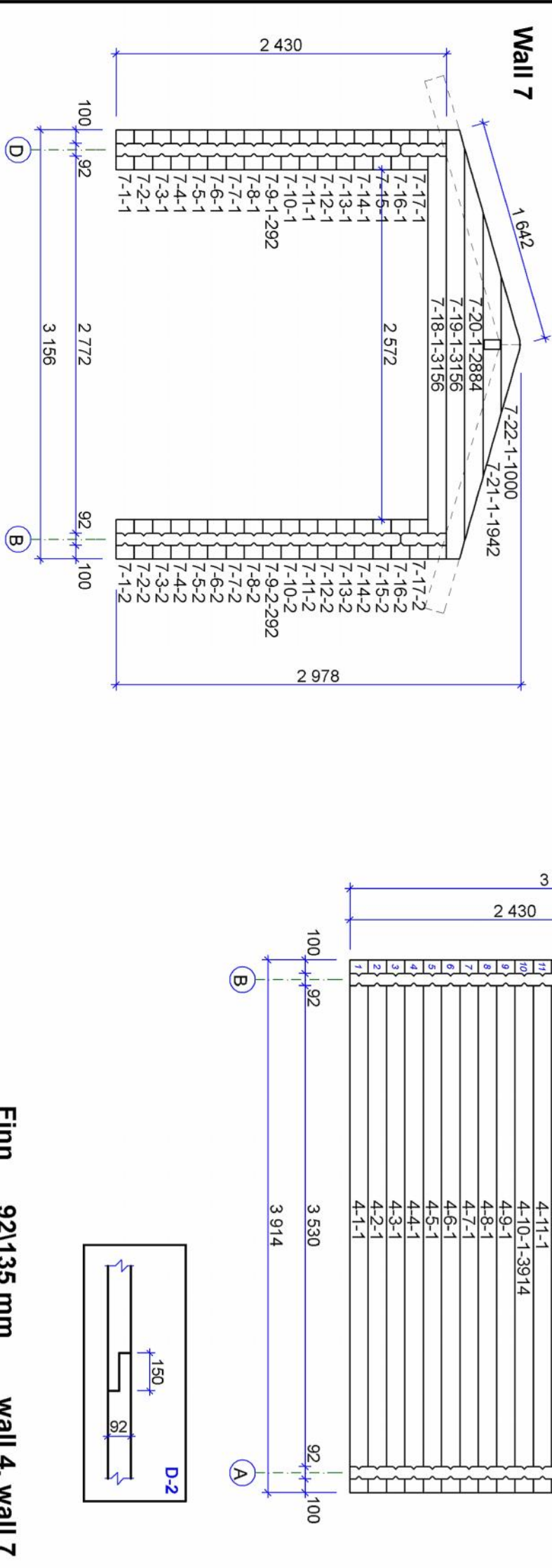

Finn 92x135 mm wall 4, wall 7

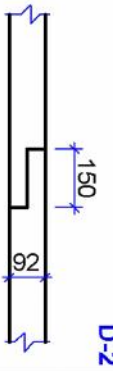
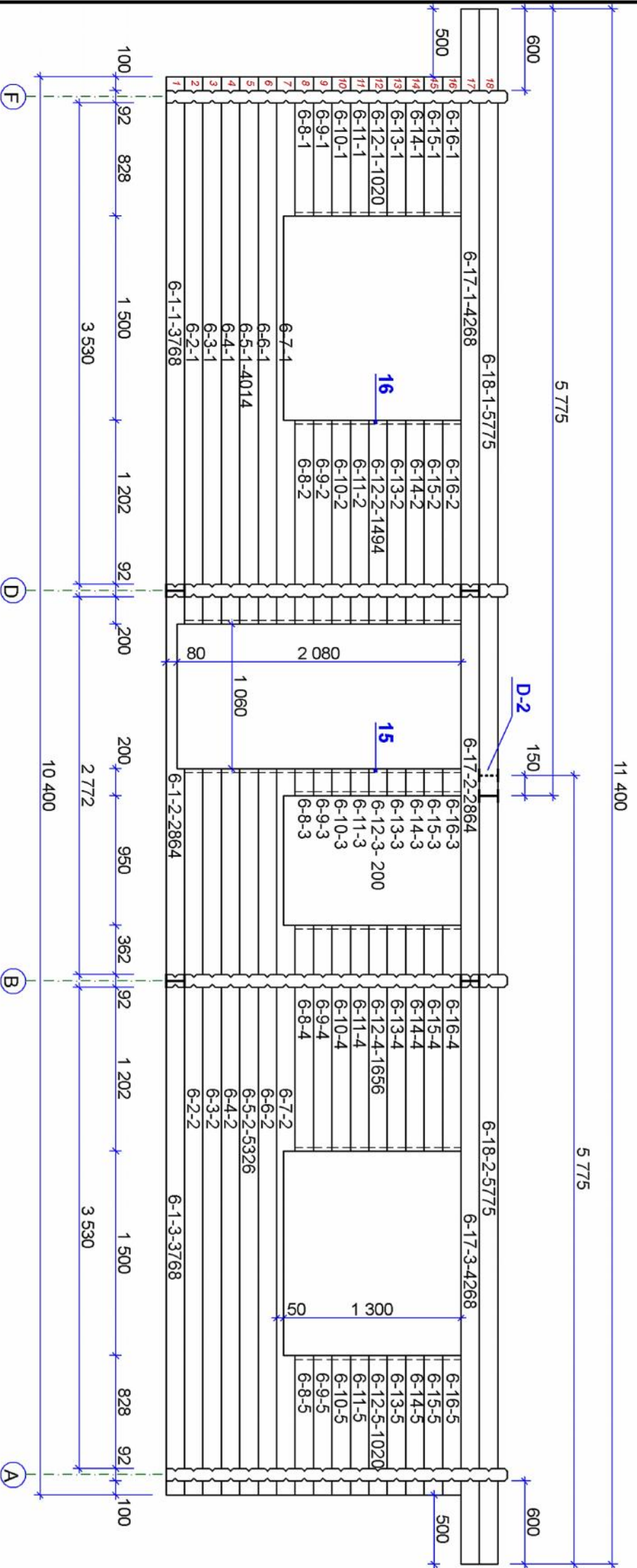

Finn 92\135 mm wall 6

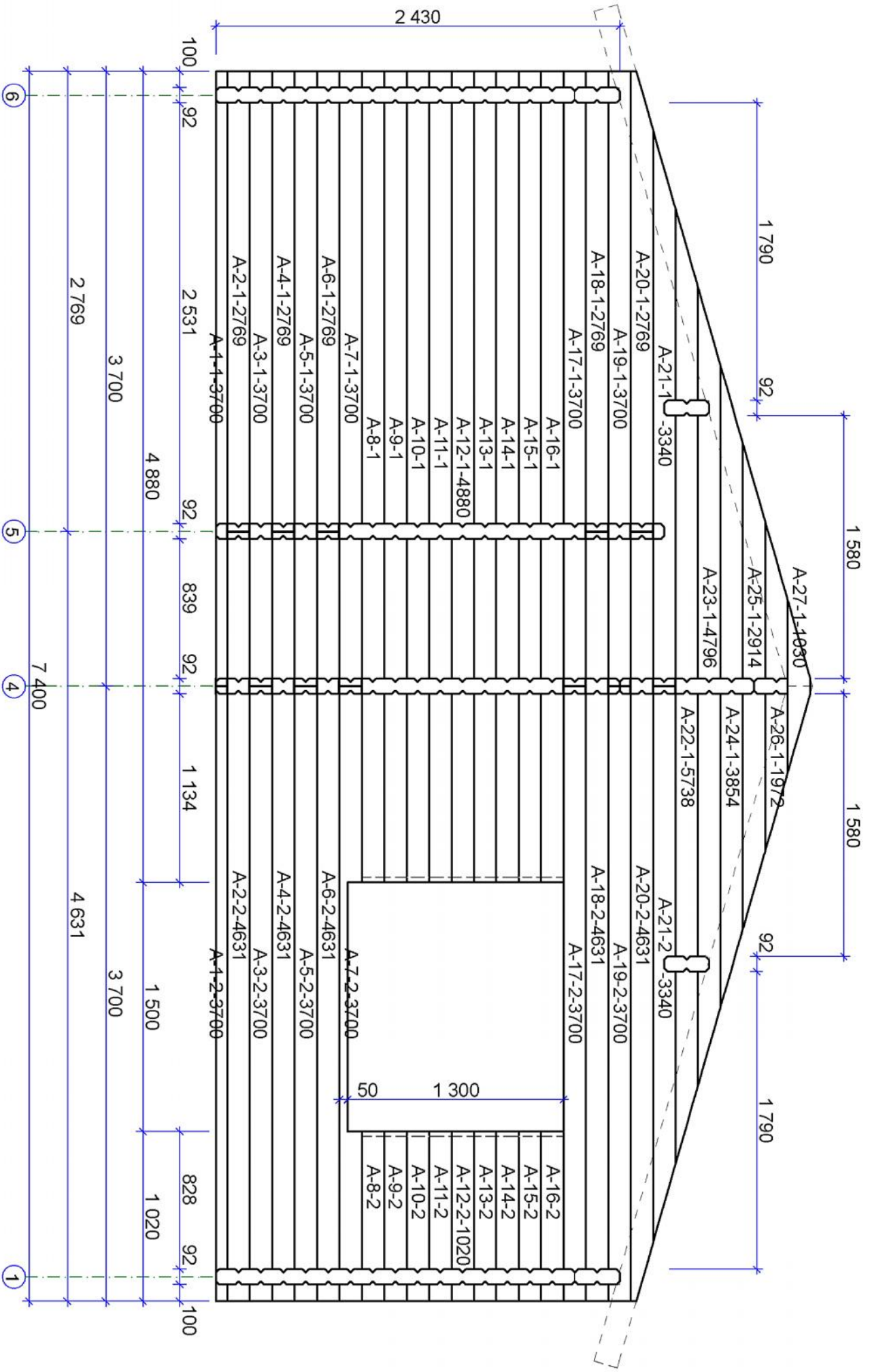

Finn 92\135 mm wall A



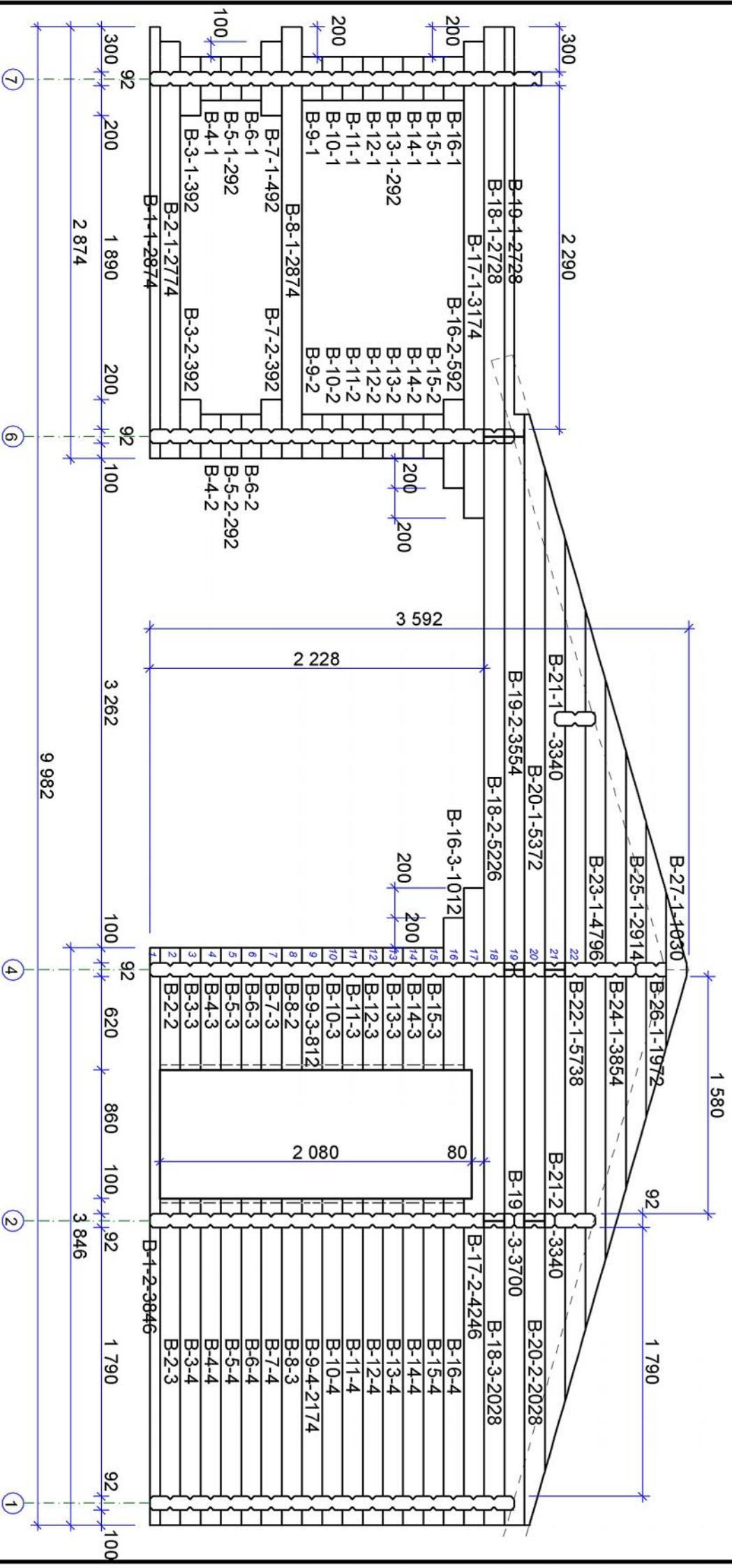

Finn 92\135 mm wall B

### Wall C

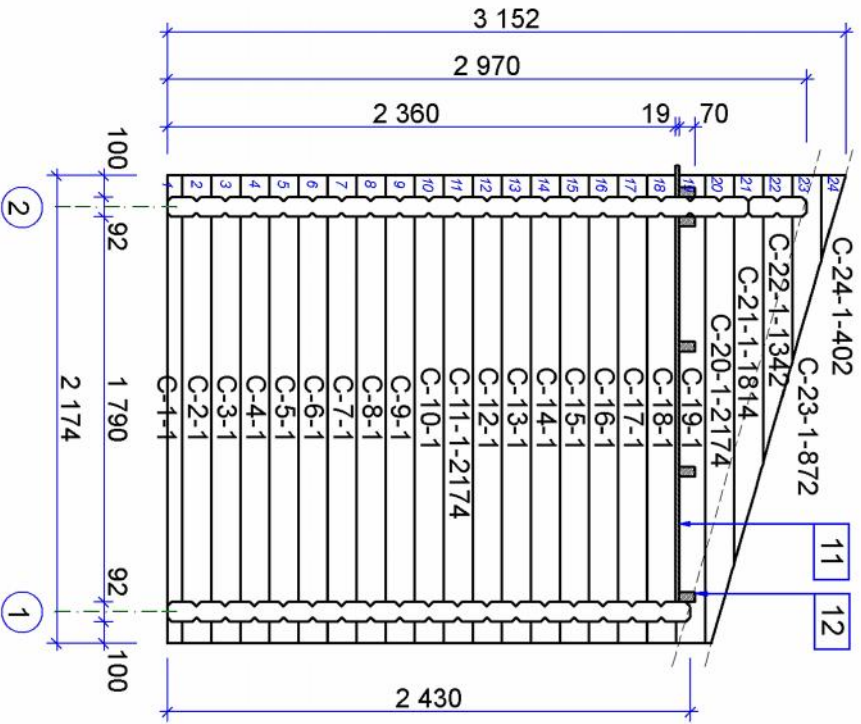

### Wall 5

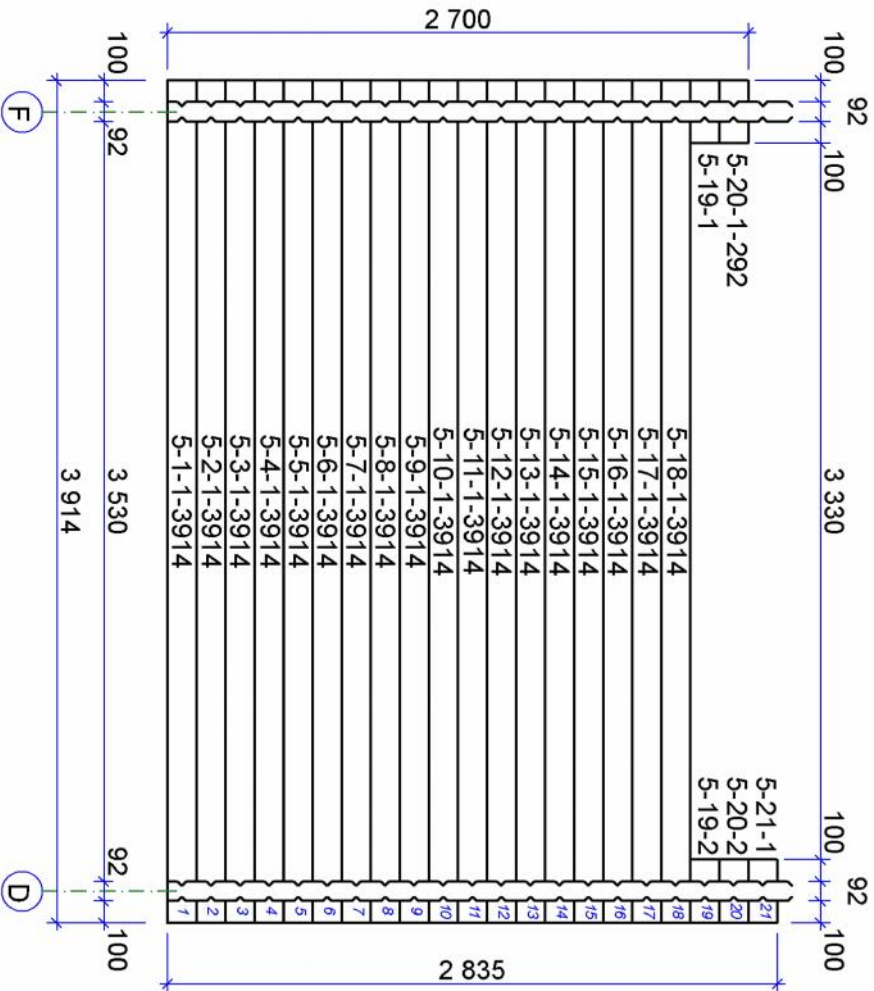

### Wall 5

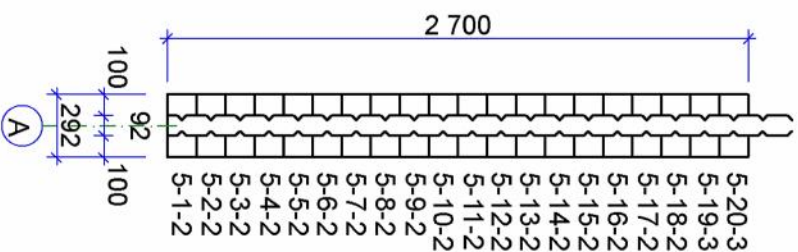



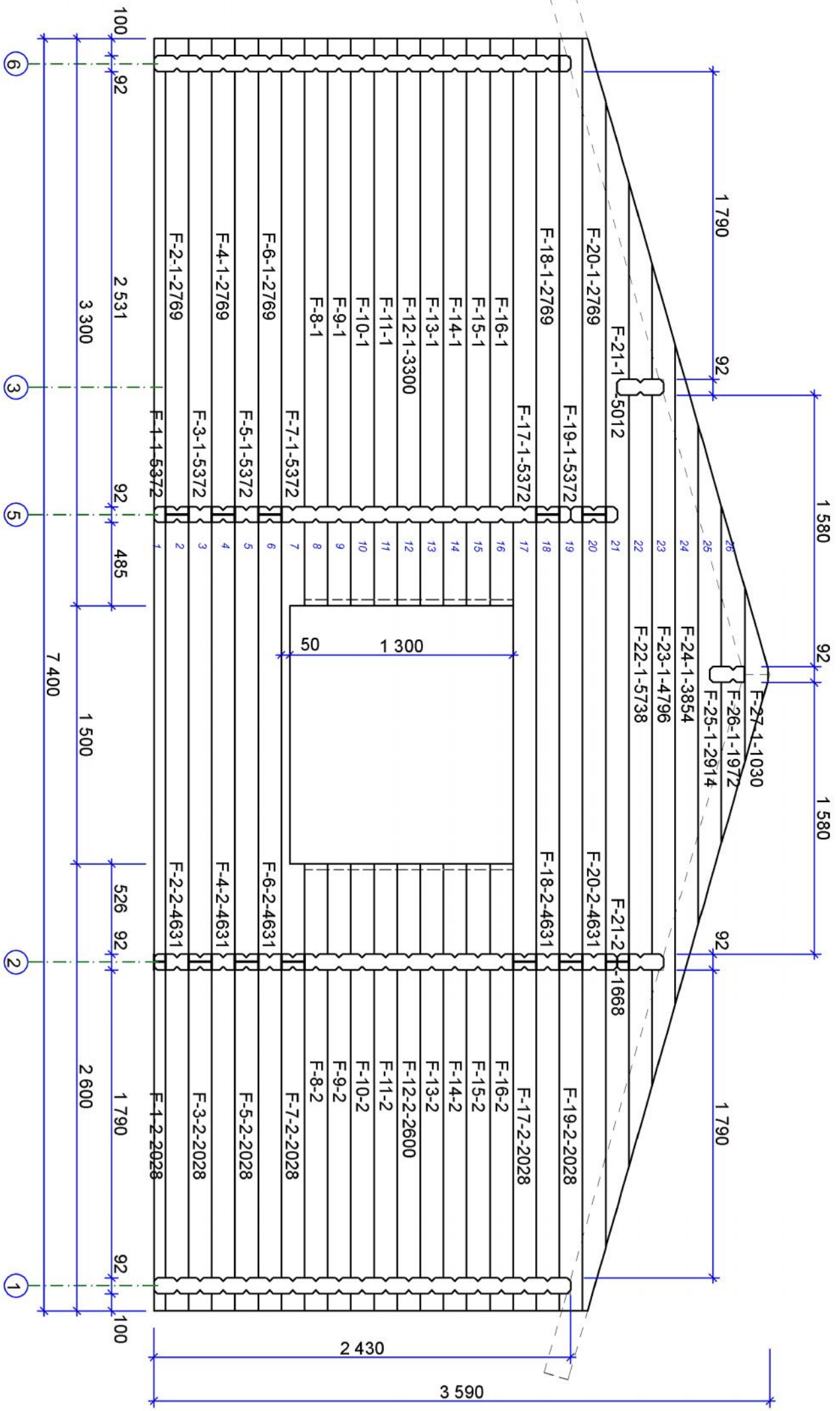

Finn 92\135 mm wall F



| Mont list №      |        |        |        |        | Wall     | B(mm)    | H(mm) | L (mm) | St. | Name                              |          |  |       |   |
|------------------|--------|--------|--------|--------|----------|----------|-------|--------|-----|-----------------------------------|----------|--|-------|---|
|                  | 4-26-1 | 4-26-2 |        |        | 4        | 92 x 67  |       | 5 775  | 2   | 92-full                           |          |  |       |   |
| <i>Без шипов</i> |        | 2-24-2 |        |        | 2        | 92 x 135 |       | 5 780  | 1   | 92-full                           |          |  |       |   |
|                  |        | 1-17-2 |        |        | 1        | 92 x 135 |       | 5 780  | 1   |                                   |          |  |       |   |
| <i>Без шипов</i> | 3-3-1  | 3-3-2  | 6-18-1 | 6-18-2 | 3, 6     | 92 x 135 |       | 5 775  | 4   |                                   |          |  |       |   |
| <i>Без шипов</i> |        |        | 2-24-1 |        | 2        | 92 x 135 |       | 5 620  | 1   |                                   |          |  |       |   |
|                  |        |        |        | 1-17-1 | 1        | 92 x 135 |       | 5 620  | 1   | 92-full<br><i>с одной стороны</i> |          |  |       |   |
| 1-2-2            | 1-3-2  | 1-4-2  | 1-5-2  | 1-6-2  | 1        | 92 x 135 |       | 5 501  | 10  |                                   |          |  |       |   |
| 1-7-2            | 1-8-2  | 1-9-2  | 1-10-2 | 1-11-2 |          |          |       |        |     |                                   |          |  |       |   |
|                  |        |        |        | 1-12-2 | 1        | 92 x 135 |       | 5 501  | 1   |                                   |          |  |       |   |
|                  | F-3-1  | F-5-1  | F-17-1 |        | F        | 92 x 135 |       | 5 372  | 3   | 92-full                           |          |  |       |   |
|                  |        |        | F-7-1  |        | F        | 92 x 135 |       | 5 372  | 1   |                                   |          |  |       |   |
|                  |        |        | F-19-1 |        | F        | 92 x 135 |       | 5 372  | 1   |                                   |          |  |       |   |
|                  |        |        | D-19-1 |        | D        | 92 x 135 |       | 5 351  | 1   |                                   |          |  |       |   |
| 6-2-2            | 6-3-2  | 6-4-2  | 6-5-2  | 6-6-2  | 6        | 92 x 135 |       | 5 326  | 5   | 92-full<br><i>с одной стороны</i> |          |  |       |   |
|                  |        |        |        | 6-7-2  | 6        | 92 x 135 |       | 5 326  | 1   |                                   |          |  |       |   |
|                  |        |        |        | 1-1-2  | 1        | 92 x 135 |       | 5 280  | 1   | 92-full                           |          |  |       |   |
|                  |        |        |        | B-18-2 | B        | 92 x 135 |       | 5 226  | 1   |                                   |          |  |       |   |
|                  |        |        |        | D-18-2 | D        | 93 x 135 |       | 5 226  | 1   |                                   |          |  |       |   |
|                  |        |        |        | 1-1-1  | 1        | 92 x 135 |       | 5 120  | 1   |                                   |          |  |       |   |
|                  |        |        |        | 2-18-1 | 2        | 92 x 135 |       | 5 120  | 1   |                                   |          |  |       |   |
|                  |        |        |        | D-17-2 | D        | 92 x 135 |       | 5 177  | 1   |                                   |          |  |       |   |
| A-8-1            | A-9-1  | A-10-1 | A-11-1 | A-12-1 | A        | 92 x 135 |       | 4 880  | 9   | 92-full<br><i>с одной стороны</i> |          |  |       |   |
|                  | A-13-1 | A-14-1 | A-15-1 | A-16-1 |          |          |       |        |     |                                   |          |  |       |   |
|                  | A-2-2  | A-4-2  | A-6-2  | A-18-2 | A        | 92 x 135 |       | 4 631  | 4   | 92-full                           |          |  |       |   |
|                  |        |        |        | D-19-2 | D        | 92 x 135 |       | 4 631  | 1   |                                   |          |  |       |   |
|                  | F-2-2  | F-4-2  | F-6-2  | F-18-2 | F        | 92 x 135 |       | 4 631  | 4   |                                   |          |  |       |   |
| <i>Без шипов</i> |        |        | 1-18-1 | 1-18-3 | 1        | 92 x 135 |       | 4 268  | 2   |                                   |          |  |       |   |
|                  | 4-25-1 | 4-25-3 | 6-17-1 | 6-17-3 | 4, 6     | 92 x 135 |       | 4 268  | 4   |                                   |          |  |       |   |
|                  | 2-23-1 | 2-23-3 | 3-2-1  | 3-2-3  | 2, 3     | 92 x 135 |       | 4 268  | 4   |                                   |          |  |       |   |
|                  |        |        |        | B-17-2 | B        | 92 x 135 |       | 4 246  | 1   |                                   |          |  |       |   |
|                  | 1-13-4 | 1-14-4 | 1-15-4 | 1-16-4 | 1        | 92 x 135 |       | 4 140  | 4   | 92-full<br><i>с одной стороны</i> |          |  |       |   |
| 6-2-1            | 6-3-1  | 6-4-1  | 6-5-1  | 6-6-1  | 6        | 92 x 135 |       | 4 014  | 5   |                                   |          |  |       |   |
|                  |        |        |        | 6-7-1  | 6        | 92 x 135 |       | 4 014  | 1   |                                   |          |  |       |   |
| 2-2-1            | 2-3-1  | 2-4-1  | 2-5-1  | 2-6-1  | 2        | 92 x 135 |       | 4 014  | 15  |                                   |          |  |       |   |
| 2-7-1            | 2-8-1  | 2-9-1  | 2-10-1 | 2-11-1 |          |          |       |        |     |                                   |          |  |       |   |
| 2-12-1           | 2-13-1 | 2-14-1 | 2-15-1 | 2-16-1 |          |          |       |        |     |                                   |          |  |       |   |
|                  |        |        |        | 1-12-1 | 1        | 92 x 135 |       | 3 989  | 1   |                                   |          |  |       |   |
| 1-2-1            | 1-3-1  | 1-4-1  | 1-5-1  | 1-6-1  | 1        | 92 x 135 |       | 3 989  | 10  |                                   |          |  |       |   |
| 1-7-1            | 1-8-1  | 1-9-1  | 1-10-1 | 1-11-1 |          |          |       |        |     |                                   |          |  |       |   |
|                  |        |        |        | 4-24-1 | 4        | 92 x 135 |       | 3 956  | 1   |                                   |          |  |       |   |
| 4-1-1            | 4-2-1  | 4-3-1  | 4-4-1  | 4-5-1  | 4, 5     | 92 x 135 |       | 3 914  | 36  | 92-full                           |          |  |       |   |
| 4-6-1            | 4-7-1  | 4-8-1  | 4-9-1  | 4-10-1 |          |          |       |        |     |                                   |          |  |       |   |
| 4-11-1           | 4-12-1 | 4-13-1 | 4-14-1 | 4-15-1 |          |          |       |        |     |                                   |          |  |       |   |
| 4-16-1           | 4-17-1 | 4-18-1 | 5-1-1  | 5-2-1  |          |          |       |        |     |                                   |          |  |       |   |
| 5-3-1            | 5-4-1  | 5-5-1  | 5-6-1  | 5-7-1  |          |          |       |        |     |                                   |          |  |       |   |
| 5-8-1            | 5-9-1  | 5-10-1 | 5-11-1 | 5-12-1 |          |          |       |        |     |                                   |          |  |       |   |
| 5-13-1           | 5-14-1 | 5-15-1 | 5-16-1 | 5-17-1 |          |          |       |        |     |                                   |          |  |       |   |
|                  |        |        |        | 5-18-1 |          |          |       |        |     |                                   |          |  |       |   |
| 2-1-1            | 2-17-1 | 6-1-1  | 6-1-3  | 2, 6   |          |          |       |        |     |                                   | 92 x 135 |  | 3 768 | 4 |
| A-3-1            | A-5-1  | A-7-1  | A-17-1 | A      |          |          |       |        |     |                                   | 92 x 135 |  | 3 700 | 4 |
|                  | A-3-2  | A-5-2  | A-17-2 | A      | 92 x 135 |          | 3 700 | 3      |     |                                   |          |  |       |   |
|                  |        |        | A-7-2  | A      | 92 x 135 |          | 3 700 | 1      |     |                                   |          |  |       |   |
|                  |        |        | A-19-1 | A      | 92 x 135 |          | 3 700 | 1      |     |                                   |          |  |       |   |
|                  |        |        | A-19-2 | A      | 92 x 135 |          | 3 700 | 1      |     |                                   |          |  |       |   |
|                  |        |        | B-19-3 | B      | 92 x 135 |          | 3 700 | 1      |     |                                   |          |  |       |   |
|                  |        |        | B-19-2 | B      | 92 x 135 |          | 3 554 | 1      |     |                                   |          |  |       |   |
| F-8-1            | F-9-1  | F-10-1 | F-11-1 | F-12-1 | F        | 92 x 135 |       | 3 300  | 9   | 92-full<br><i>с одной стороны</i> |          |  |       |   |
|                  | F-13-1 | F-14-1 | F-15-1 | F-16-1 |          |          |       |        |     |                                   |          |  |       |   |
|                  |        |        | B-17-1 | D-17-1 | B, D     | 92 x 135 |       | 3 174  | 2   | 92-full                           |          |  |       |   |
|                  |        |        |        | 7-18-1 | 7        | 92 x 135 |       | 3 156  | 1   |                                   |          |  |       |   |
|                  |        |        |        | 2-1-2  | 2        | 92 x 135 |       | 3 010  | 1   |                                   |          |  |       |   |
|                  |        |        |        | 2-17-2 | 2        | 92 x 135 |       | 3 010  | 1   |                                   |          |  |       |   |
|                  |        | B-8-1  | D-8-1  |        | B, D     | 92 x 135 |       | 2 874  | 2   |                                   |          |  |       |   |
| 3-2-2            | 4-25-2 | 6-1-2  | 6-17-2 |        | 3, 4, 6  | 92 x 135 |       | 2 864  | 4   |                                   |          |  |       |   |



| Mont list №   | Wall    | B(mm)    | H(mm)    | L (mm) | St.                               | Name                              |
|---|---------|----------|----------|--------|-----------------------------------|-----------------------------------|
| <i>Без шипов</i>  | 1-18-2  | 1        | 92 x 135 | 2 864  | 1                                 | 92-full                           |
|   | 2-23-2  | 2        | 92 x 135 | 2 864  | 1                                 |                                   |
| B-2-1 D-2-1   | B, D    | 92 x 135 | 2 774    | 2      |                                   |                                   |
| B-18-1 D-18-1   | B, D    | 93 x 135 | 2 728    | 2      |                                   |                                   |
| B-19-1  | B       | 93 x 135 | 2 728    | 1      |                                   |                                   |
| A-2-1 A-4-1 A-6-1 A-18-1<br>F-2-1 F-4-1 F-6-1 F-18-1  | A, F    | 92 x 135 | 2 769    | 8      |                                   | 92-full<br><i>с одной стороны</i> |
| F-8-2 F-9-2 F-10-2 F-11-2 F-12-2<br>F-13-2 F-14-2 F-15-2 F-16-2   | F       | 92 x 135 | 2 600    | 9      |                                   |                                   |
| 1-13-1 1-14-1 1-15-1 1-16-1   | 1       | 92 x 135 | 2 562    | 4      |                                   |                                   |
| B-2-3 B-3-4 B-4-4 B-5-4 B-6-4<br>B-7-4 B-8-3 B-9-4 B-10-4 B-11-4<br>B-12-4 B-13-4 B-14-4 B-15-4 B-16-4  | B       | 92 x 135 | 2 174    | 15     |                                   | 92-full<br><i>с двух сторон</i>   |
| C-2-1 C-3-1 C-4-1 C-5-1 C-6-1<br>C-7-1 C-8-1 C-9-1 C-10-1 C-11-1<br>C-12-1 C-13-1 C-14-1 C-15-1 C-16-1<br>C-17-1 C-18-1   | C       | 92 x 135 | 2 174    | 17     |                                   |                                   |
| C-19-1  | B       | 92 x 135 | 2 174    | 1      |                                   |                                   |
| B-18-3 D-18-3 F-3-2<br>F-5-2 F-7-2 F-17-2   | B, D, F | 92 x 135 | 2 028    | 6      |                                   |                                   |
| F-19-2  | F       | 92 x 135 | 2 028    | 1      |                                   |                                   |
| D-2-3 D-3-4 D-4-4 D-5-4 D-6-4<br>D-7-4 D-8-3 D-9-4 D-10-4 D-11-4<br>D-12-4 D-13-4 D-14-4 D-15-4 D-16-4  | D       | 92 x 135 | 1743     | 15     |                                   | 92-full<br><i>с двух сторон</i>   |
| 2-18-2  | 2       | 92 x 135 | 1 658    | 1      | 92-full                           |                                   |
| 6-8-4 6-9-4 6-10-4 6-11-4 6-12-4<br>6-13-4 6-14-4 6-15-4 6-16-4   | 6       | 92 x 135 | 1 656    | 9      | 92-full<br><i>с двух сторон</i>   |                                   |
| 6-8-2 6-9-2 6-10-2 6-11-2 6-12-2<br>6-13-2 6-14-2 6-15-2 6-16-2   | 6       | 92 x 135 | 1494     | 9      |                                   |                                   |
| D-16-3  | D       | 93 x 135 | 1222     | 1      | 92-full<br><i>с одной стороны</i> |                                   |
| 6-8-1 6-9-1 6-10-1 6-11-1 6-12-1<br>6-13-1 6-14-1 6-15-1 6-16-1 6-8-5<br>6-9-5 6-10-5 6-11-5 6-12-5 6-13-5<br>6-14-5 6-15-5 6-16-5 A-8-2 A-9-2<br>A-10-2 A-11-2 A-12-2 A-13-2 A-14-2<br>A-15-2 A-16-2 | 6, A    | 92 x 135 | 1020     | 27     |                                   |                                   |
| D-2-2 D-3-3 D-4-3 D-5-3 D-6-3<br>D-7-3 D-8-2 D-9-3 D-10-3 D-11-3<br>D-12-3 D-13-3 D-14-3 D-15-3   | D       | 92 x 135 | 1022     | 14     |                                   |                                   |
| B-16-3  | B       | 92 x 135 | 1 012    | 1      |                                   |                                   |
| 1-13-2 1-14-2 1-15-2 1-16-2   | 1       | 92 x 135 | 827      | 4      |                                   | 92-full <i>с двух сторон</i>      |
| B-2-2 B-3-3 B-4-3 B-5-3 B-6-3<br>B-7-3 B-8-2 B-9-3 B-10-3 B-11-3<br>B-12-3 B-13-3 B-14-3 B-15-3   | B       | 92 x 135 | 812      | 14     | 92-full<br><i>с одной стороны</i> |                                   |
| 1-13-3 1-14-3 1-15-3 1-16-3   | 1       | 92 x 135 | 761      | 4      | 92-full <i>с двух сторон</i>      |                                   |
| 3-1-1 3-1-2   | 3       | 92 x 135 | 692      | 2      | 92-full                           |                                   |
| 2-2-3 2-3-3 2-4-3 2-5-3 2-6-3<br>2-7-3 2-8-3 2-9-3 2-10-3 2-11-3<br>2-12-3 2-13-3 2-14-3 2-15-3 2-16-3  | 2       | 92 x 135 | 652      | 15     | 92-full<br><i>с 1ой стороны</i>   |                                   |
| B-16-2 D-16-2   | B, D    | 92 x 135 | 592      | 2      | 92-full                           |                                   |
| B-7-1 D-7-1   |         |          | 492      | 2      |                                   |                                   |
| 2-2-2 2-3-2 2-4-2 2-5-2 2-6-2<br>2-7-2 2-8-2 2-9-2 2-10-2 2-11-2<br>2-12-2 2-13-2 2-14-2 2-15-2 2-16-2  | 2       | 92 x 135 | 492      | 15     | 92-full<br><i>с двух сторон</i>   |                                   |
| B-3-1 B-3-2 B-7-2 D-3-1 D-3-2<br>D-7-2  | B, D    | 92 x 135 | 392      | 6      | 92-full                           |                                   |
| D-2-4 D-3-5 D-4-5 D-5-5 D-6-5<br>D-7-5 D-8-4 D-9-5 D-10-5 D-11-5 D-12-5<br>D-13-5 D-14-5 D-15-5 D-16-5  | D       | 92 x 135 | 392      | 15     | 92-full<br><i>с 1ой стороны</i>   |                                   |
| 2-19-1 2-20-1 2-19-2 2-20-2 2-19-3<br>2-20-3 2-19-4 2-20-4 4-19-1 4-20-1<br>4-21-1 4-22-1 4-23-1 4-19-2 4-20-2<br>4-21-2 4-22-2 4-23-2 4-24-2 5-19-1  | 2, 4, 5 | 92 x 135 | 292      | 20     | 92-full                           |                                   |

| Mont list № |        |        |        |        | Wall      | B(mm)    | H(mm) | L (mm) | St.                             | Name      |
|-------------|--------|--------|--------|--------|-----------|----------|-------|--------|---------------------------------|-----------|
| 5-20-1      | 5-19-2 | 5-20-2 | 5-21-1 | 5-1-2  | 2, 4, 5   | 92 x 135 | 292   | 292    | 15                              | 92-full   |
| 5-2-2       | 5-3-2  | 5-4-2  | 5-5-2  | 5-6-2  |           |          |       |        |                                 |           |
| 5-7-2       | 5-8-2  | 5-9-2  | 5-10-2 | 5-11-2 |           |          |       |        |                                 |           |
| 5-12-2      | 5-13-2 | 5-14-2 | 5-15-2 | 5-16-2 | 5, 7, B,D | 92 x 135 | 292   | 50     | 92-full                         |           |
| 5-17-2      | 5-18-2 | 5-19-3 | 5-20-3 | 7-1-1  |           |          |       |        |                                 |           |
| 7-2-1       | 7-3-1  | 7-4-1  | 7-5-1  | 7-6-1  |           |          |       |        |                                 |           |
| 7-7-1       | 7-8-1  | 7-9-1  | 7-10-1 | 7-11-1 |           |          |       |        |                                 |           |
| 7-12-1      | 7-13-1 | 7-14-1 | 7-15-1 | 7-16-1 |           |          |       |        |                                 |           |
| 7-17-1      | 7-1-2  | 7-2-2  | 7-3-2  | 7-4-2  |           |          |       |        |                                 |           |
| 7-5-2       | 7-6-2  | 7-7-2  | 7-8-2  | 7-9-2  |           |          |       |        |                                 |           |
| 7-10-2      | 7-11-2 | 7-12-2 | 7-13-2 | 7-14-2 |           |          |       |        |                                 |           |
| 7-15-2      | 7-16-2 | 7-17-2 | B-4-1  | B-5-1  |           |          |       |        |                                 |           |
| B-6-1       | B-4-2  | B-5-2  | B-6-2  | B-9-1  |           |          |       |        |                                 |           |
| B-10-1      | B-11-1 | B-12-1 | B-13-1 | B-14-1 | B, D      | 92 x 135 | 292   | 35     | 92-full                         |           |
| B-15-1      | B-16-1 | B-9-2  | B-10-2 | B-11-2 |           |          |       |        |                                 |           |
| B-12-2      | B-13-2 | B-14-2 | B-15-2 | D-4-1  |           |          |       |        |                                 |           |
| D-5-1       | D-6-1  | D-4-2  | D-5-2  | D-6-2  |           |          |       |        |                                 |           |
| D-9-1       | D-10-1 | D-11-1 | D-12-1 | D-13-1 |           |          |       |        |                                 |           |
| D-14-1      | D-15-1 | D-16-1 | D-9-2  | D-10-2 |           |          |       |        |                                 |           |
| D-11-2      | D-12-2 | D-13-2 | D-14-2 | D-15-2 |           |          |       |        |                                 |           |
| 6-8-3       | 6-9-3  | 6-10-3 | 6-11-3 | 6-12-3 | 6         | 92 x 135 | 200   | 9      | 92-full<br><i>с двух сторон</i> |           |
|             | 6-13-3 | 6-14-3 | 6-15-3 | 6-16-3 |           |          |       |        |                                 |           |
|             |        |        | F-1-1  | F      | 92 x 67   | 5 372    | 4 777 | 3 846  | 1                               | Половинки |
|             |        |        | D-1-2  | D      |           |          |       |        |                                 |           |
|             |        |        | B-1-2  | B      |           |          |       |        |                                 |           |
|             |        |        | A-1-1  | A      |           |          |       |        |                                 |           |
|             |        |        | A-1-2  | A      |           |          |       |        |                                 |           |
|             |        | B-1-1  | D-1-1  | B, D   |           |          |       |        |                                 |           |
|             |        |        | C-1-1  | C      |           |          |       |        |                                 |           |
|             |        |        | F-1-2  | F      |           |          |       |        |                                 |           |
|             |        | A-22-1 | B-22-1 | A, B   | 92 x 135  | 5 738    | 5 372 | 5 012  | 2                               | Apex      |
|             |        |        | D-22-1 | D      |           |          |       |        |                                 |           |
|             |        |        | F-22-1 | F      |           |          |       |        |                                 |           |
|             |        |        | B-20-1 | B      | 92 x 135  | 5 372    | 5 012 | 4 796  | 1                               | Apex      |
|             |        |        | D-20-1 | D      |           |          |       |        |                                 |           |
|             |        |        | F-21-1 | F      | 92 x 135  | 4 631    | 4 271 | 3 854  | 2                               | Apex      |
|             |        | A-23-1 | B-23-1 | A, B   |           |          |       |        |                                 |           |
|             |        | D-23-1 | F-23-1 | D, F   | 92 x 135  | 4 631    | 4 271 | 3 854  | 2                               | Apex      |
|             |        |        | A-20-2 | A      |           |          |       |        |                                 |           |
|             |        |        | F-20-2 | F      | 92 x 135  | 4 271    | 3 854 | 3 340  | 1                               | Apex      |
|             |        |        | D-21-2 | D      |           |          |       |        |                                 |           |
|             |        | A-24-1 | B-24-1 | A, B   | 92 x 135  | 3 854    | 3 156 | 2 914  | 3                               | Apex      |
|             |        |        | D-24-1 | D      |           |          |       |        |                                 |           |
|             |        |        | F-24-1 | F      |           |          |       |        |                                 |           |
|             |        | A-21-2 | B-21-1 | A, B   | 92 x 135  | 3 340    | 3 156 | 2 914  | 2                               | Apex      |
|             |        |        | A-21-1 | A      |           |          |       |        |                                 |           |
|             |        |        | B-21-2 | B      |           |          |       |        |                                 |           |
|             |        |        | 7-19-1 | 7      | 92 x 135  | 2 914    | 2 884 | 2 769  | 1                               | Apex      |
|             |        | A-25-1 | B-25-1 | D-25-1 |           |          |       |        |                                 |           |
|             |        |        | F-25-1 | F      | 92 x 135  | 2 884    | 2 769 | 2 409  | 1                               | Apex      |
|             |        |        | 7-20-1 | 7      |           |          |       |        |                                 |           |
|             |        | A-20-1 | F-20-1 | A, F   | 92 x 135  | 2 409    | 2 174 | 2 028  | 2                               | Apex      |
|             |        |        | D-21-1 | D      |           |          |       |        |                                 |           |
|             |        |        | C-20-1 | C      |           |          |       |        |                                 |           |
|             |        | B-20-2 | D-20-2 | B, D   | 92 x 135  | 1 972    | 1 942 | 1 814  | 1                               | Apex      |
|             |        | A-26-1 | B-26-1 | D-26-1 |           |          |       |        |                                 |           |
|             |        |        | F-26-1 | F      | 92 x 135  | 1 942    | 1 814 | 1 668  | 1                               | Apex      |
|             |        |        | 7-21-1 | 7      |           |          |       |        |                                 |           |
|             |        |        | C-21-1 | C      | 92 x 135  | 1 668    | 1 342 | 1 030  | 4                               | Apex      |
|             |        |        | F-21-2 | F      |           |          |       |        |                                 |           |
|             |        |        | C-22-1 | C      | 92 x 135  | 1 000    | 872   | 402    | 1                               | Apex      |
|             |        | A-27-1 | B-27-1 | D-27-1 |           |          |       |        |                                 |           |
|             |        |        | F-27-1 | F      | 92 x 135  | 1 000    | 872   | 402    | 1                               | Apex      |
|             |        |        | 7-22-1 | 7      |           |          |       |        |                                 |           |
|             |        |        | C-23-1 | C      | 92 x 135  | 872      | 402   | 402    | 1                               | Apex      |
|             |        |        | C-24-1 | C      |           |          |       |        |                                 |           |

| Mont list №                | Name                 | B(mm)       | H(mm)       | L (mm) | St.   | Name                 |   |                 |
|----------------------------|----------------------|-------------|-------------|--------|-------|----------------------|---|-----------------|
| 1                          | Foundation           | 120         | 95          | 6 000  | 4     | foundation beams     |   |                 |
| 1\1                        |                      | 120         | 95          | 3 960  | 4     |                      |   |                 |
| 1\2                        |                      | 120         | 95          | 3 600  | 4     |                      |   |                 |
| 1\3                        |                      | 120         | 95          | 2 716  | 1     |                      |   |                 |
| 1\4                        |                      | 120         | 95          | 2 382  | 2     |                      |   |                 |
| 2                          | Foundation           | 40          | 95          | 6 000  | 13    | foundation beams     |   |                 |
| 2\1                        |                      | 40          | 95          | 3 960  | 13    |                      |   |                 |
| 2\2                        |                      | 40          | 95          | 2 716  | 5     |                      |   |                 |
| 3                          | Roof                 | 45          | 145         | 4 200  | 47    | rafters              |   |                 |
| 3\1                        |                      | 45          | 145         | 3 100  | 2     |                      |   |                 |
| 3\2                        |                      | 45          | 145         | 1 942  | 14    |                      |   |                 |
| 4                          | Roof                 | 45          | 145         | 24 m   |       | between rafters      |   |                 |
| 5                          | Roof                 | 58          | 145         | 4 564  | 1     | ridge beam           |   |                 |
| 6                          | Roof                 | 28          | 135         | 936 m  |       | roof boards          |   |                 |
| 7                          | Roof                 | 20          | 145         | 4 300  | 8     | end boards           |   |                 |
| 7\1                        |                      | 20          | 145         | 2 050  | 4     |                      |   |                 |
| 8                          | Roof                 | 20          | 95          | 360 m  |       | lining               |   |                 |
| 9                          | Floor                | 28          | 135         | 4 137  | 11    | floor boards         |   |                 |
| 9\1                        |                      | 28          | 135         | 3 458  | 55    |                      |   |                 |
| 9\2                        |                      | 28          | 135         | 3 025  | 12    |                      |   |                 |
| 9\3                        |                      | 28          | 135         | 2 527  | 28    |                      |   |                 |
| 9\4                        |                      | 28          | 135         | 2 507  | 27    |                      |   |                 |
| 9\5                        |                      | 28          | 135         | 2 105  | 12    |                      |   |                 |
| 9\6                        |                      | 28          | 135         | 1 786  | 48    |                      |   |                 |
| 9\7                        |                      | 28          | 135         | 993    | 11    |                      |   |                 |
| 10                         | Floor                | 19          | 90          | 2 380  | 30    | terrace boards       |   |                 |
| 11, 11\1, 11\2, 11\3, 11\4 | Ceiling              | 19          | 85          | 864 m  |       | ceiling boards       |   |                 |
| 12                         | Ceiling              | 34          | 95          | 3 530  | 32    | ceiling beams        |   |                 |
| 12\1                       |                      | 34          | 95          | 2 772  | 19    |                      |   |                 |
| 13                         | Ceiling plinth       | 20          | 45          | 6 000  | 18    | Ceiling plinth       |   |                 |
| 14                         | Floor plinth         | 20          | 45          | 96 m   |       | Floor plinth         |   |                 |
| 15                         | Door fix             | 30          | 30          | 2 025  | 14    | Door fix.elem        |   |                 |
| 16                         | Window fix.element   | 30          | 30          | 1 215  | 10    | Window fix.element   |   |                 |
| 16\1                       |                      | 30          | 30          | 540    | 4     |                      |   |                 |
| W-1 18                     | WINDOWS<br>PLATHBAND | 20          | 95          | 1 680  | 8     | windows<br>plathband |   |                 |
| W-1 18\1                   |                      | 20          | 95          | 1 325  | 16    |                      |   |                 |
| W-1 18\2                   |                      | 20          | 95          | 1 430  | 8     |                      |   |                 |
| W-2 18\3                   |                      | 20          | 95          | 1 130  | 2     |                      |   |                 |
| W-2 18\4                   |                      | 20          | 95          | 1 325  | 4     |                      |   |                 |
| W-2 18\5                   |                      | 20          | 95          | 880    | 2     |                      |   |                 |
| W-3 18\6                   |                      | 20          | 95          | 780    | 4     |                      |   |                 |
| W-3 18\7                   |                      | 20          | 95          | 675    | 8     |                      |   |                 |
| W-3 18\8                   | 20                   | 95          | 530         | 4      |       |                      |   |                 |
| D-1 19                     | DOORS<br>PLATHBAND   | 20          | 95          | 1 260  | 2     | doors<br>plathband   |   |                 |
| D-1 19\1                   |                      | 20          | 95          | 2 070  | 4     |                      |   |                 |
| D-2 19\2                   |                      | 20          | 95          | 1 110  | 2     |                      |   |                 |
| D-2 19\3                   |                      | 20          | 95          | 2 070  | 4     |                      |   |                 |
| D-3 19\4                   |                      | 20          | 95          | 1 060  | 6     |                      |   |                 |
| D-3 19\5                   |                      | 20          | 95          | 2 070  | 12    |                      |   |                 |
| D-4 19\6                   |                      | 20          | 95          | 960    | 4     |                      |   |                 |
| D-5 19\7                   |                      | 20          | 95          | 2 070  | 8     |                      |   |                 |
| 20                         |                      | fix.element | 19          | 22     | 6 000 |                      | 6 | Window fix.elem |
| D-1                        |                      | DOORS       | 1050 x 2050 |        |       |                      | 1 | doors           |
| D-2                        | 900 x 2050           |             |             |        | 1     |                      |   |                 |
| D-3                        | 850 x 2050           |             |             |        | 3     |                      |   |                 |
| D-4                        | 750 x 2050           |             |             |        | 2     |                      |   |                 |
| W-1                        | WINDOWS              | 1470 x 1270 |             |        | 4     | windows              |   |                 |
| W-2                        |                      | 920 x 1270  |             |        | 1     |                      |   |                 |
| W-3                        |                      | 570 x 620   |             |        | 2     |                      |   |                 |