

Name

Gunnar 300x400+450_44

Zeichnung/Drawing

3D

Profil/Profile

4.4x13.5

Datum/Date

07.10.2019

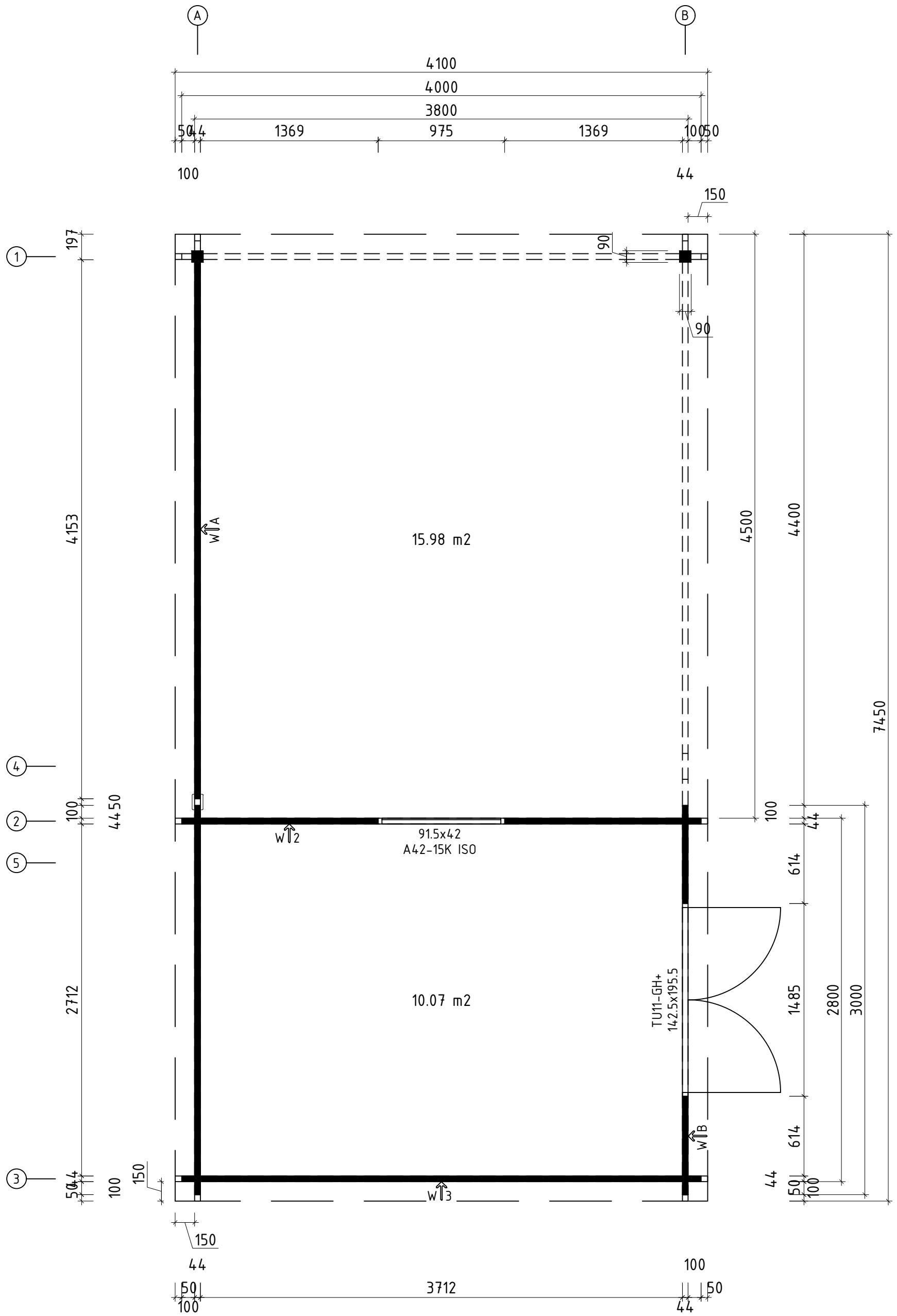

Name	Gunnar 300x400+450_44		
Zeichnung/Drawing	Grundplan, Plan		
Profil/Profile	4.4x13.5	Datum/Date	07.10.2019

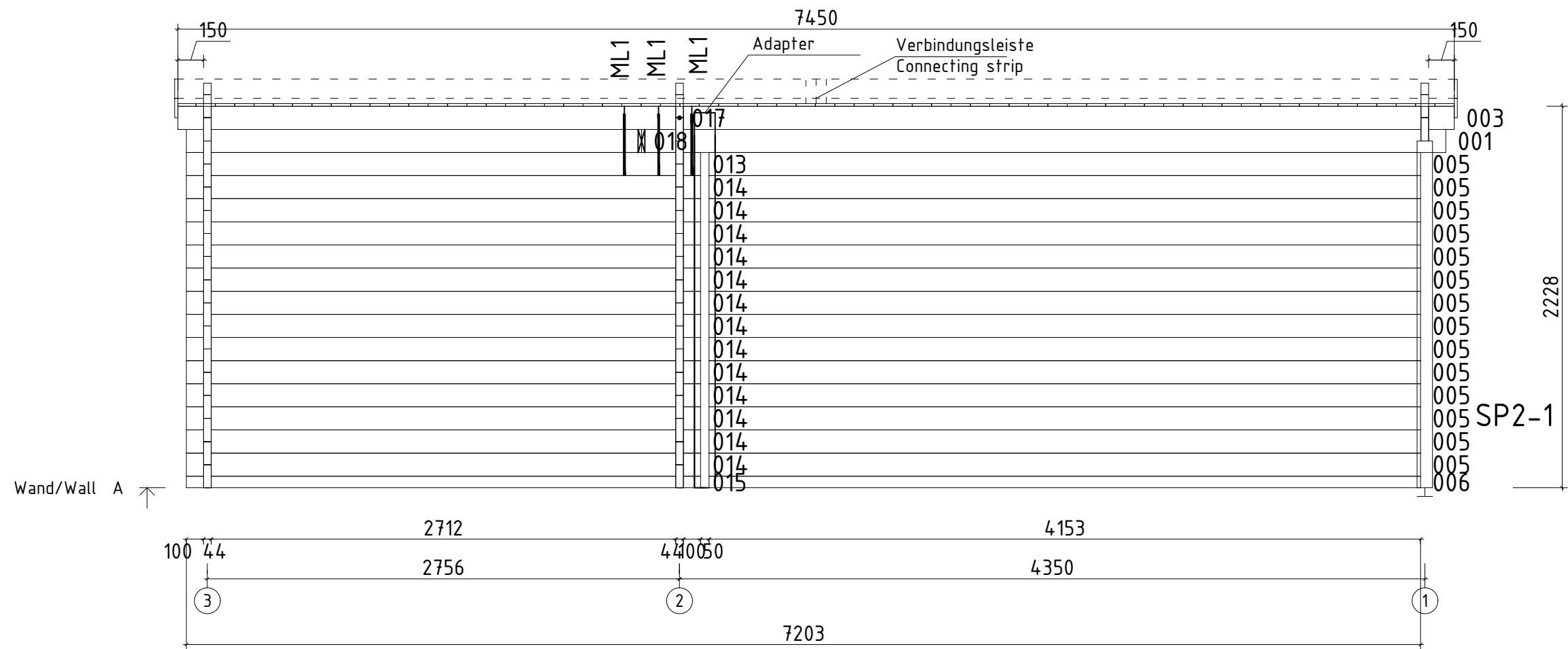

Name	Gunnar 300x400+450_44		
Zeichnung/Drawing	WAND/WALL A		
Profil/Profile	4.4x13.5	Datum/Date	07.10.2019

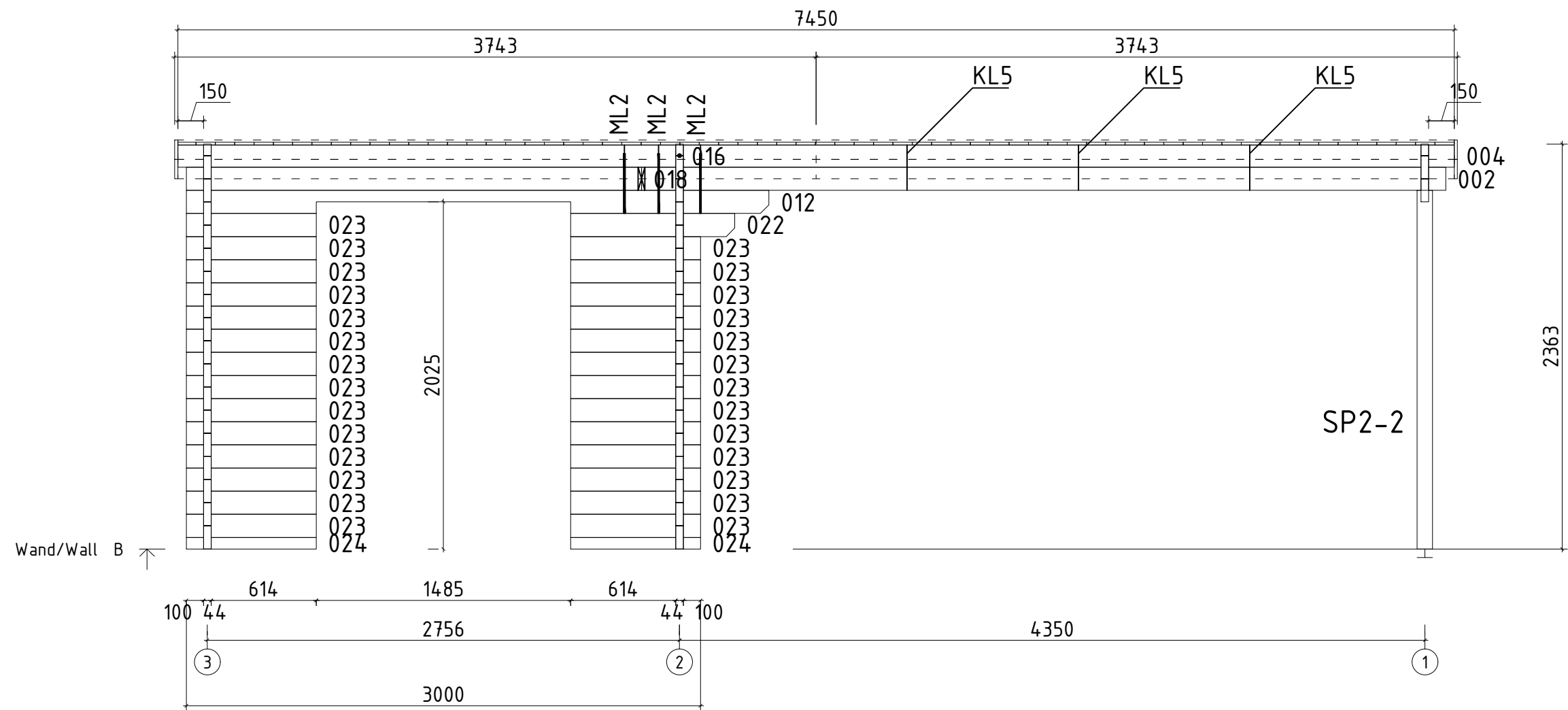

Name	Gunnar 300x400+450_44		
Zeichnung/Drawing	WAND/WALL B		
Profil/Profile	4.4x13.5	Datum/Date	07.10.2019

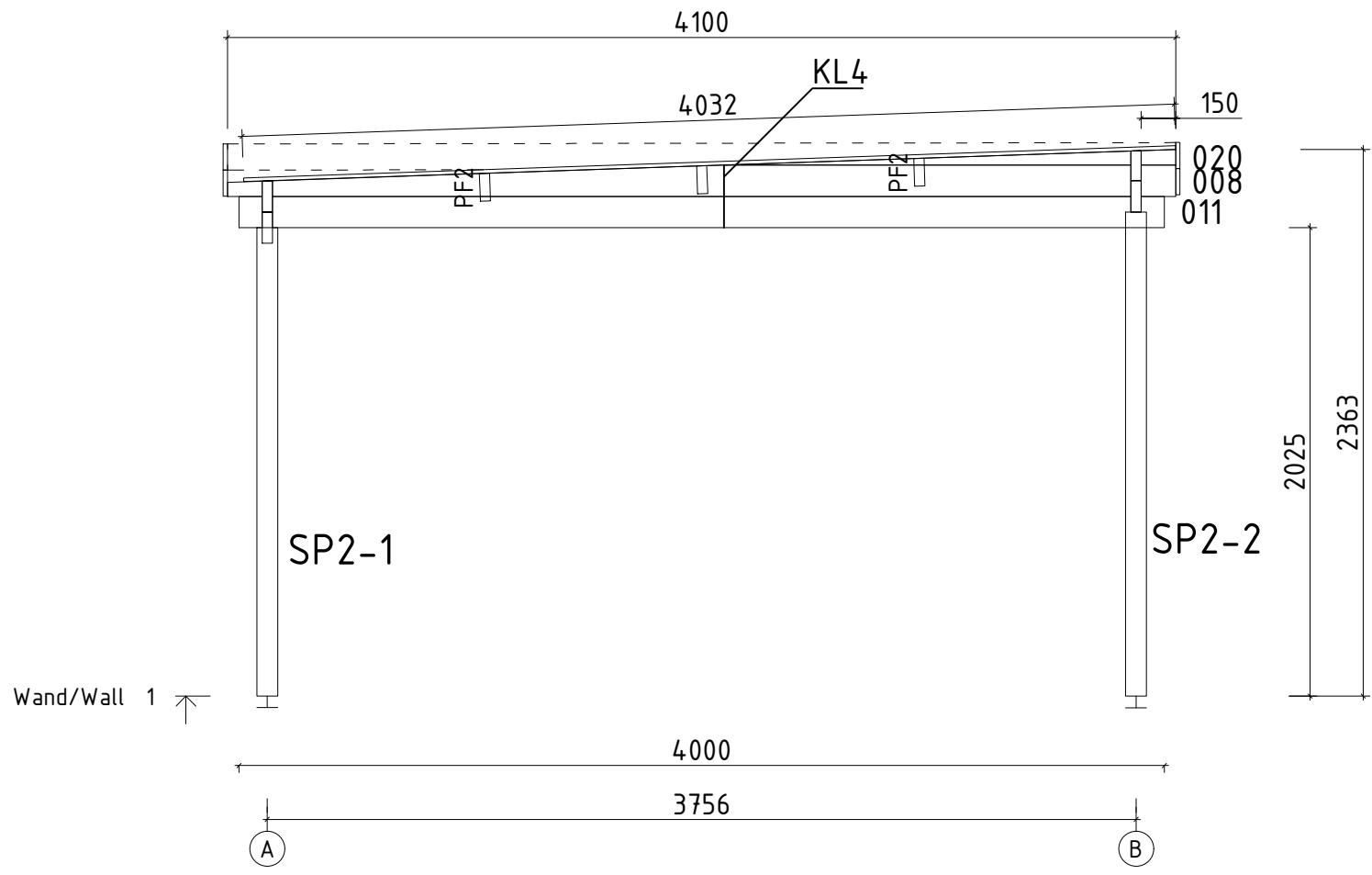

Name	Gunnar 300x400+450_44		
Zeichnung/Drawing	WAND/WALL 1		
Profil/Profile	4.4x13.5	Datum/Date	07.10.2019

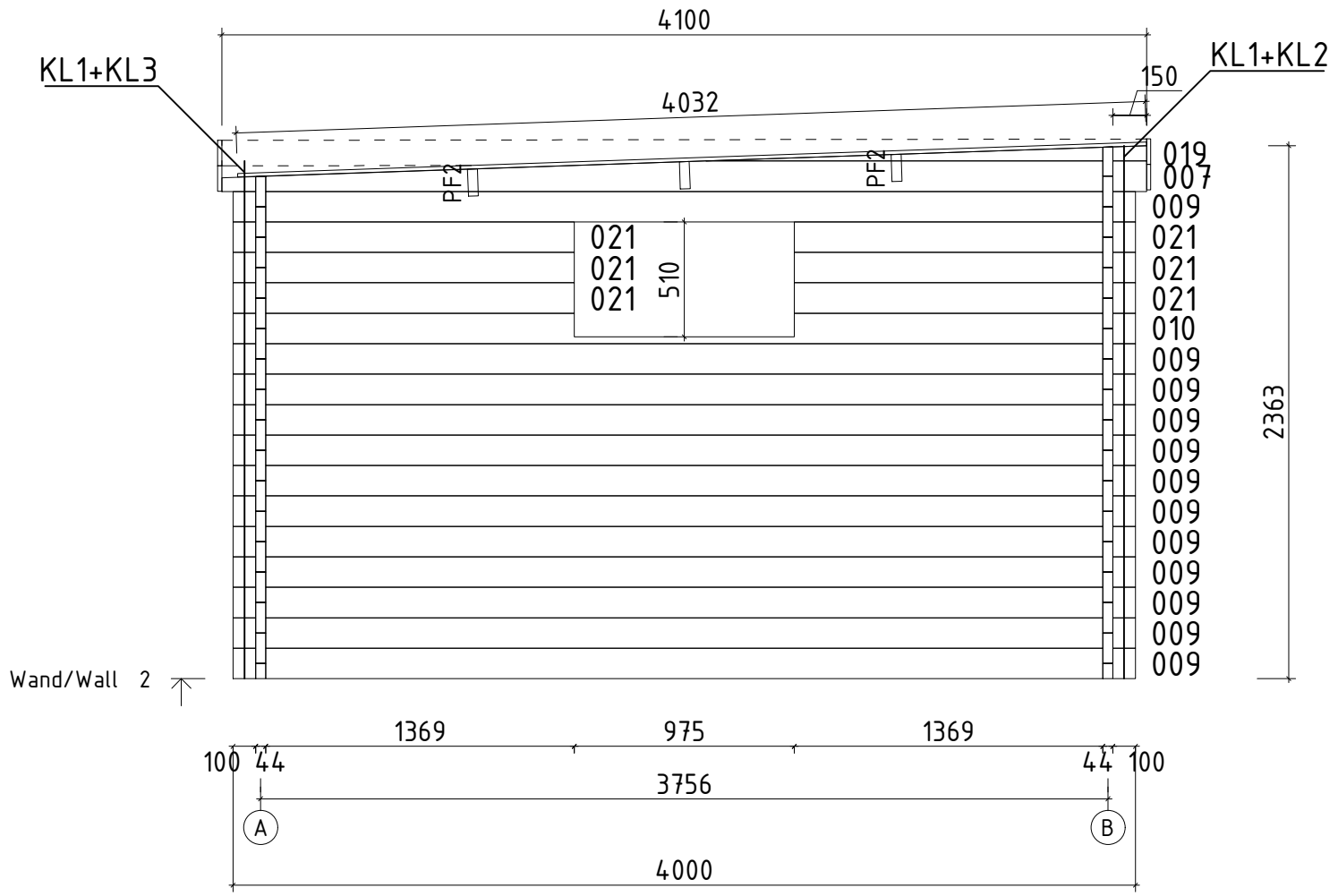

Name	Gunnar 300x400+450_44		
Zeichnung/Drawing	WAND/WALL 2		
Profil/Profile	4.4x13.5	Datum/Date	07.10.2019

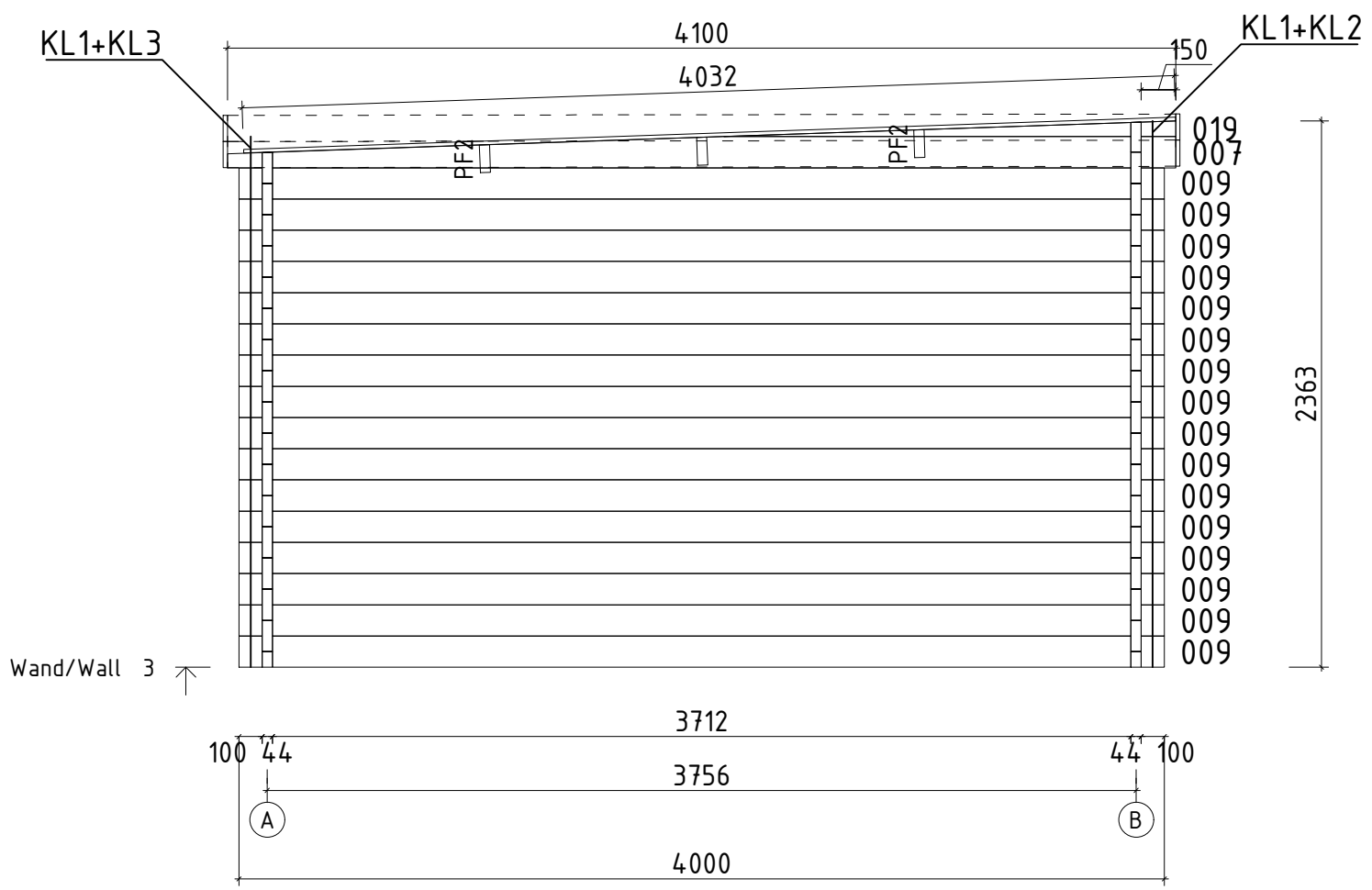

Name	Gunnar 300x400+450_44		
Zeichnung/Drawing	WAND/WALL 3		
Profil/Profile	4.4x13.5	Datum/Date	07.10.2019

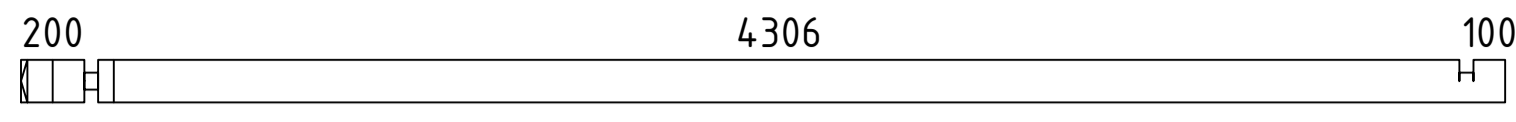
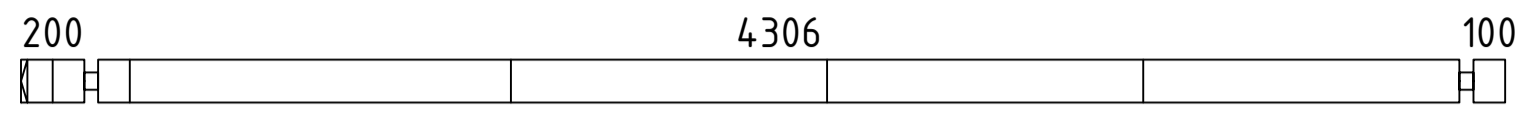
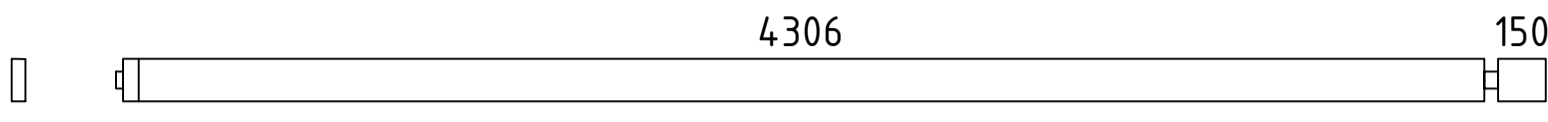
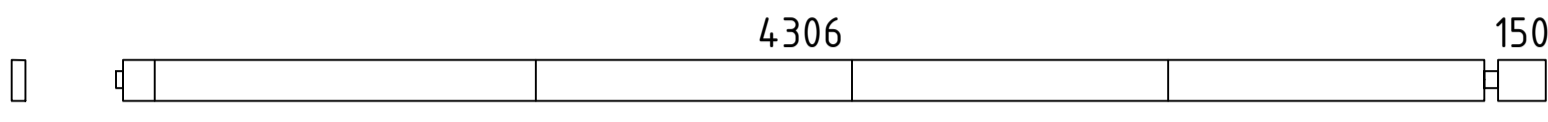
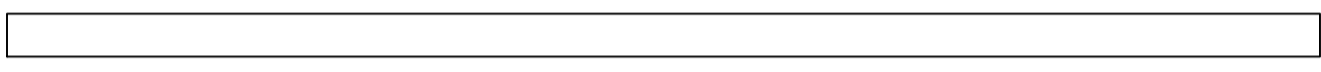
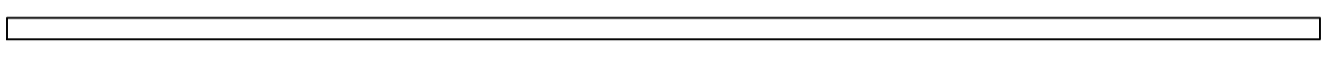
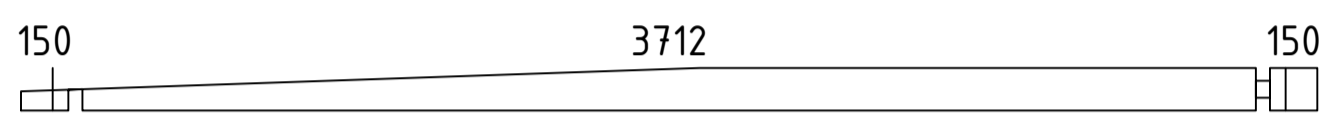
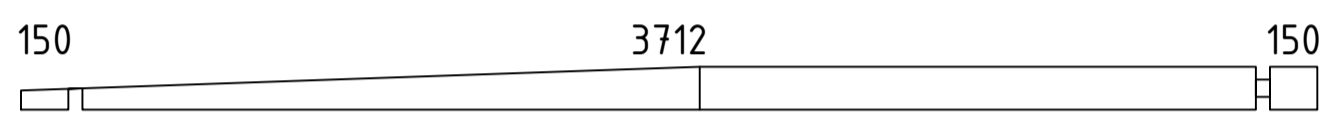
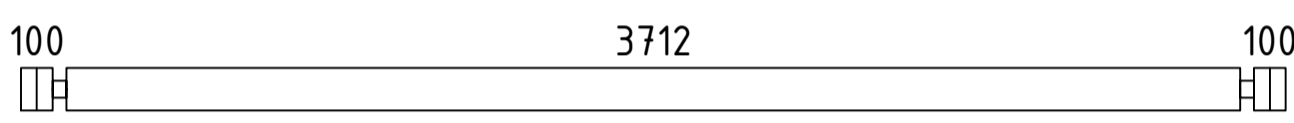
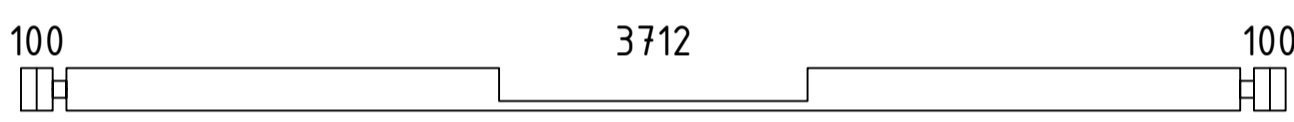
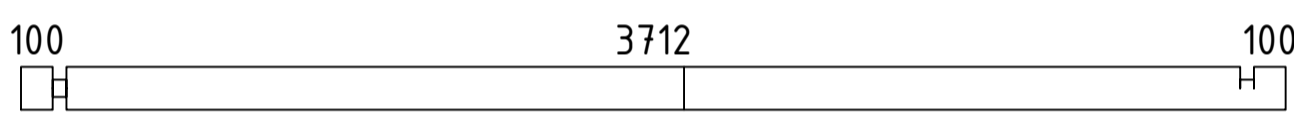
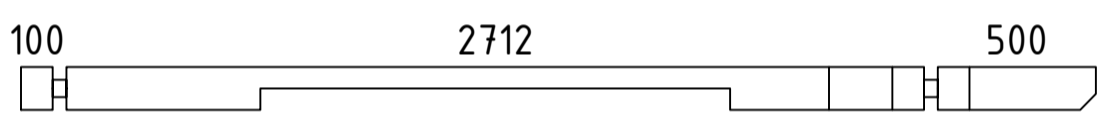
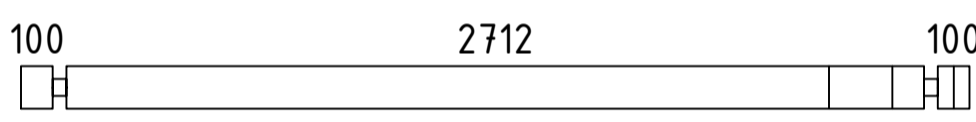
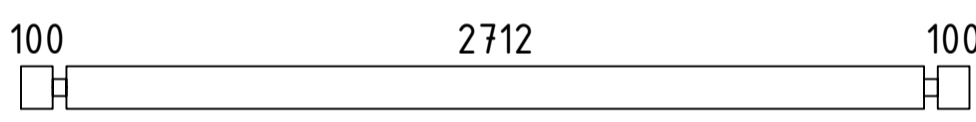
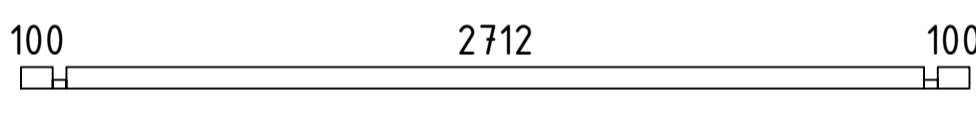
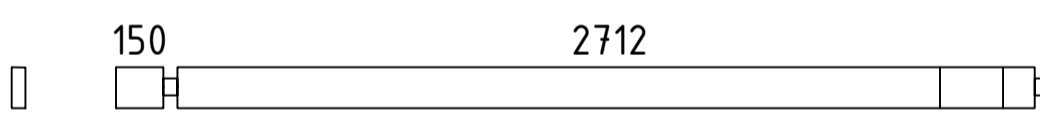
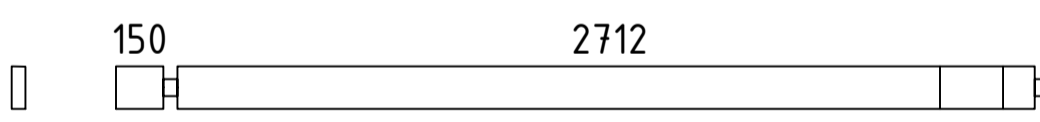
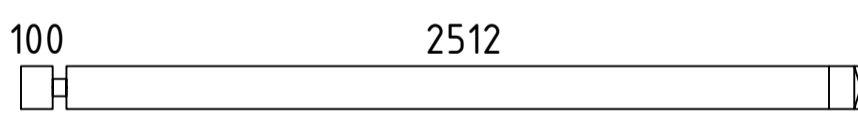
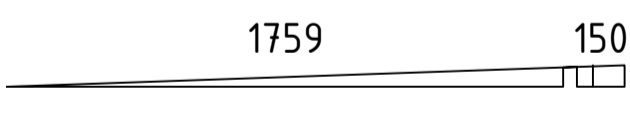
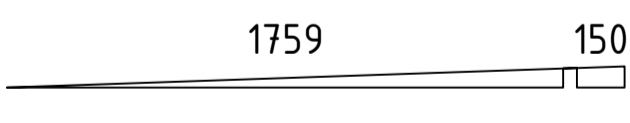
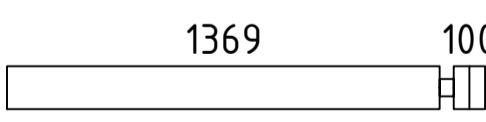
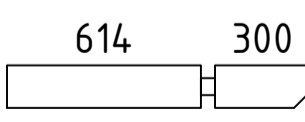
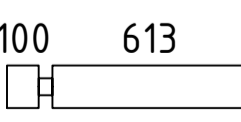
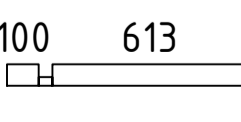
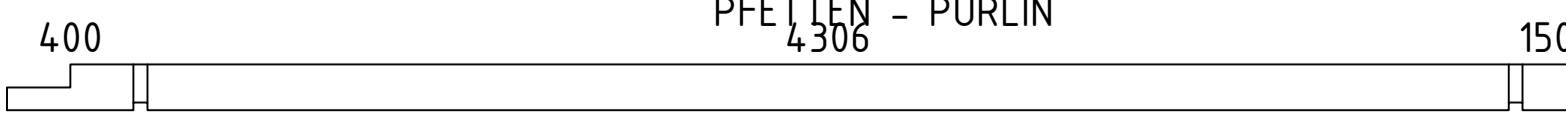
Pos	Teileliste/Specification Gunnar 300x400+450_44	Stck. Pcs.	Profil Profile (mm)	Länge Length (mm)
001		1	44x135	4694
002		1	44x135	4694
003		1	44x135	4522
004		1	44x130	4522
005		14	44x135	4153
006		1	44x68	4153
007		2	44x135	4100
008		1	44x135	4100
009		28	44x135	4000
010		1	44x135	4000
011		1	44x135	4000
012		1	44x135	3400
013		1	44x135	3000
014		13	44x135	3000
015		1	44x68	3000
016		1	44x130	2928
017		1	44x135	2928
018		2	44x135	2656
019		2	44x68	1953
020		1	44x68	1953
021		6	44x135	1513
022		1	44x135	958
023		27	44x135	758
024		2	44x68	758
PF4		1	44x145	4944

Pos	Teileliste/Specification Gunnar 300x400+450_44		Stck. Pcs.	Profil Profile (mm)	Länge Length (mm)
PF2			2	44x145	4200
PF1			2	44x145	3450
PF3			1	44x145	2706
	DACHBRETTER - ROOF BOARDS		66+1	113x16	4032
BB-1	DACHBLENDEN- Blendenbretter - PARAPET-boards		4+4	18x113	3743
BB-2	DACHBLENDEN- Blendenbretter - PARAPET-boards		2+2	18x113	4100
VL-1	DACHBLENDEN- Verbindungsleisten - PARAPET- connecting strips		2	18x120	215
BS-1	DACHBLENDEN- Blendenstützen - PARAPET- Parapet support 44x65		10	44x65	150
MB-1	DACHBLENDEN- Montagebrett - PARAPET- mounting board 215mm		22	58x18	215
T06-1	TRAUFENLEISTEN - EAVES STRIPS 18x40		✓	18x40	15,0 lfm/rm
TP90-1	STÜTZPFOSTE - SUPPORT POST 90x90		✓	90x90	2275
TP90-2	STÜTZPFOSTE - SUPPORT POST 90x90		✓	90x90	2342
A44-1	ADAPTER 44	Obere seite Upper edge	✓	80x120	2190
ML1	Metallstange - Metal bar		3	D10	360
ML2	Metallstange - Metal bar		3	D10	350
SH	SCHLAGHÖLZER - MOUNTING PIECES		3		
HK2	HOLZ-KLOTZEN für verbinden der Wandbohlen - Wooden wedge for connecting the wall parts (122mm)		2		
VS	Verbindungsstreifen für verbinden der Wandbohlen - Connecting strip for connecting the wall parts		2		
SR21	SCHRAUBEN - SCREWS 6.0x140 (ASSY für Pfetten - for purlins)		6		
SR37	Schrauben - Screws 3.5x45 Fenster- und Türleisten - Window and Door strips Verbindungsstreifen - Connecting strips		52		
VP2	Verstellbare Pfostenstütze - Adjustable post support M16		2		
KL1	Gewindestange - Threaded Rod M8		4		2000
KL2	Gewindestange - Threaded Rod M8		2		393
KL3	Gewindestange - Threaded Rod M8		2		325
KL4	Gewindestange - Threaded Rod M8		1		270
Kood	Gunnar 300x400+450_44	Materjal	File	Leht	2/3

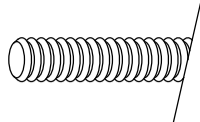
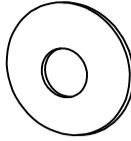
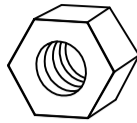
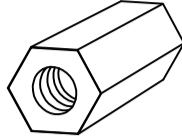
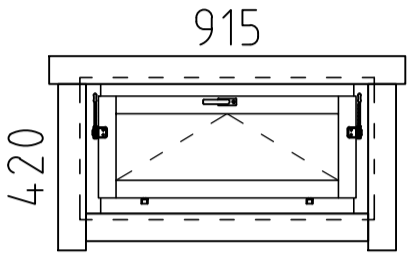
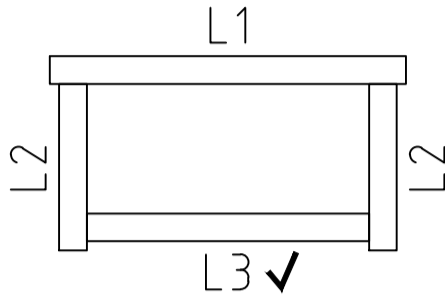
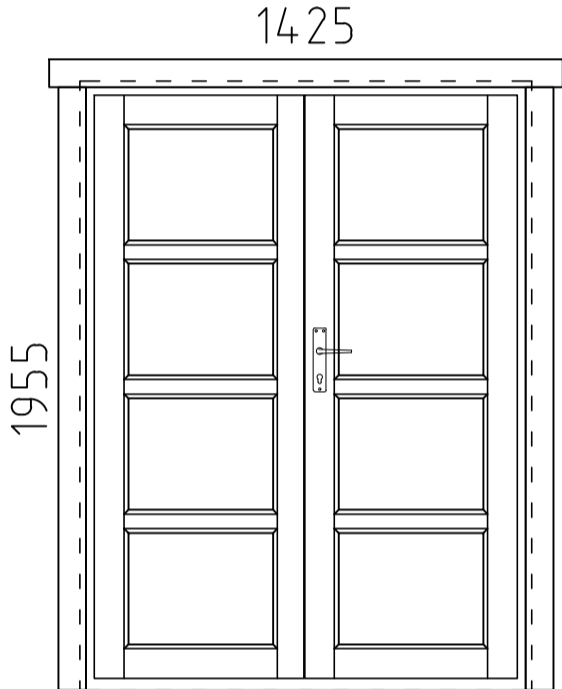
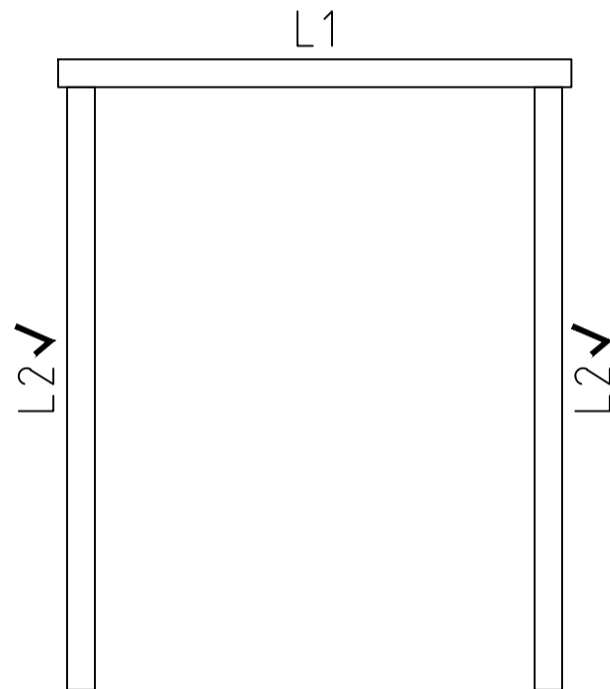
Pos	Teileliste/Specification Gunnar 300x400+450_44	Stck. Pcs.	Profil Profile (mm)	Länge Length (mm)												
KL5	Gewindestange - Threaded Rod M8 	3		265												
	Mutter - nut M8 U-Scheibe - washer Ø25  	16														
	Befestigungsmutter - fixing nut M8 	4														
	<p style="text-align: center;">FENSTER/WINDOW 915x420</p> <div style="display: flex; justify-content: space-around;"> <div data-bbox="468 676 737 845">  </div> <div data-bbox="764 676 1058 872">  </div> <div data-bbox="1108 647 1549 836"> <p>A42-15K ISO</p> <table border="0"> <tr><td>L1</td><td>18x90</td><td>L=1155mm</td><td>2x</td></tr> <tr><td>L2</td><td>18x90</td><td>L=540mm</td><td>4x</td></tr> <tr><td>L3</td><td>18x90</td><td>L=915mm</td><td>2x ✓</td></tr> </table> </div> </div>	L1	18x90	L=1155mm	2x	L2	18x90	L=540mm	4x	L3	18x90	L=915mm	2x ✓	1		
L1	18x90	L=1155mm	2x													
L2	18x90	L=540mm	4x													
L3	18x90	L=915mm	2x ✓													
	<p style="text-align: center;">TÜR/DOOR 1425x1955</p> <div style="display: flex; justify-content: space-around;"> <div data-bbox="357 1092 728 1546">  </div> <div data-bbox="764 1092 1167 1546">  </div> <div data-bbox="1213 1121 1654 1359"> <p>TU11-GH+</p> <table border="0"> <tr><td>L1</td><td>18x90</td><td>L=1665mm</td><td>2x</td></tr> <tr><td>L2</td><td>18x90</td><td>L=1955mm</td><td>4x ✓</td></tr> </table> <p>DIN rechts / right handed</p> </div> </div>	L1	18x90	L=1665mm	2x	L2	18x90	L=1955mm	4x ✓	1						
L1	18x90	L=1665mm	2x													
L2	18x90	L=1955mm	4x ✓													
✓ - Bitte selber anpassen (falls nötig)! / Cut into length on site (if needed)!																

Pärilinite ühendamine / Verbinden der Pfetten / Connecting purlins

1

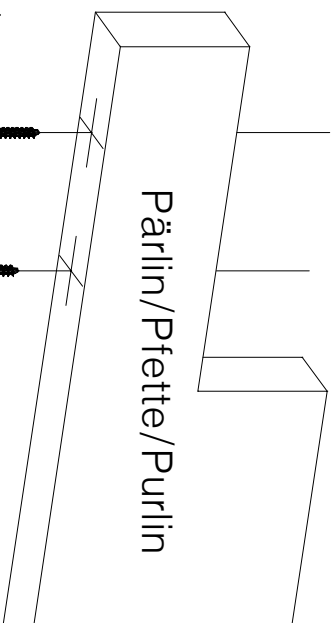
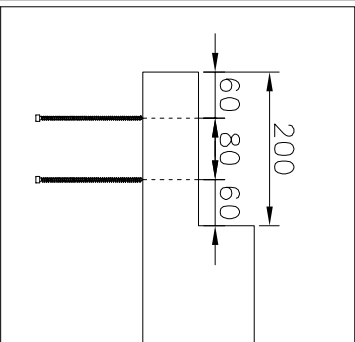

Märkige kruvide asukohad /
Markieren Sie die empfehlenden
Schraubenpositionen /
Mark the suggested positions
for screws

Kruvi/Schraube/
Screw 6x140

2

Keerake kruvid poole ulatuses sisse.
(Vaja läheb Assy AW30 või Torx T30 otsikut) ☆
Drehen Sie die Schrauben bis zur Hälfte
seiner Länge ein.

(Für diese Schrauben benötigen Sie einen
Assy AW30 oder Inrentorx T30
Schraubereinsatz) ☆

Turn the screws up
until the first half.

(These screws require Assy AW30
or Torx T30 driver bit) ☆

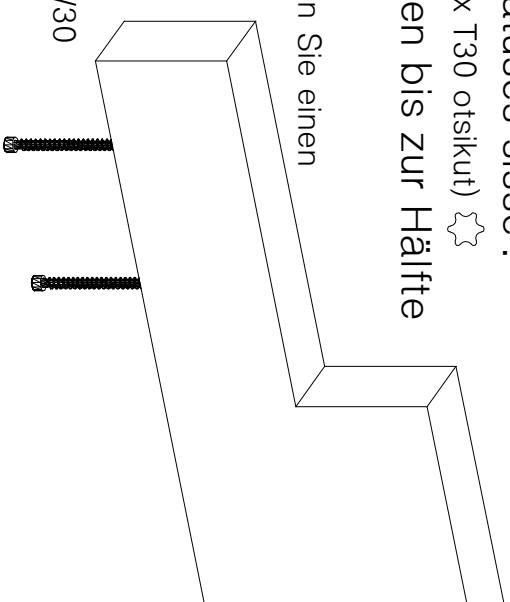

3

Hoja ühendatavad pärilnid tihedalt koos /
Setzen Sie die Enden der Balken zusammen /
Keep purlins tight together

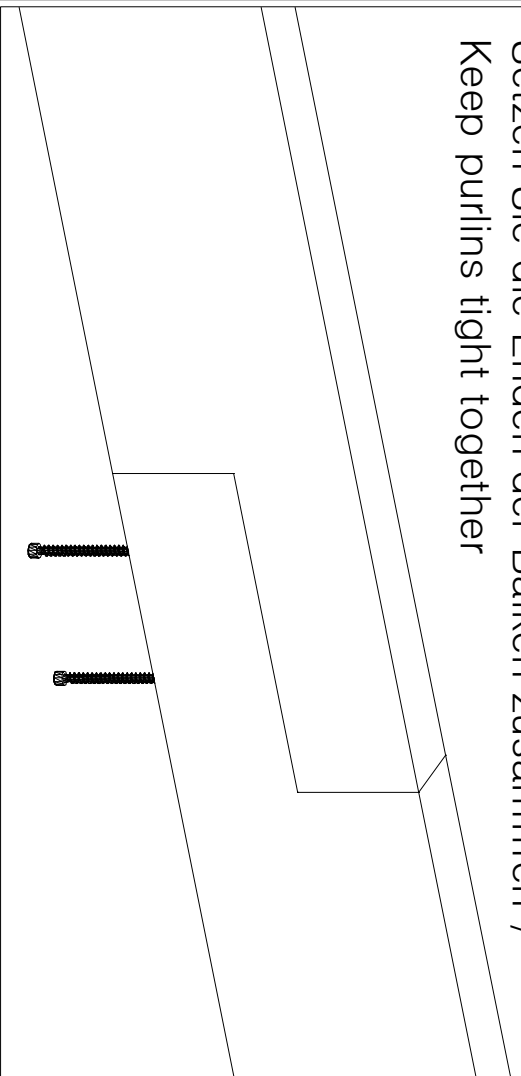

4

Keera kruvid lõpuni sisse /
Drehen Sie die Schrauben dann ganz ein /
Turn the screws up until the end

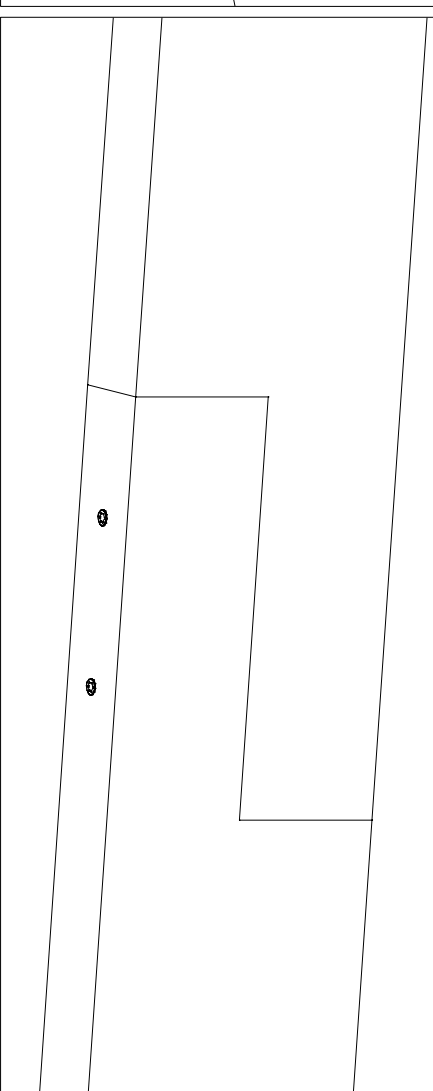

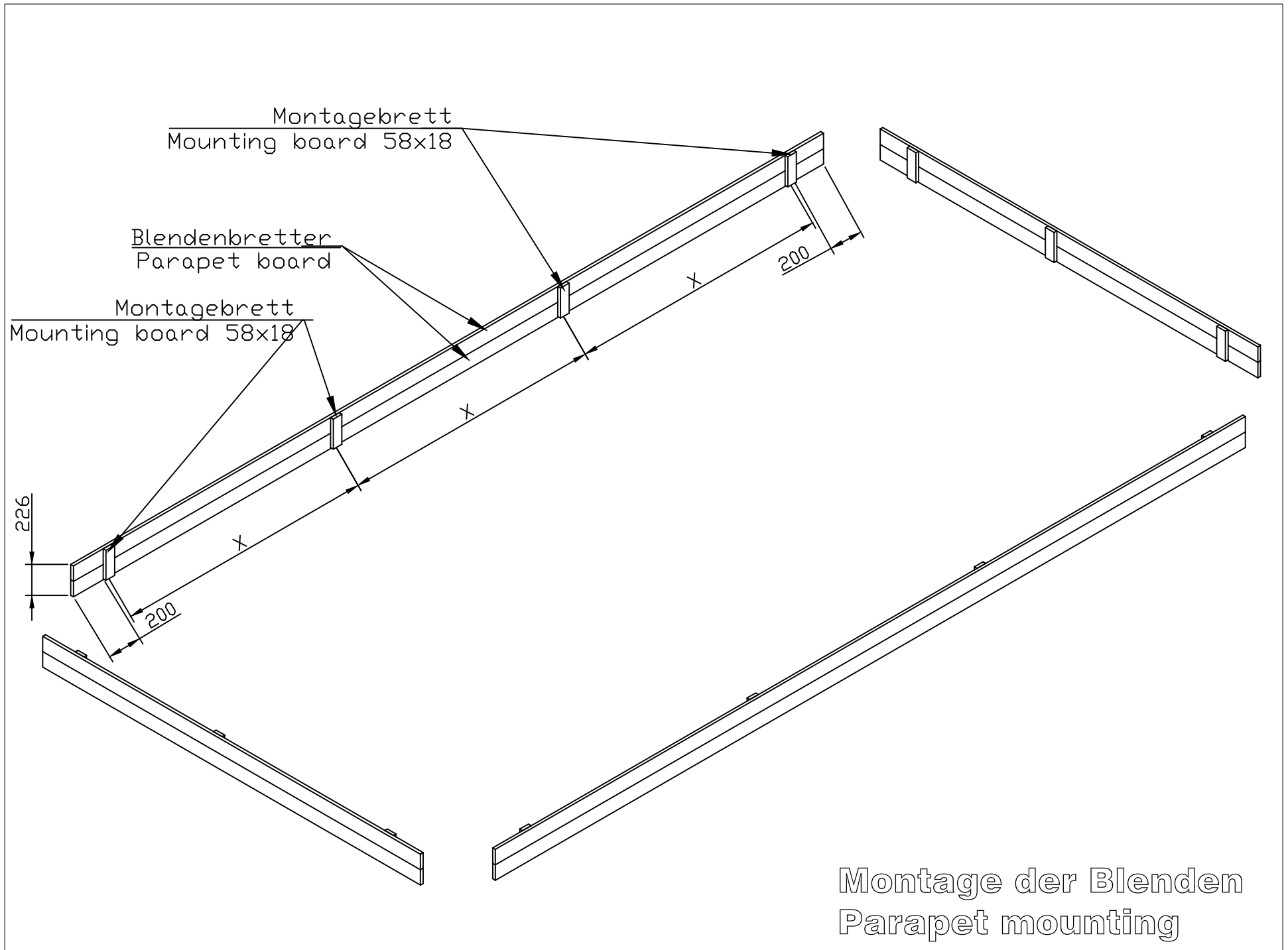

Montage der Blenden
Parapet mounting

Cutting support post / Schneiden der Stützpfosten



* Adjustment space for post support should be at least 50mm.

* Einstellraum für die Pfostenstütze muss mindestens 50mm sein.

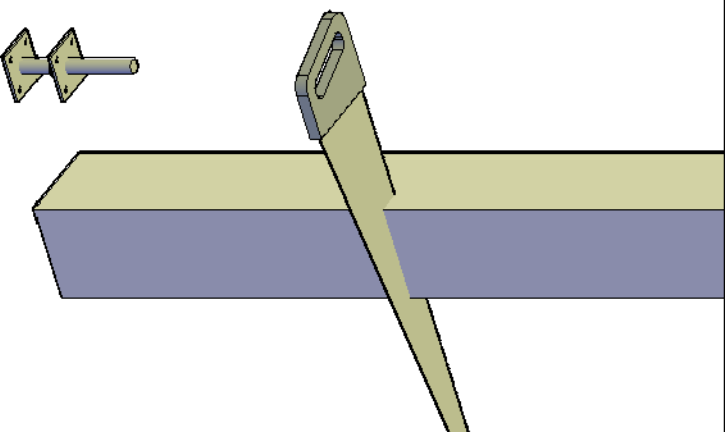

* Support post has extra length for various conditions. Must be sawn

to suitable length on spot considering local conditions.

* Stützpfosten hat extra Länge für verschiedene Bedingungen. Muss vor Ort unter Berücksichtigung der örtlichen Gegebenheiten zu einer geeigneten Länge gesägt werden.

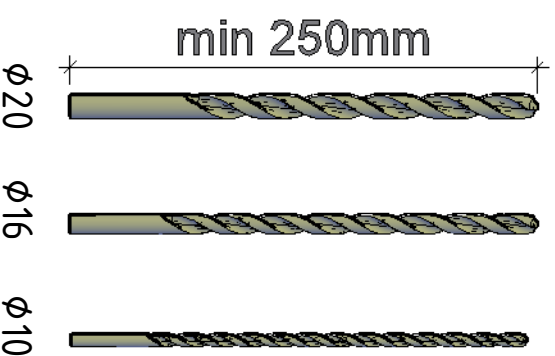
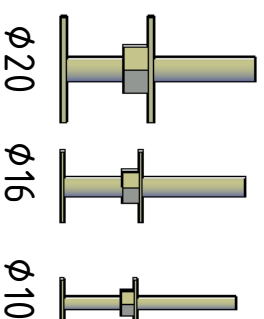

* In some cases you need to drill a new hole for a post support. Find a matching drill bit.

* In einigen Fällen müssen Sie ein neues Loch für die Pfostenstütze bohren. Finden Sie hier den passenden Bohrer.

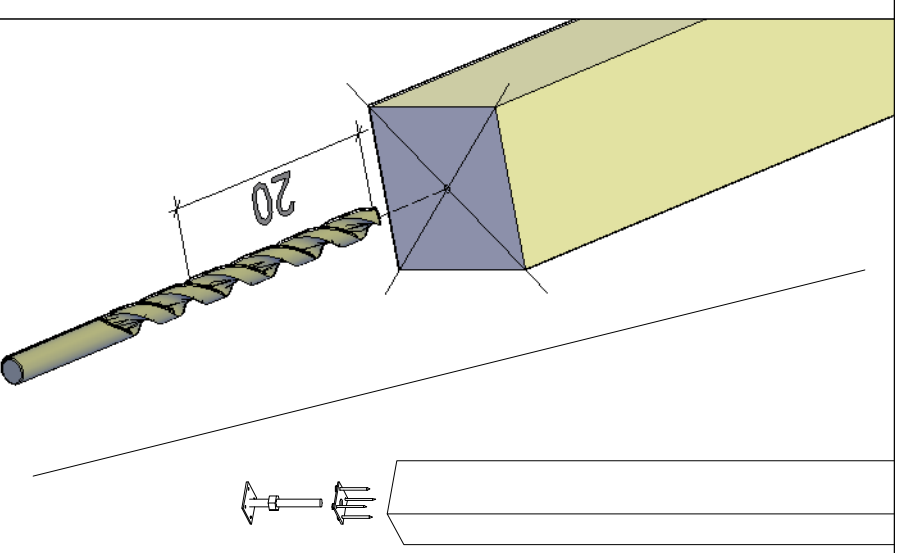

* Mark the center of the post and drill a new 20cm deep hole.

* Markieren Sie die Mitte des Pfostens und bohren Sie ein neues 20cm tiefes Loch. Danach mit Aufbau weiter machen.

Akna tüüp / Fenster typ / Window type - A68
(GH+ / SH)

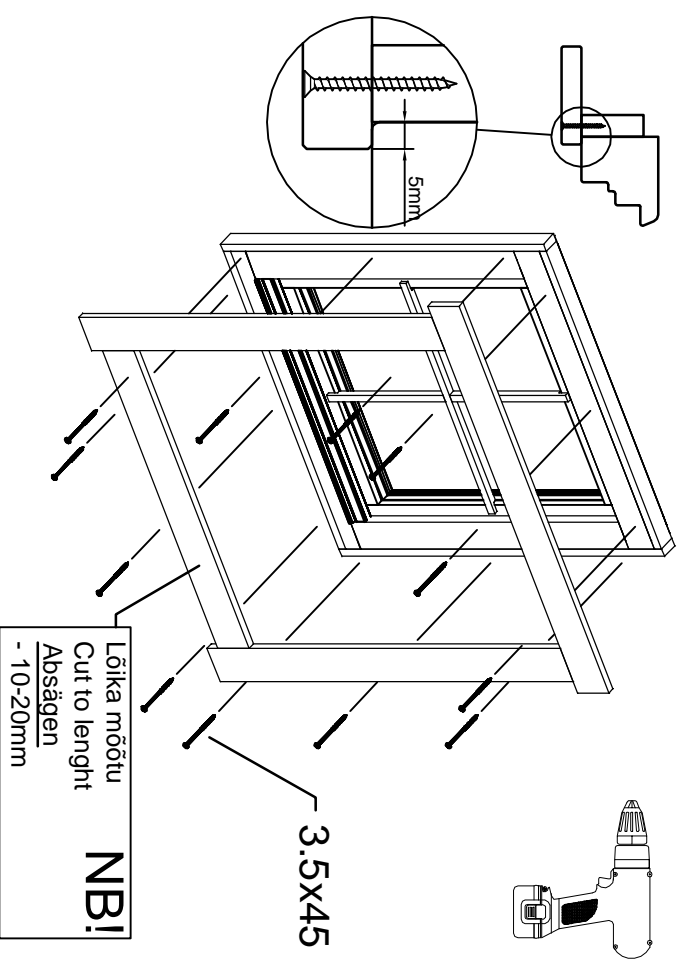
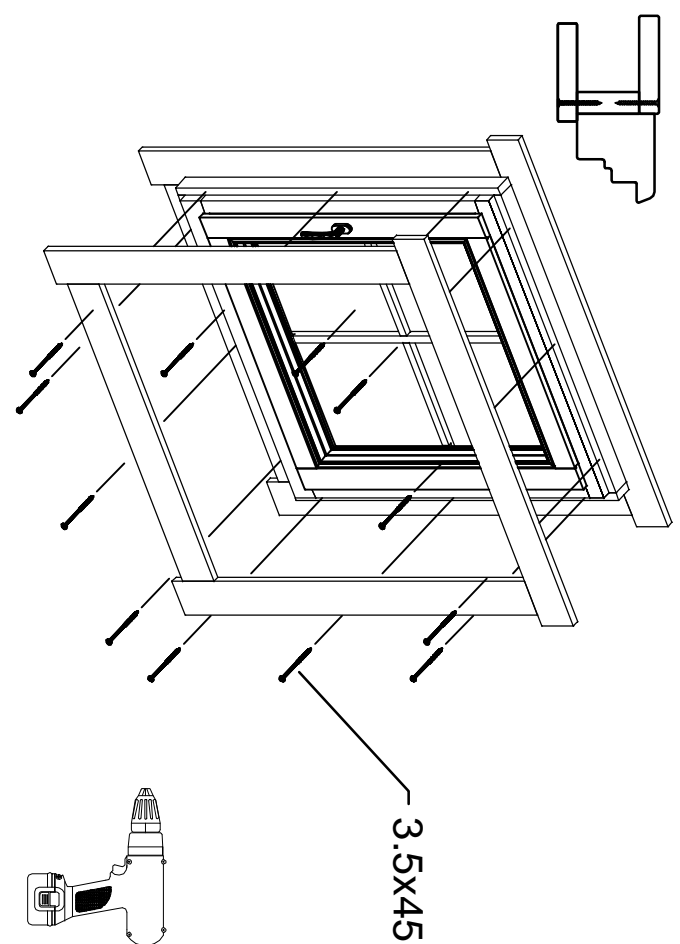
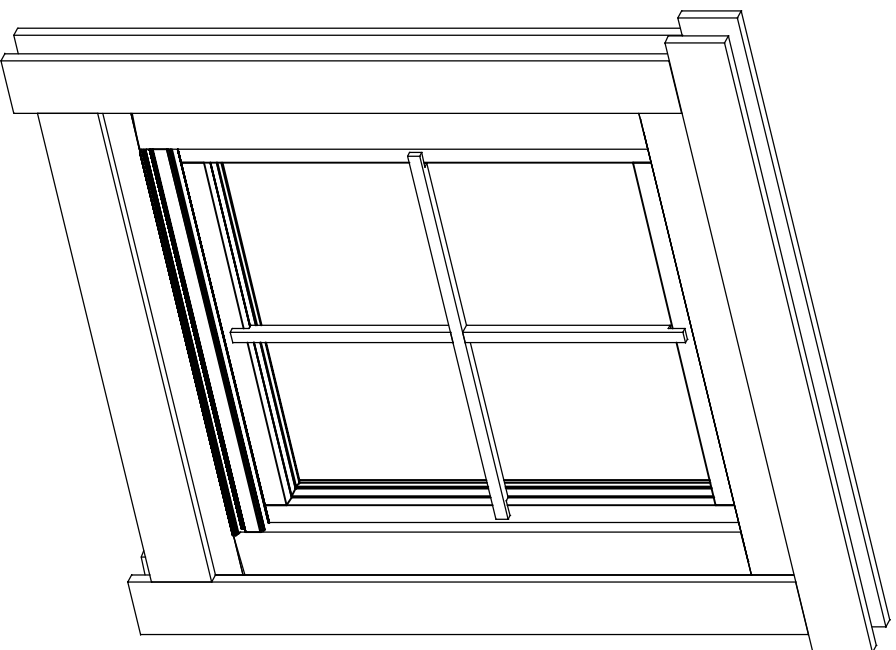

Ukse montaa 0 / Tür montage / Door assembly
(GH+ / SH)

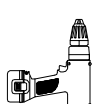
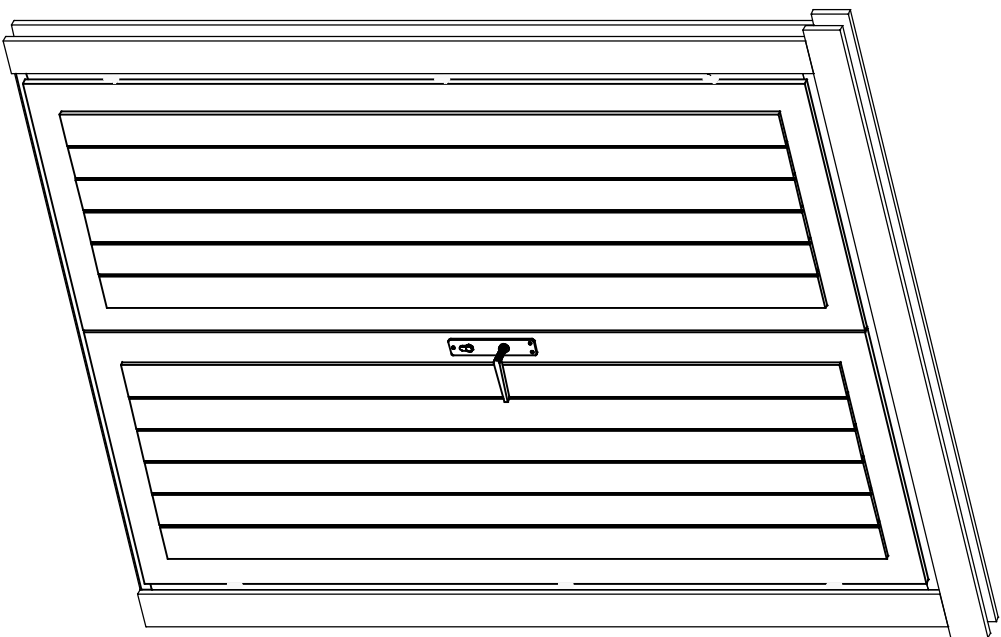

4.5x90

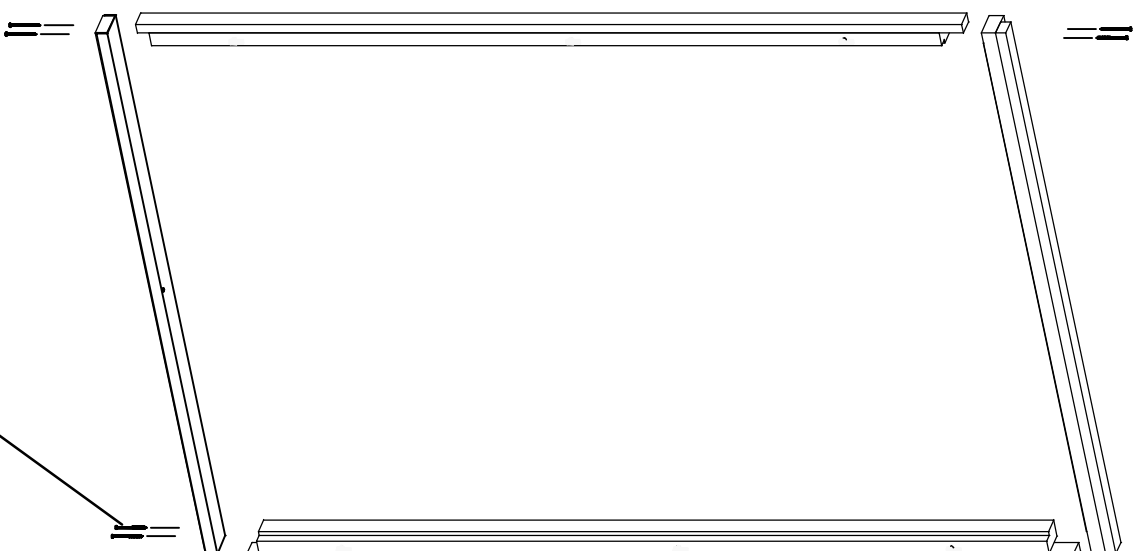

4.5x90

