

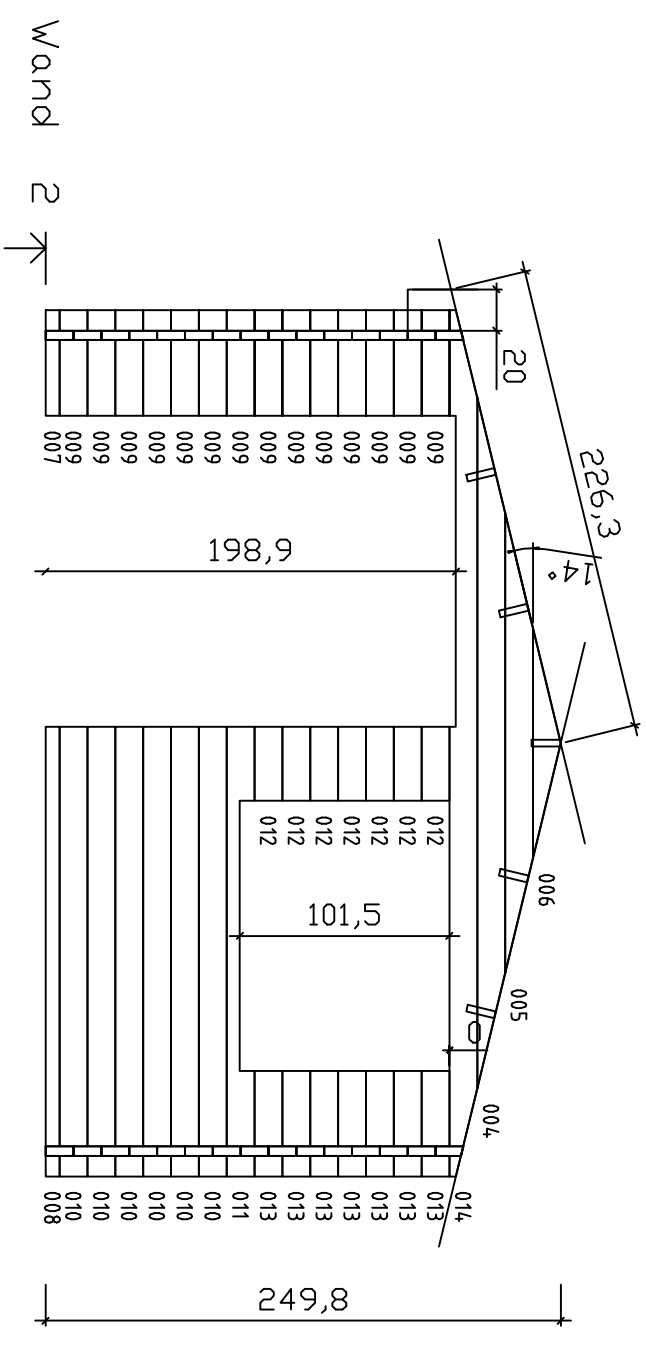

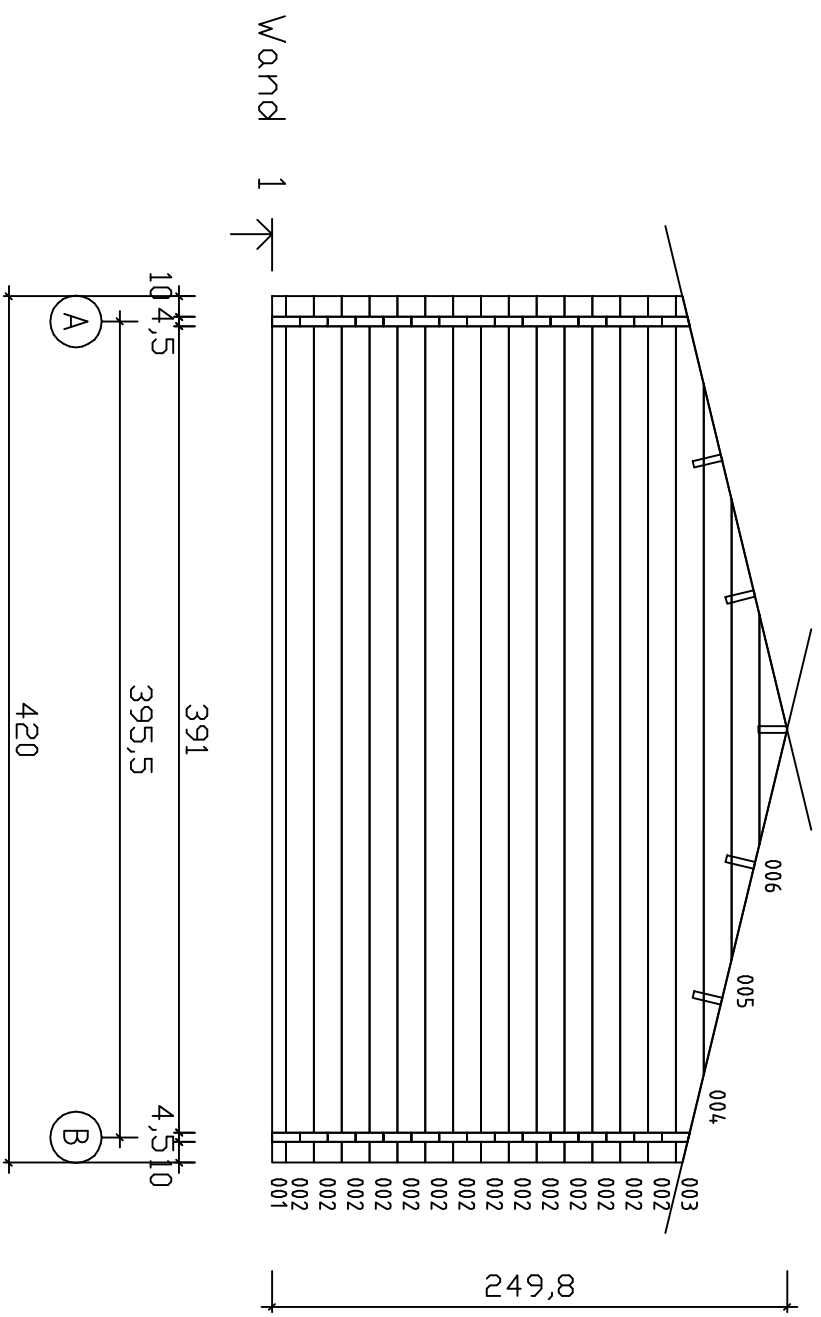

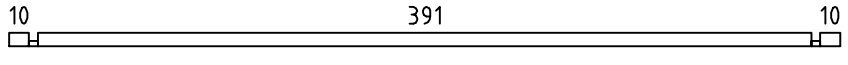

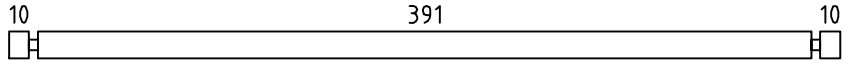
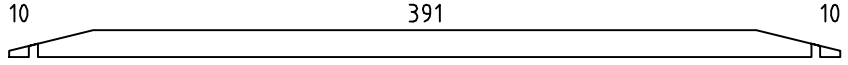
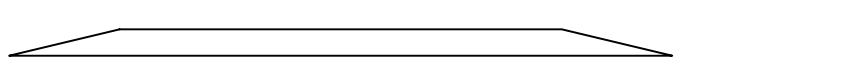
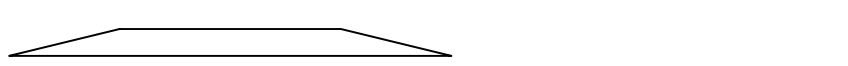

Kood	Inge 44	Leht	1
Joonis	Plaon	Mootkava	1:50
Materjal	4,5 x 13,5	Kuup.	28.11.2013
Joonestas	File	Haus	Inge 44 mm.

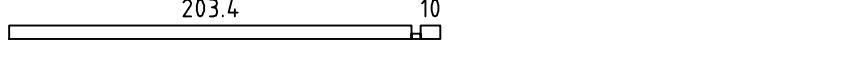

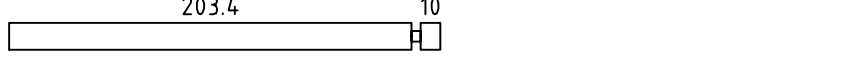
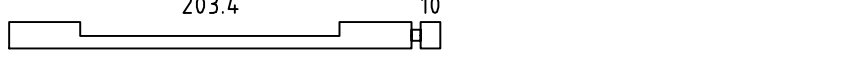
Kood	Inge 44	Leht	4
Joonis	Wand 1	Mootkava	1:50
Materjal	4,5X13,5	Kuup.	28.11.2013
Joonestass	File Haus Inge 44 mm.		

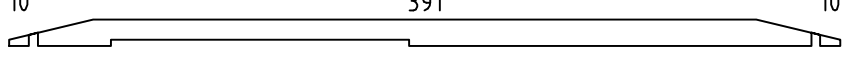
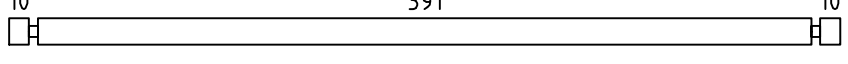
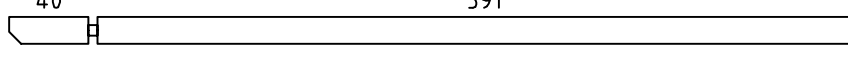
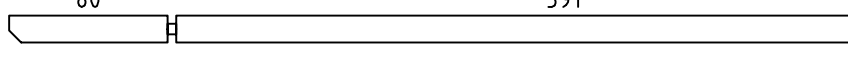
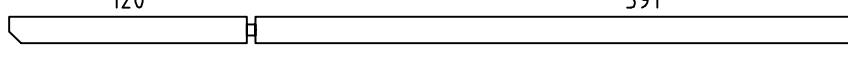
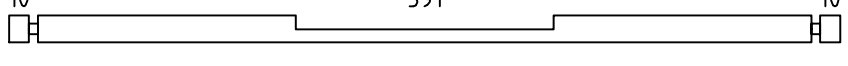
Pos	Drawing Inge 44	Pcs	Profile (cm)	Length (cm)
001		1	4.5x6.8	420
002		14	4.5x13.5	420
003		1	4.5x13.5	420
004		2	4.5x13.5	335.2
005		2	4.5x13.5	223.4
006		2	4.5x13.5	111.7
007		1	4.5x6.8	51.3
008		1	4.5x6.8	217.9
009		14	4.5x13.5	51.3
010		6	4.5x13.5	217.9
011		1	4.5x13.5	217.9
012		7	4.5x13.5	35.8
013		7	4.5x13.5	51
014		1	4.5x13.5	420
015		18	4.5x13.5	420
016		1	4.5x13.5	450
017		1	4.5x13.5	490
018		1	4.5x13.5	540
019		1	4.5x13.5	420
020		12	4.5x13.5	144.8
021		1	4.5x13.5	174.8
022		1	4.5x13.5	214.8
023		1	4.5x13.5	540
PR1		4	4.3x14.5	540
PR2		1	4.3x14.5	540
	WINDOW 129x99	2		
	DOOR 149.4x196.4	1		

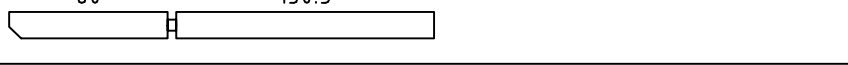
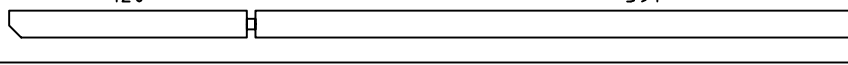
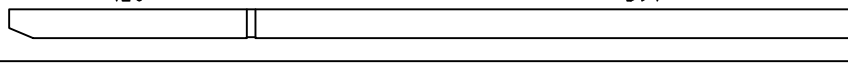
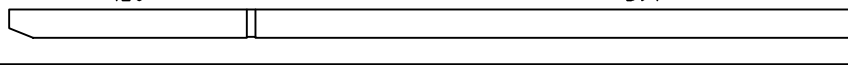
MATERIAL				
Inge 44				
DETAILS	B mm	H mm	L mm	ST.
WALLBEAMS	45	135		97
ROOF BOARDS	16	112	2260	98
ROOF PERIPHERY	18	60	5400	2
ROOF PERIPHERY	26	32	5400	2
ROOF PERIPHERY 14°	18	120	2310	4
	18	60	2310	4
ROOF BEAM	43	145	5400	5
DIAMOND				2
DOOR RIGHT	1494	1964	1/2.	1
WINDOW	1290	990		2