

BUILDING CODE

# INGRID

WALL LOG (mm): 28

SIZE (mm): 3000x3000

## COMPONENT SPECIFICATION

NUMBER	COMPONENT FUNCTION	COMPONENT CODE	VIEW	SIDE VIEW	DIMENSIONS (mm)			QUANTITY (psc.)
					LENGHT	WIDTH	THICKNESS	
1	Wall board	A2			1900	115	28	6
2	Wall board	A3			560	115	28	10
3	Wall board	A4			560	115	28	10
4	Wall board	A5			3000	115	28	1
5	Wall board	A6			3000	115	28	1
6	Wall board	B2, D1			3000	115	28	35
7	Wall board	B3			3000	115	28	1
8	Wall board	C1			1900	115	28	7
9	Wall board	C2			560	115	28	10
10	Wall board	C3			560	115	28	10
11	Wall board	C4			3000	115	28	1
12	Wall board	C5			3000	115	28	1
13	Wall board	D2			3000	115	28	1
14	Wall board	F1			1755	115	28	1
15	Wall board	F2			275	115	28	16
16	Wall board	F3			275	115	28	15
17	Wall board	F4			275	115	28	1
18	Wall board	F5			1755	115	28	1
19	Wall board							
20	Wall board	A1			1900	60	28	1
21	Wall board	B1			3000	60	28	1
22	Roof board						19	8
23	Window				770	1120		2
24	Door				1200	1880		1
25	Roof cover fixture				3300/1650	100/120	16	4/8
26	Beam				2330	60	40	4
27	Beam				1785	60	40	4
28	Beam				1010	60	40	8
29	Octagon							1
30								
31								
32								
33								
34								
35								
36								
37								
38								
39								
40								

PACKAGE NR.:

MNFCT. ORDER NR.:

CONTROL 1

CONTROL 2

PAGE/PAGES:

**1/6**

SIGNATURE

SIGNATURE

BUILDING CODE

# INGRID

WALL LOG (mm): 28

SIZE (mm): 3000x3000

## ISOMETRIC VIEW



## TOP VIEW

A-FRONT  
B-BACK  
C-LEFT  
D-RIGHT  
F-CORNER

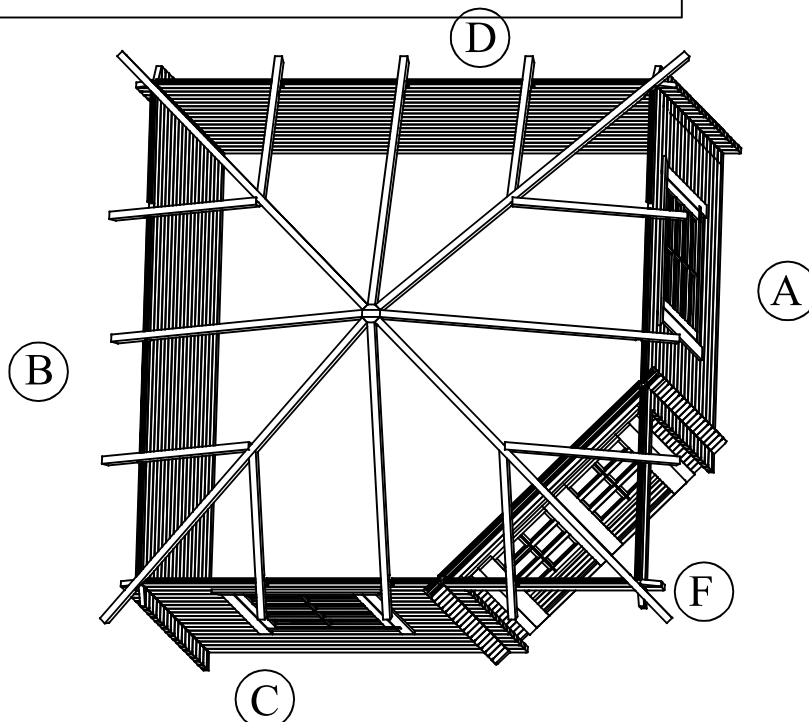

PACKAGE NR.:

MNFCT. ORDER NR.:

**CONTROL 1**  
SIGNATURE

**CONTROL 2**  
SIGNATURE

PAGE/PAGES: **2/6**

BUILDING CODE

# INGRID

WALL LOG (mm): 28

SIZE (mm): 3000x3000

## FRONT VIEW

(A)

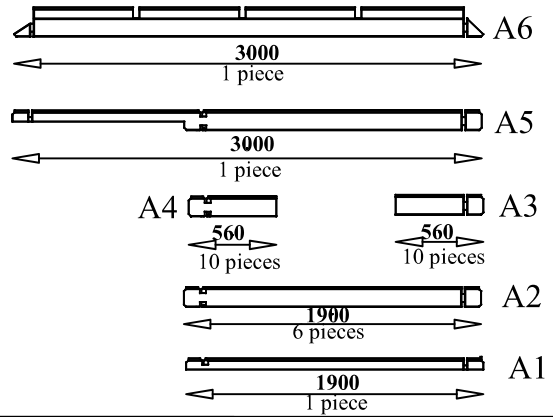
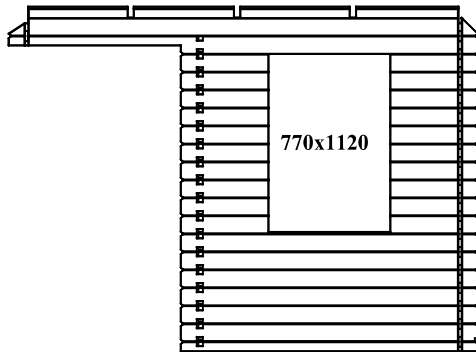

## CORNER VIEW

(F)

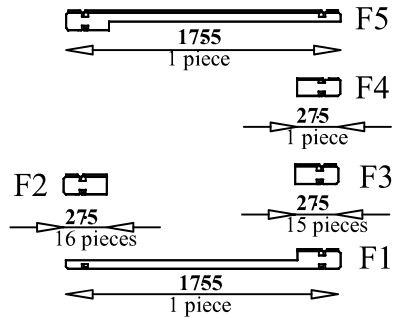
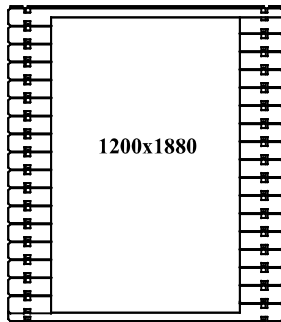

## BACK VIEW

(B)

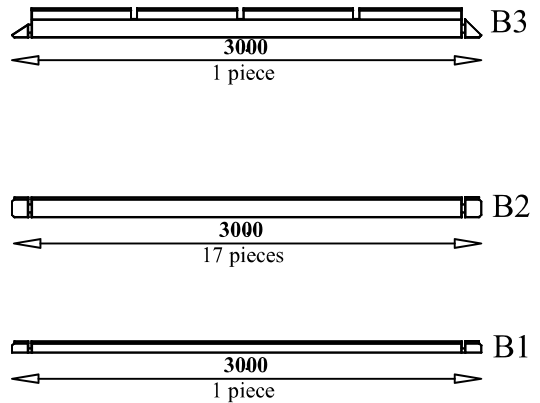
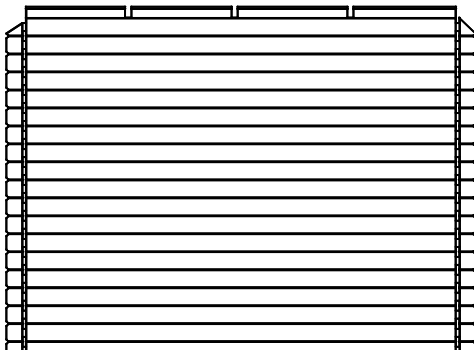

PACKAGE NR.:

MNFCT. ORDER NR.:

CONTROL 1

CONTROL 2

SIGNATURE

SIGNATURE

PAGE/PAGES: **3/6**

BUILDING CODE

# INGRID

WALL LOG (mm): 28

SIZE (mm): 3000x3000

## LEFT VIEW

(C)

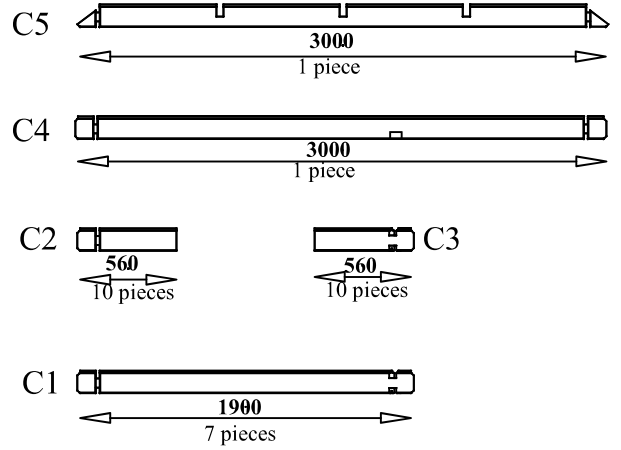
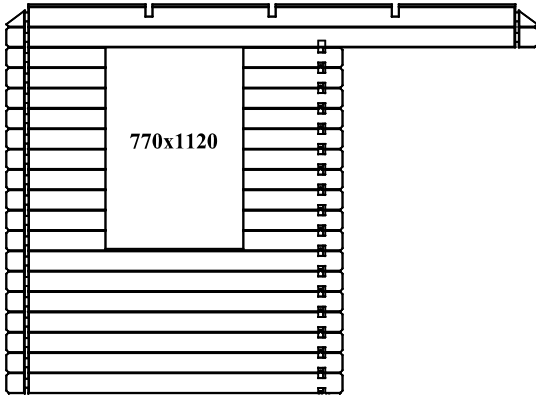

## RIGHT VIEW

(D)

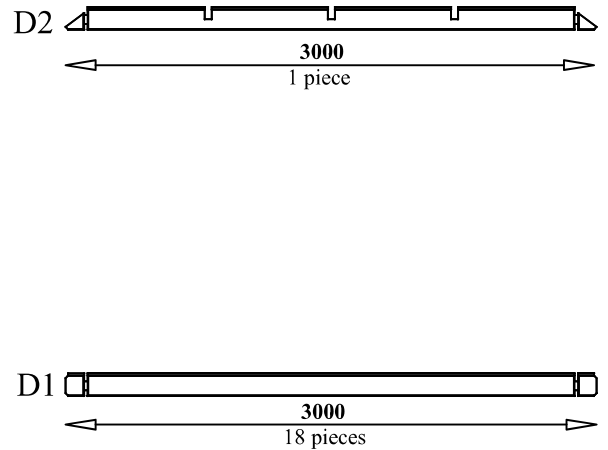
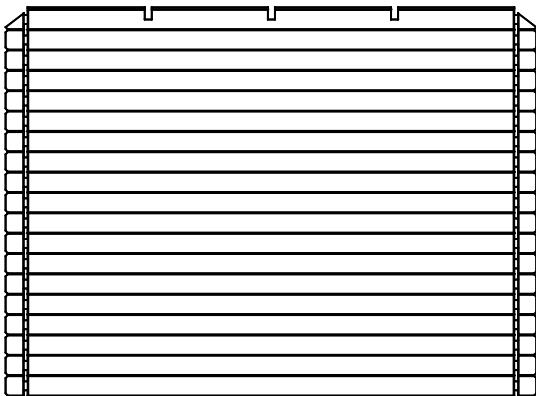

PACKAGE NR.:

MNFCT. ORDER NR.:

**CONTROL 1**  
SIGNATURE

**CONTROL 2**  
SIGNATURE

PAGE/PAGES: **4/6**

BUILDING CODE

# INGRID

WALL LOG (mm): 28

SIZE (mm): 3000x3000

## CONSTRUCCION 1

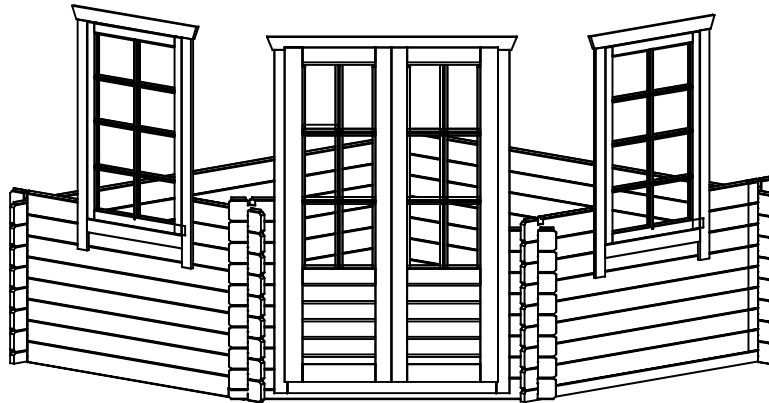

## CONSTRUCCION 2

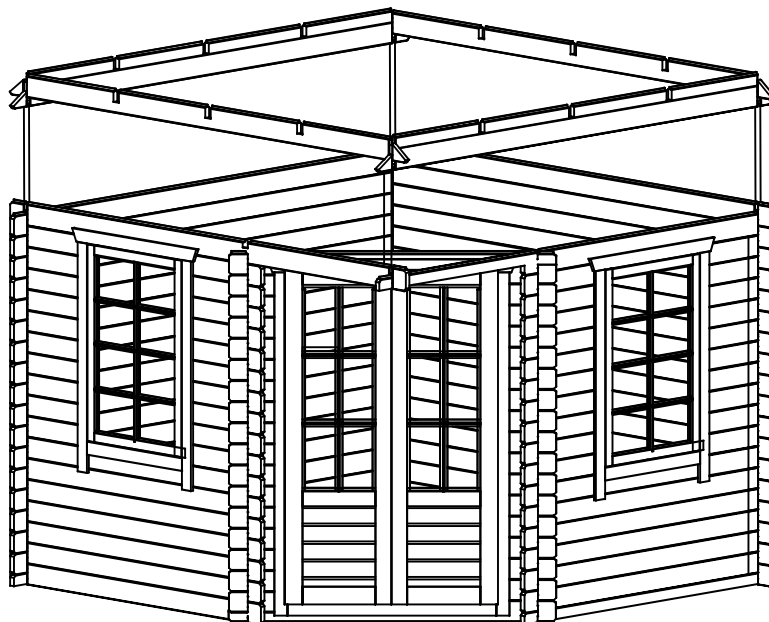

PACKAGE NR.:

MNFCT. ORDER NR.:

**CONTROL 1**  
SIGNATURE

**CONTROL 2**  
SIGNATURE

PAGE/PAGES: **5/6**

BUILDING CODE

# INGRID

WALL LOG (mm): 28

SIZE (mm): 3000x3000

## CONSTRUCCION 3

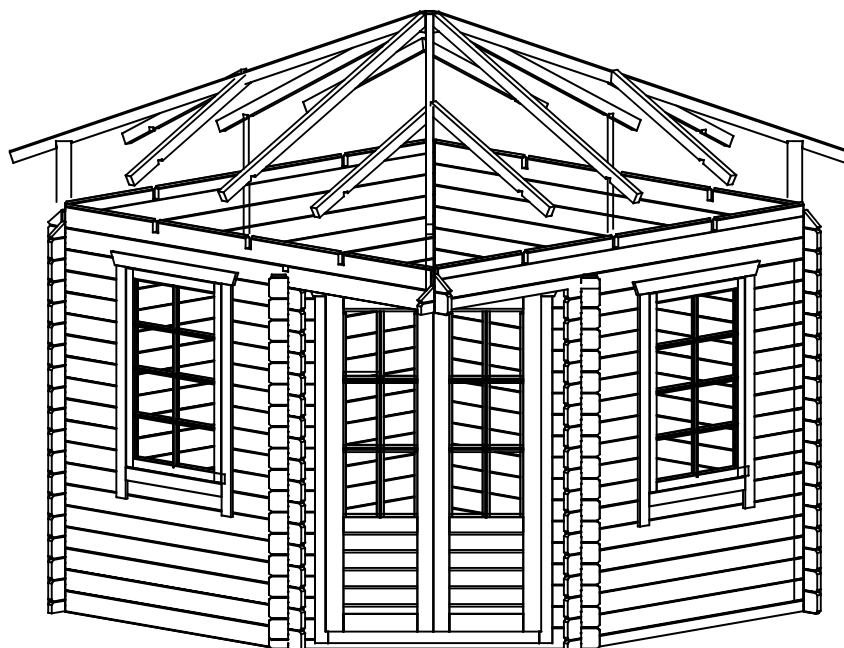

## CONSTRUCCION 4

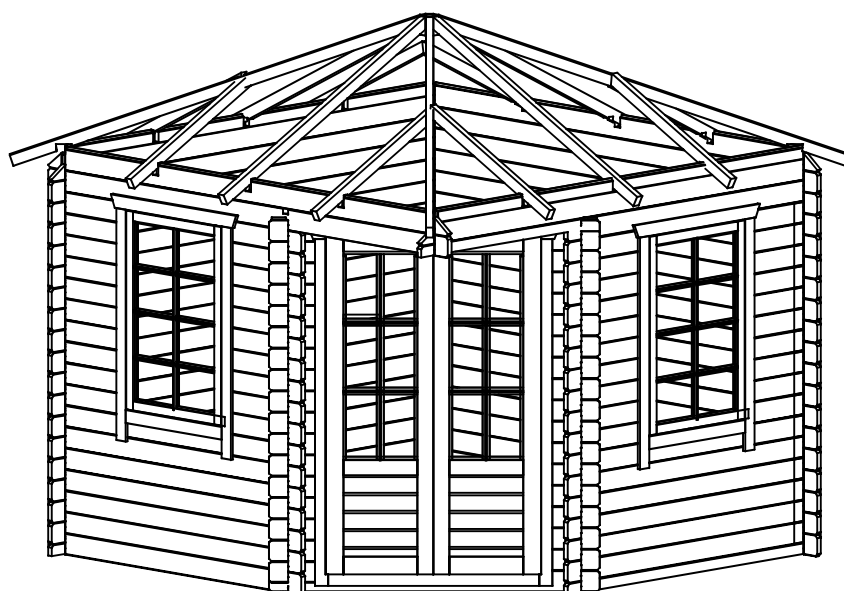

PACKAGE NR.:

MNFCT. ORDER NR.:

**CONTROL 1**

**CONTROL 2**

SIGNATURE

SIGNATURE

PAGE/PAGES: **6/6**