











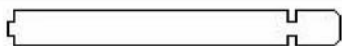

Pos	LEEDS 4,4 x 4,4 + 3,0 58x135	Profile	Length	St.	
D5 C7		58x135	4391	2	
D6 C8			3149	2	
D3 C3 E6 B2		58x135	4400	30	
C4			4400	1	
A3			4400	1	
D1 C1			4271	8	
D2 C2			3029	8	
C6			1137	14	
E2			1050	4	
E5			1050	2	
A2			560	28	
C9 D7 E4			400	8	
C5 D4 E3			258	44	
B1 A1			58 x 67	4400	2
E1				1050	2
A4 B4 E7	APEX 4 доски		58x135	4400	3
25	ROOFING BOARDS 	19 x 85	2380	178	
26	WINDOW	2126 x 966		1	
27	Block of doors	3280 x 1938		1	
28	Roof of cover fixture 	20x120 or 20x145	2430	4	
30	Roof of cover fixture 	20x95	2450	4	
37	Beam	40x40	3770	4	
38	ROOF JOIST	58x145	4520	4	
39			3278	4	
38\1	RIDGE BEAM		4391	1	
39\1			3149	1	
52	Amrest 	20x95	2972	2	
			822	2	
			675	2	
53	Diamond 			2	
E8	Beam	40x40	2052	2	

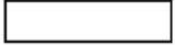
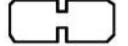

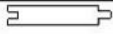
LEEDS

4,4 x 4,4 + 3,0 58 mm

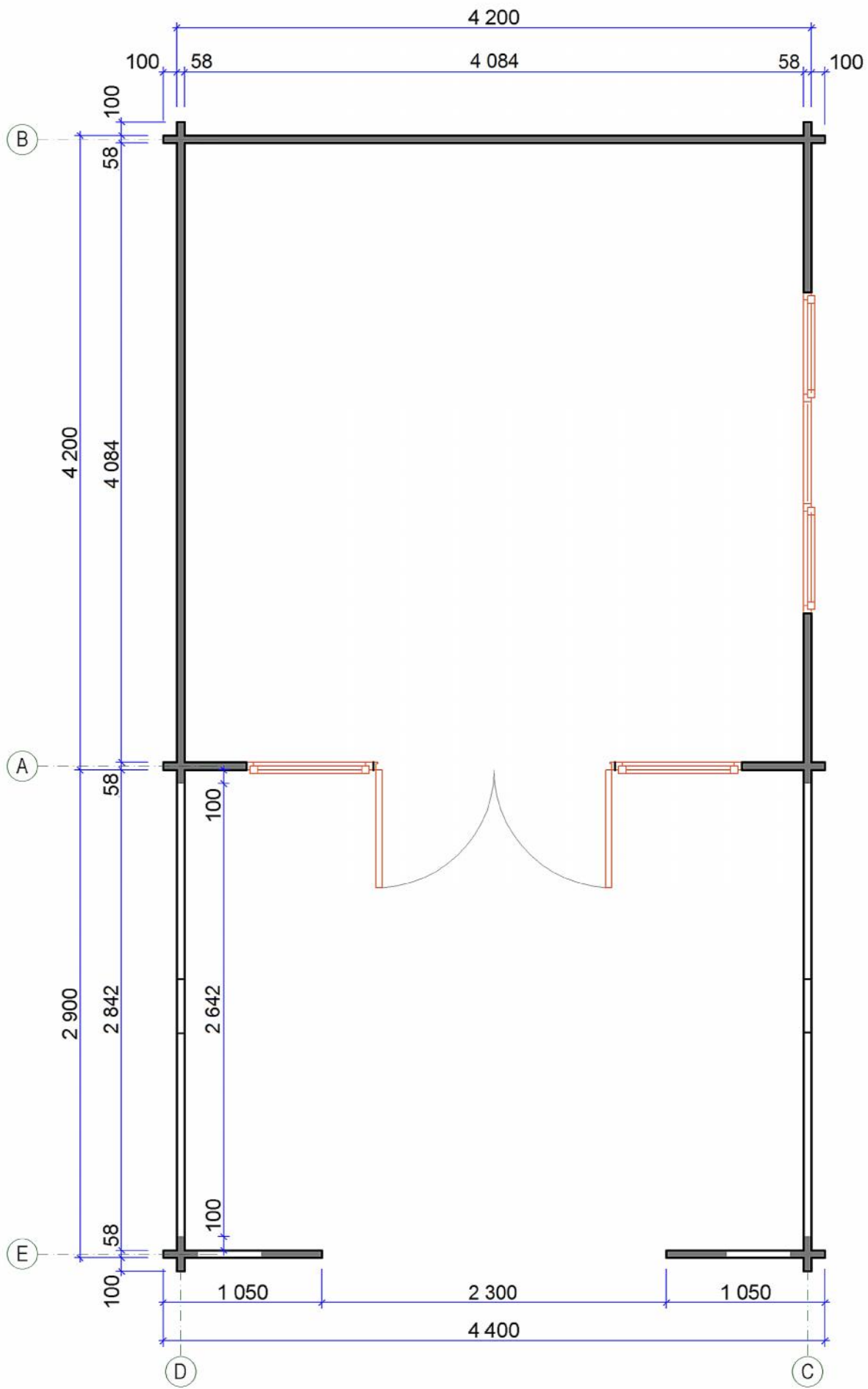
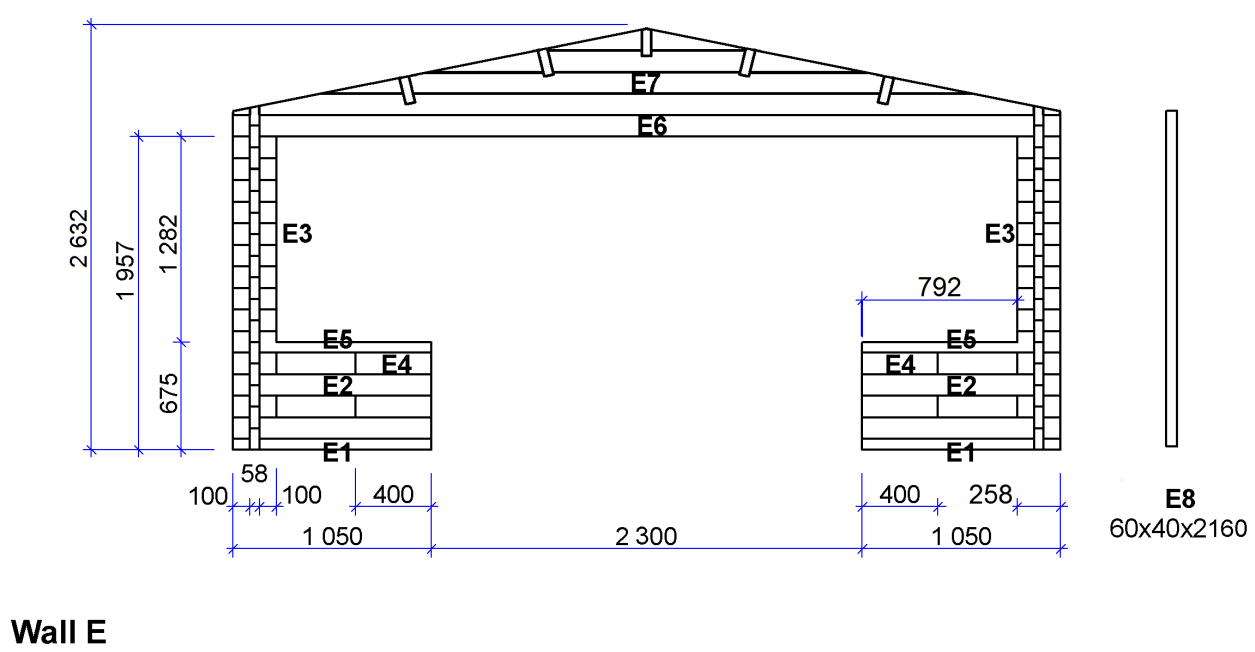
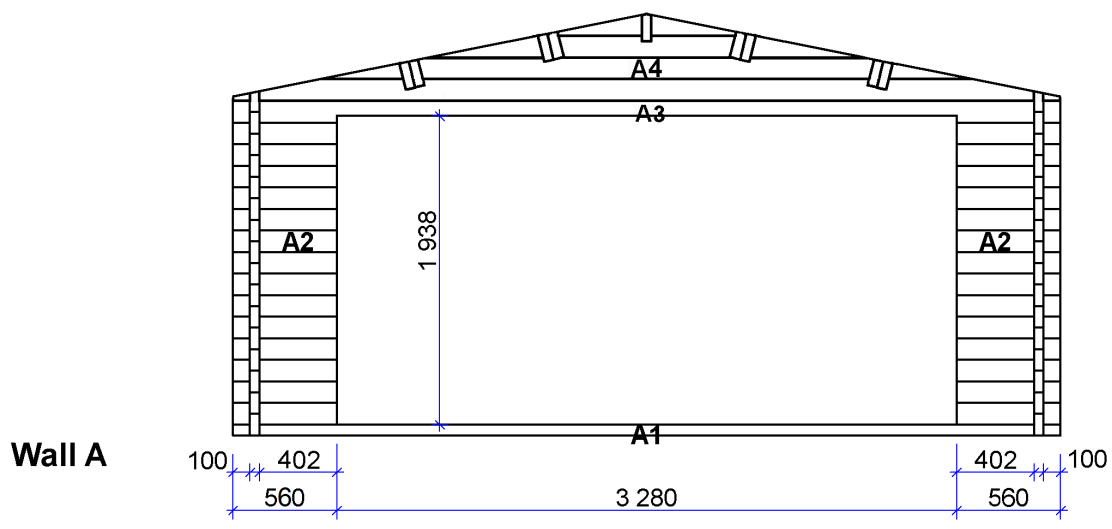
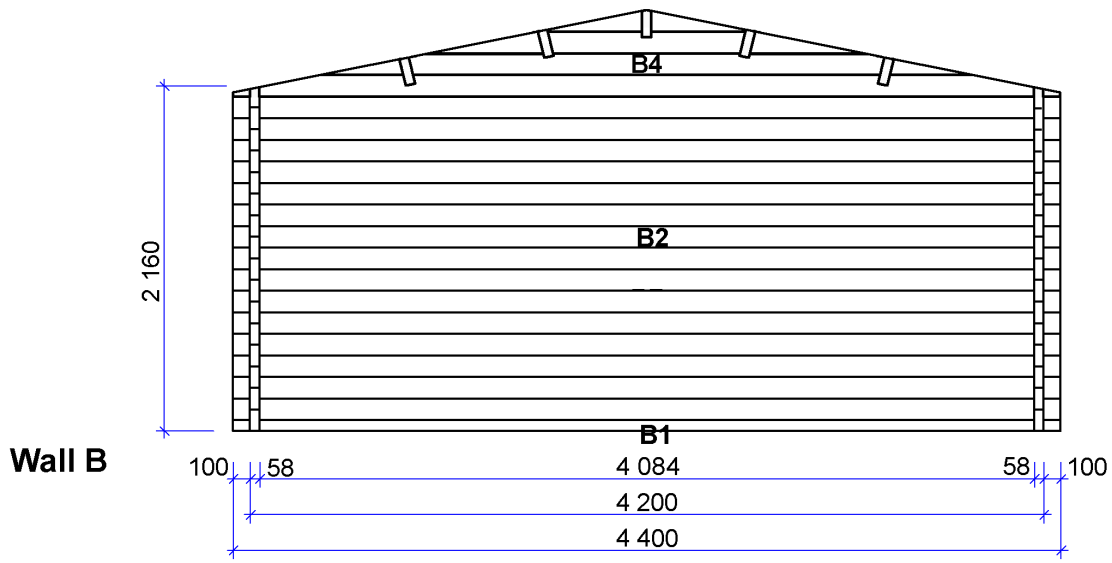

LEEDS **4,4 x 4,4 + 3,0** **58\135 mm**

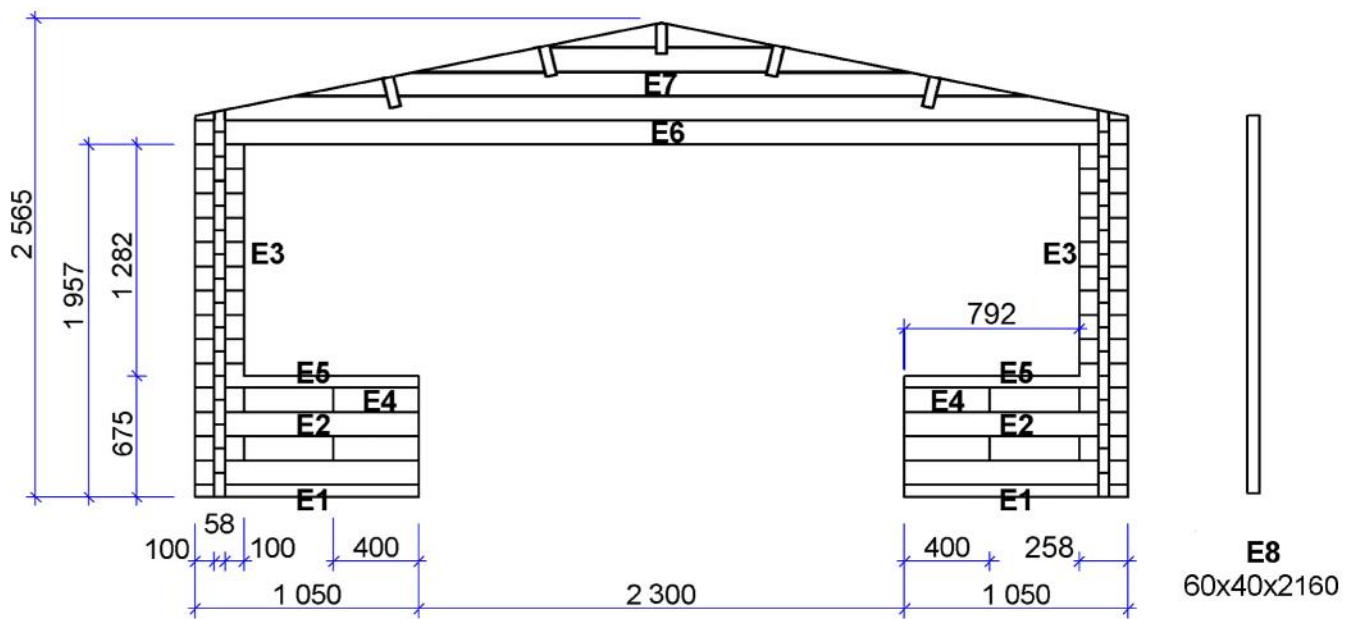
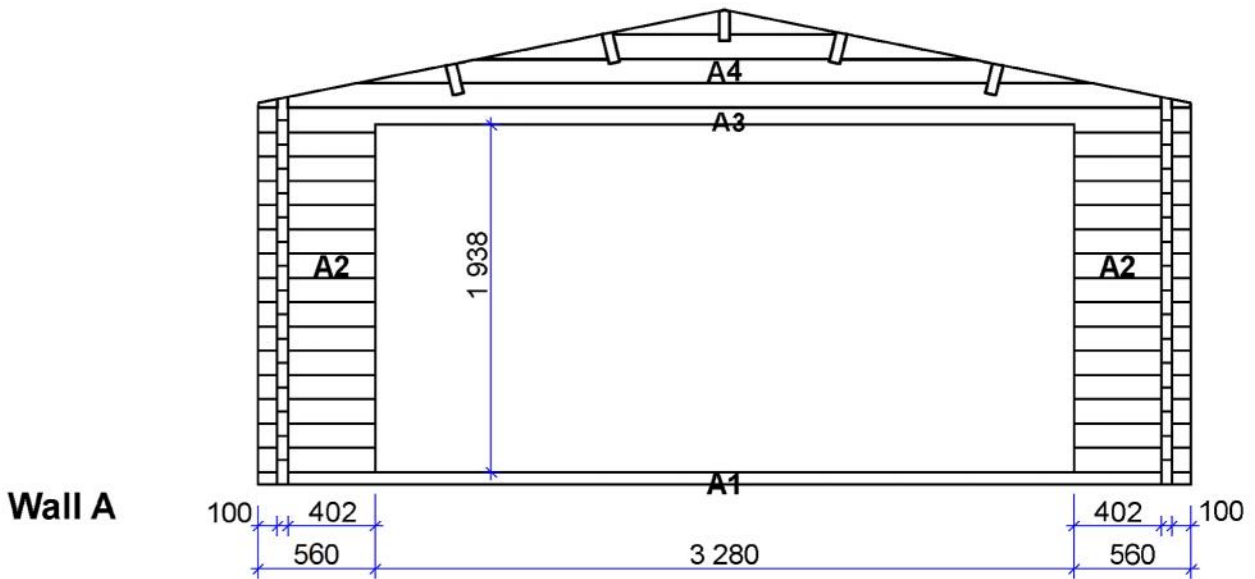
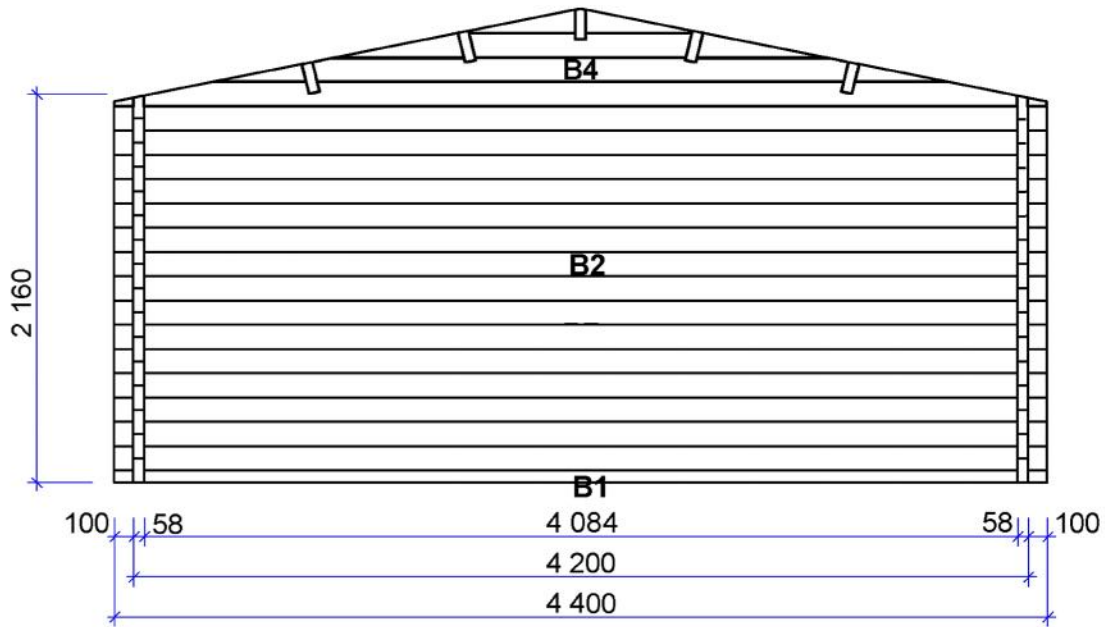

Wall E

LEEDS

4,4 x 4,4 + 3,0

58\135 mm