

Always keep the package number saved! Without package number their is no guarantee.:

Package number:

WALL LOG (mm): 28

BUILDING CODE **MARKKU**

SIZE (mm): 5760x3000

COMPONENT SPECIFICATION

| NUMBER | COMPONENT FUNCTION | COMPONENT CODE | VIEW | SIDE VIEW | DIMENSIONS (mm) | | | QUANTITY (psc.) |
|--------|--------------------|----------------|------|-----------|-----------------------------|-------|-----------|-----------------|
| | | | | | LENGHT | WIDTH | THICKNESS | |
| 1 | Wall board | A1 | | | 2028 | 115 | 28 | 6 |
| 2 | Wall board | A2 | | | 624 | 115 | 28 | 10 |
| 3 | Wall board | A3 | | | 624 | 115 | 28 | 10 |
| 4 | Wall board | A4 | | | 5760 | 115 | 28 | 1 |
| 5 | Wall board | A5, B2 | | | 5760 | 115 | 28 | 2 |
| 6 | Wall board | B1 | | | 5760 | 115 | 28 | 17 |
| 7 | Wall board | C2 | | | 320 | 115 | 28 | 16 |
| 8 | Wall board | C3,D5,E2 | | | 3000 | 115 | 28 | 19 |
| 9 | Wall board | C4, E3 | | | 3000 | 115 | 28 | 2 |
| 10 | Wall board | D2 | | | 2034 | 115 | 28 | 6 |
| 11 | Wall board | D3 | | | 627 | 115 | 28 | 10 |
| 12 | Wall board | D4 | | | 627 | 115 | 28 | 10 |
| 13 | Wall board | | | | | | | |
| 14 | Wall board | | | | | | | |
| 15 | Wall board | | | | | | | |
| 16 | Wall board | | | | | | | |
| 17 | Wall board | | | | | | | |
| 18 | Wall board | E1 | | | 3000 | 60 | 28 | 1 |
| 19 | Wall board | D1 | | | 2034 | 60 | 28 | 1 |
| 20 | Wall board | C1 | | | 320 | 60 | 28 | 1 |
| 21 | Apex | D6 | | | 3000 | | 28 | 1 |
| 22 | Bracer | C5 | | | 1880 | 40 | 28 | 1 |
| 23 | Door | D-4 | | | 1200 | 1880 | 28 | 1 |
| 24 | Window | W-1 | | | 770 | 1120 | 28 | 2 |
| 25 | Column | A6 | | | 1890 | 100 | 60 | 1 |
| 26 | Roof cover fixture | | | | 3300/3100 | 100 | 16 | 2/4 |
| 27 | Roof board | | | | | | | |
| 28 | Beam | | | | 2303/1752/ 1715/1700/990 | 60 | 40 | 4/4/2/2/8 |
| 29 | Beam with octagon | | | | | 120 | 40 | 1 |
| 30 | | | | | | | | |

PACKAGE NR.:

MNFCT. ORDER NR.:

CONTROL 1

CONTROL 2

PAGE/PAGES:

1/7

SIGNATURE

SIGNATURE

BUILDING CODE **MARKKU**

WALL LOG (mm): 28

SIZE (mm): 5760x3000

ISOMETRIC VIEW

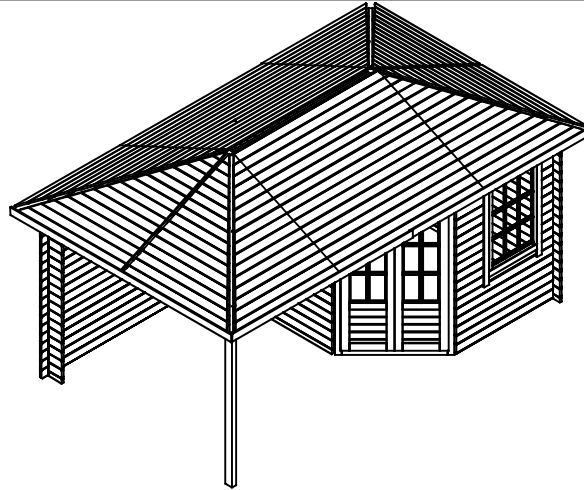
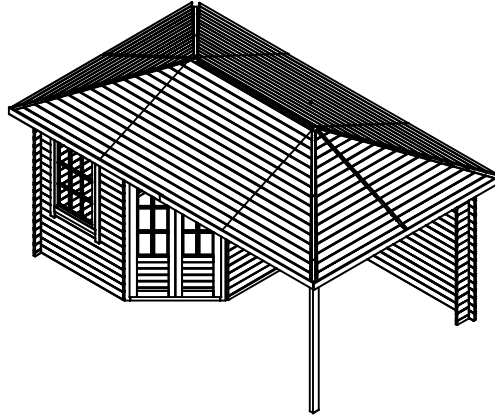

TOP VIEW

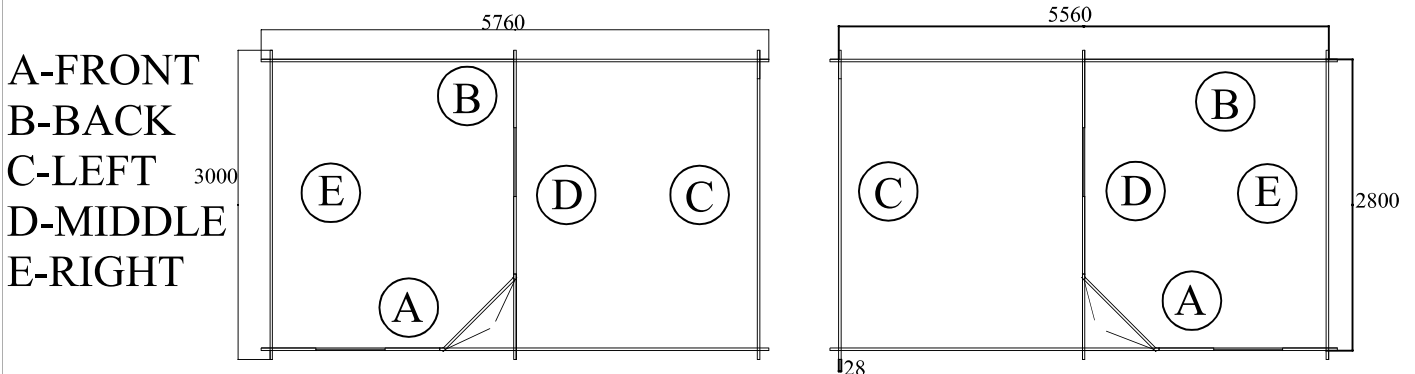

PACKAGE NR.:

MNFCT. ORDER NR.:

CONTROL 1

CONTROL 2

SIGNATURE

SIGNATURE

PAGE/PAGES: **2/7**

BUILDING CODE **MARKKU**

WALL LOG (mm): 28

SIZE (mm): 5760x3000

FRONT VIEW

(A)

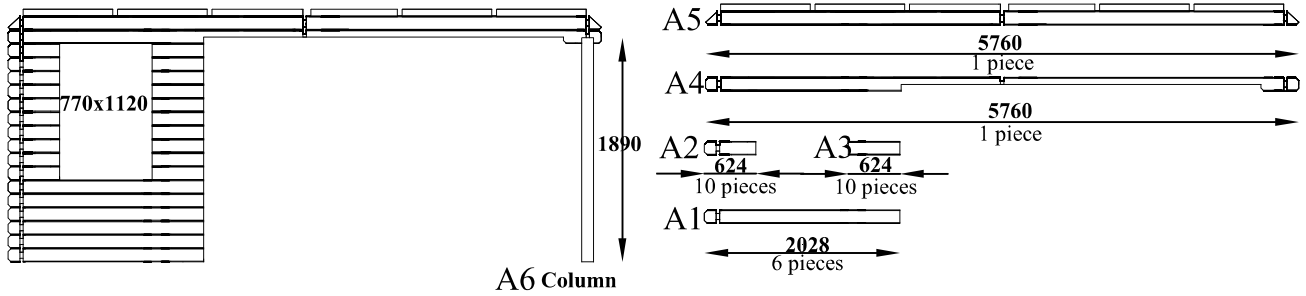

BACK VIEW

(B)

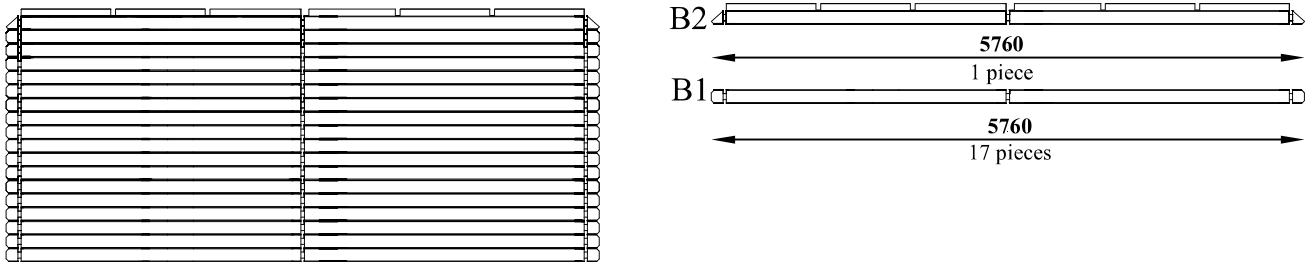

PACKAGE NR.:

MNFCT. ORDER NR.:

CONTROL 1

CONTROL 2

SIGNATURE

SIGNATURE

PAGE/PAGES:

3/7

BUILDING CODE

MARKKU

WALL LOG (mm): 28

SIZE (mm): 5760x3000

LEFT VIEW

Ⓒ

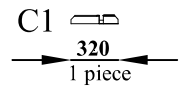
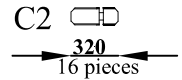
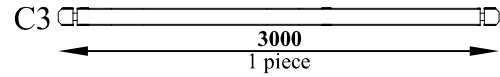
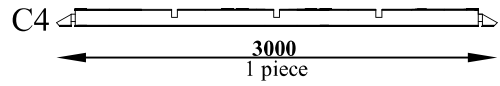
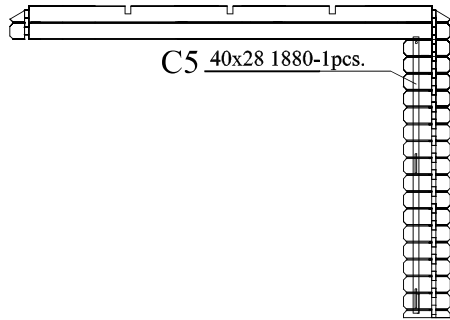

MIDDLE VIEW

Ⓓ

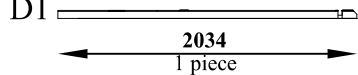
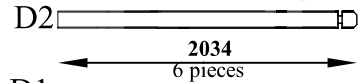
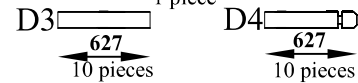
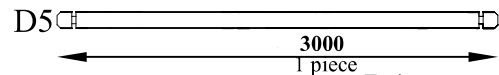
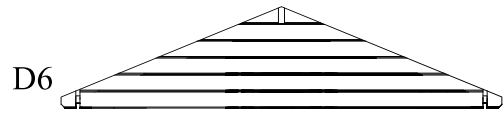
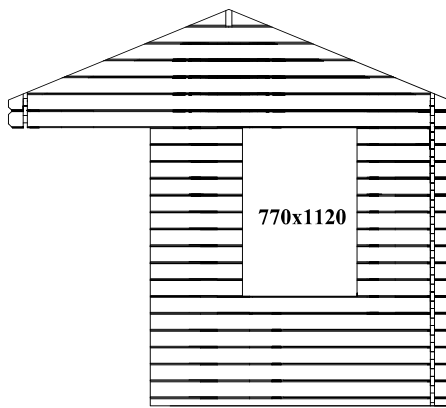

1900
7 pieces

RIGHT VIEW

Ⓔ

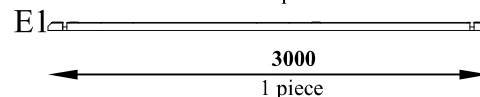
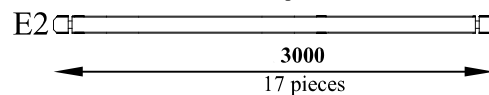
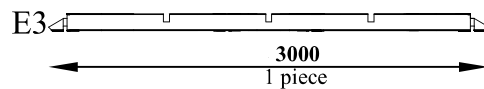
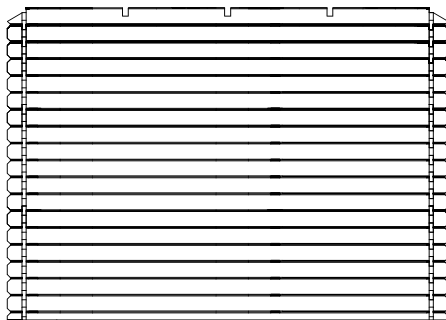

PACKAGE NR.:

MNFCT. ORDER NR.:

CONTROL 1

CONTROL 2

SIGNATURE

SIGNATURE

PAGE/PAGES:

4/7

BUILDING CODE **MARKKU**

WALL LOG (mm): 28

SIZE (mm): 5760x3000

CONSTRUCCION 1

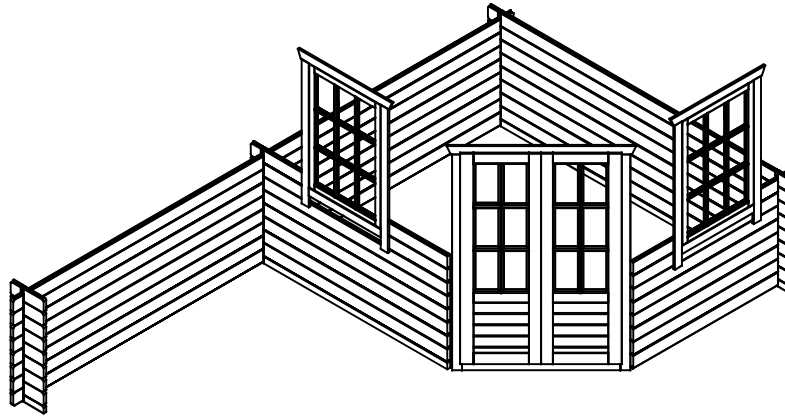

CONSTRUCCION 2

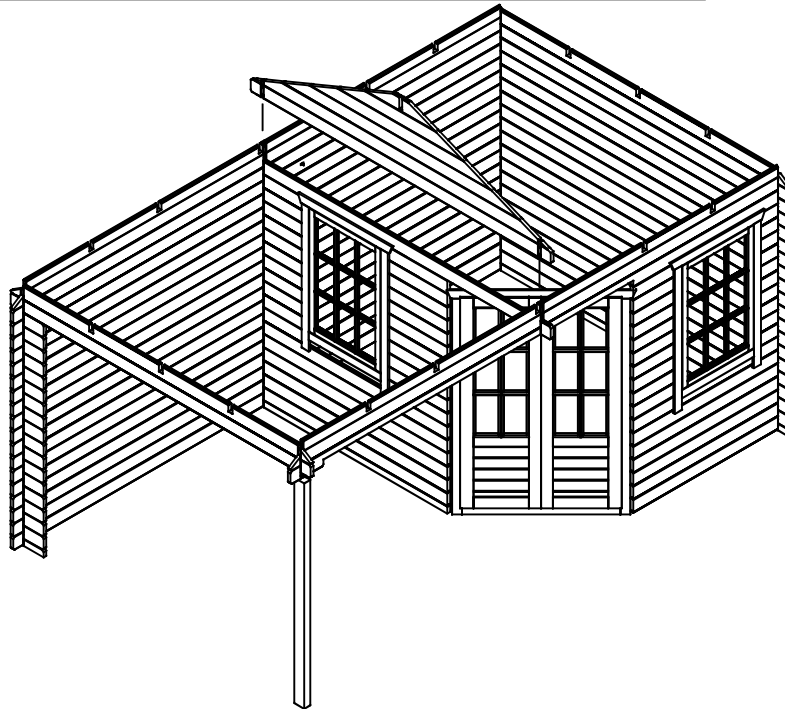

PACKAGE NR.:

MNFCT. ORDER NR.:

CONTROL 1

CONTROL 2

SIGNATURE

SIGNATURE

PAGE/PAGES: **5/7**

BUILDING CODE **MARKKU**

WALL LOG (mm): 28

SIZE (mm): 5760x3000

CONSTRUCCION 3

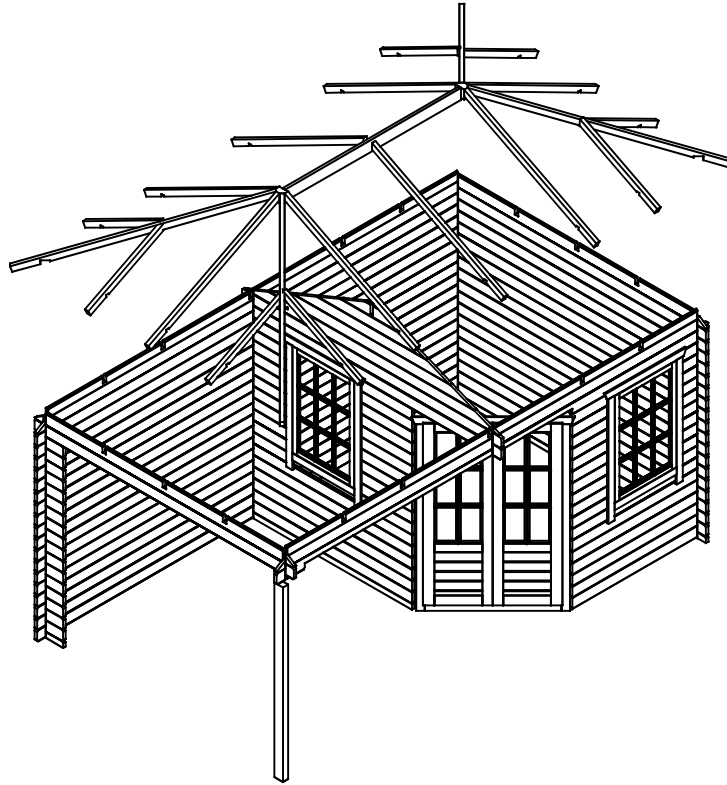

CONSTRUCCION 4

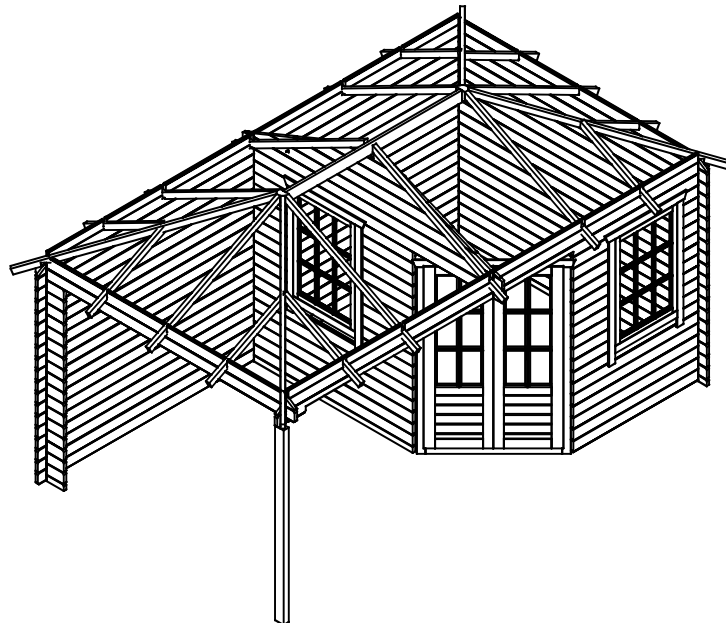

PACKAGE NR.:

MNFCT. ORDER NR.:

CONTROL 1

CONTROL 2

SIGNATURE

SIGNATURE

PAGE/PAGES: **6/7**

BUILDING CODE **MARKKU**

WALL LOG (mm): 28

SIZE (mm): 5760x3000

ISOMETRIC ROOF'S CONSTRUCTION

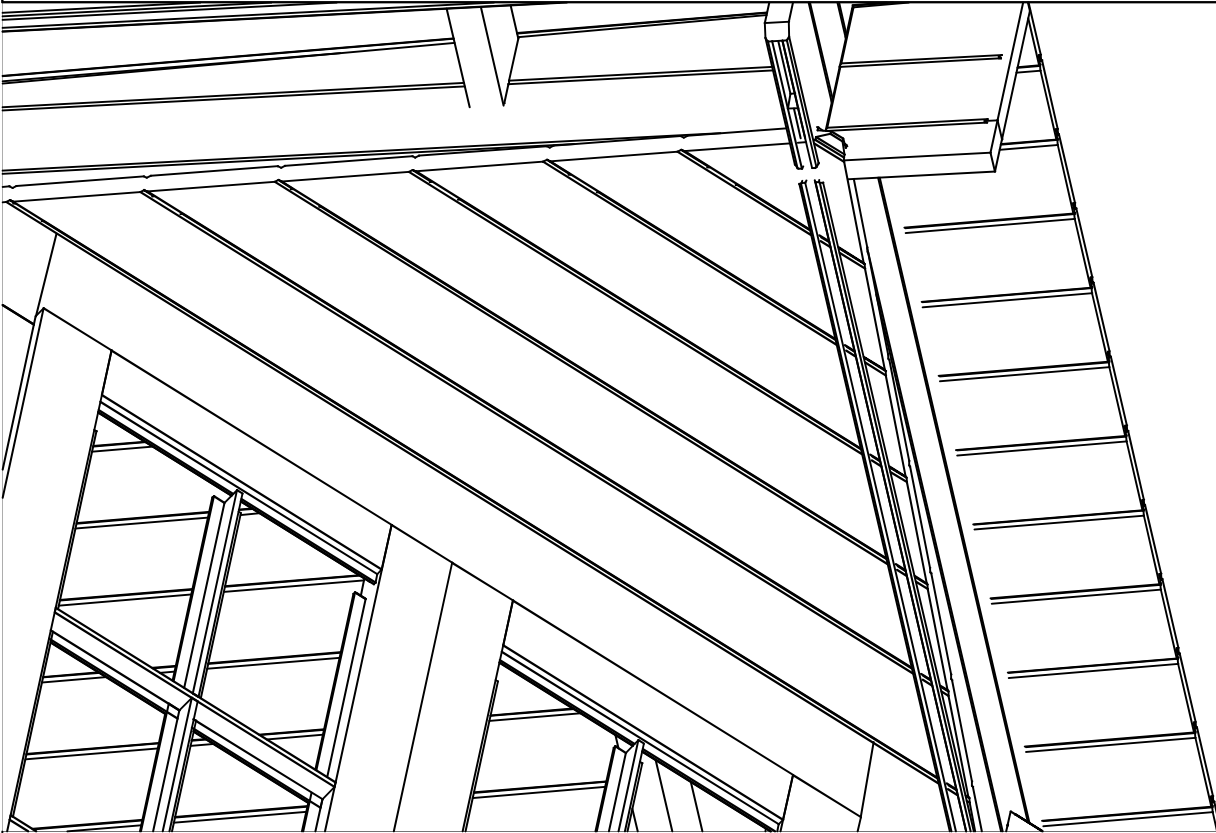

PACKAGE NR.:

MNFCT. ORDER NR.:

CONTROL 1

CONTROL 2

SIGNATURE

SIGNATURE

PAGE/PAGES: **7/7**

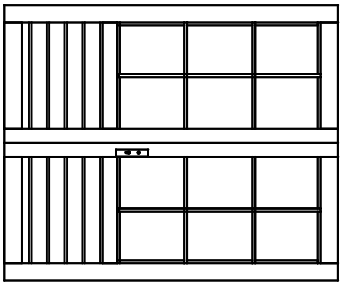

1

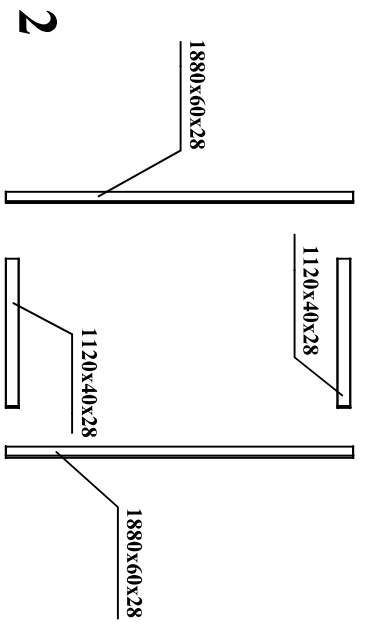

2

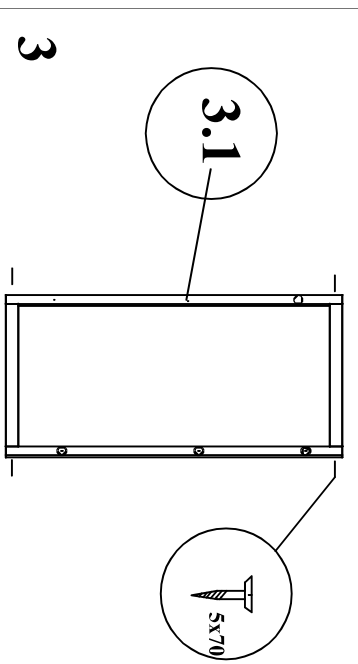

3

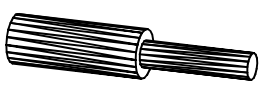

3.1

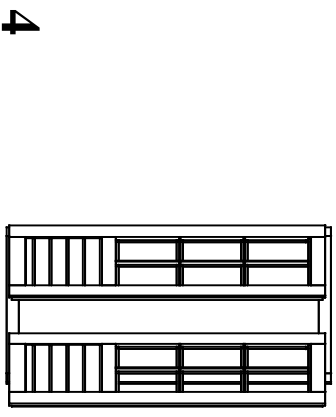

4

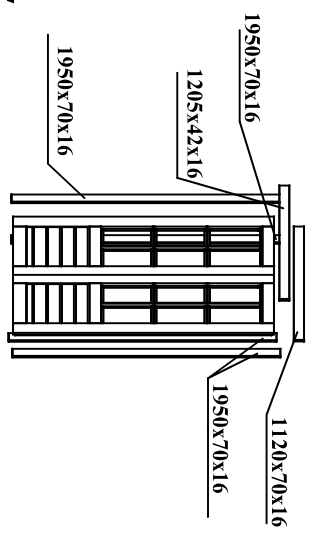

5

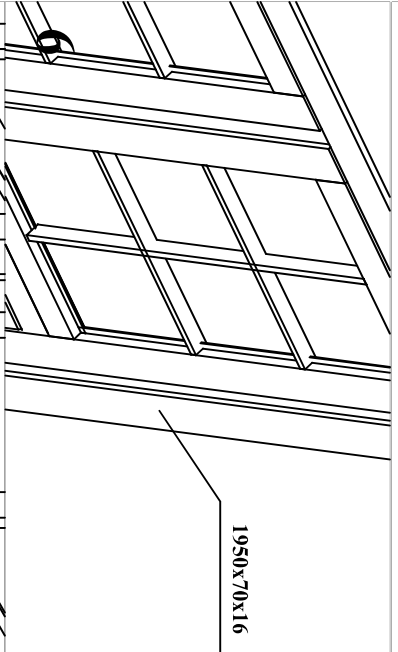

6

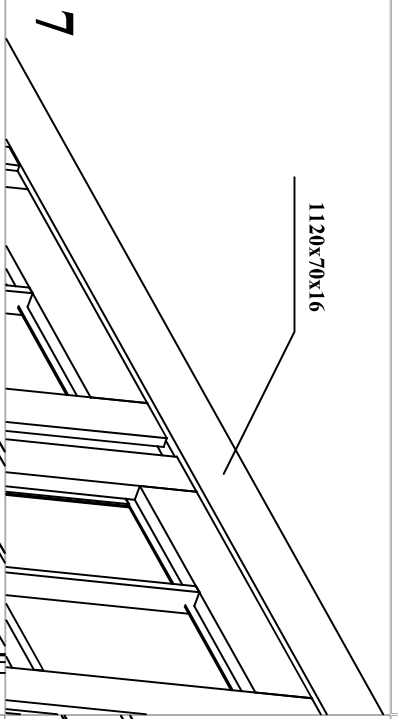

7

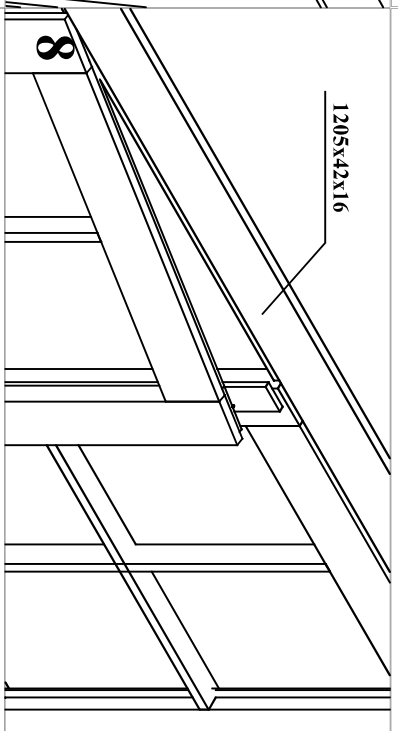

8

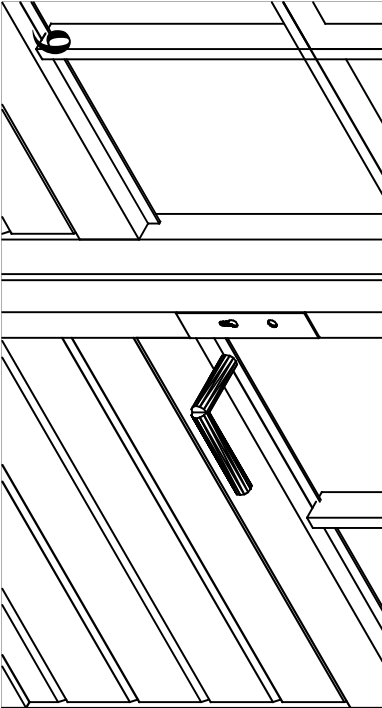

9

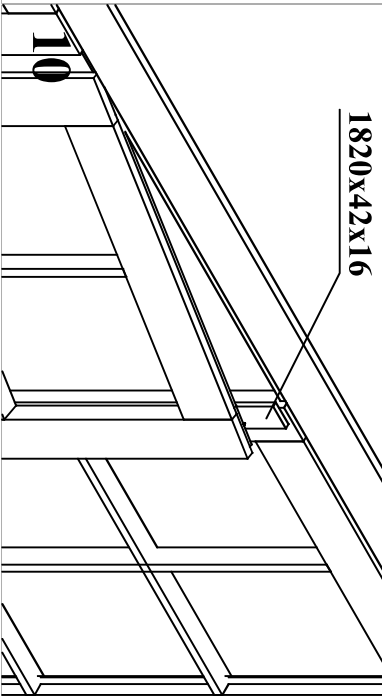

10

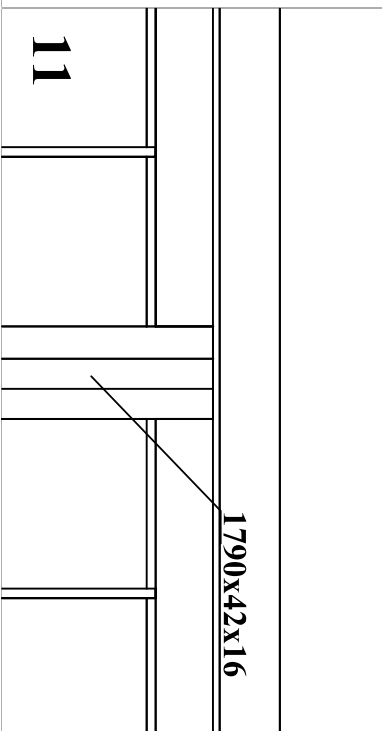

11