



















Pos	NEWCAASTLE 5,4 x 4,4 + 0,9 58x135	Profile	Length	St.	
C1 D1		58x135 	5300	2	
C2 D2			4930	2	
D3			4660	1	
C3			1397	1	
B2		58x135 	5400	15	
C4 D4			4400	19	
A3			5400	1	
C5			4400	1	
C6			1137	13	
A2			1060	28	
A1 B1			58 x 57	5400	2
A4 B4				5400	2
14	ROOFING BOARDS 	19 x 85	2880	126	
15	WINDOW	2126 x 966		1	
16	Block of doors	3280 x 1938		1	
18	Roof of cover fixture 	20x120 or 20x145	2930	4	
19	Roof of cover fixture 	20x95	2950	4	
26	Beam 	40x40	5300	2	
27	ROOF JOIST 	58x145	5300	5	
28	Diamond 			2	

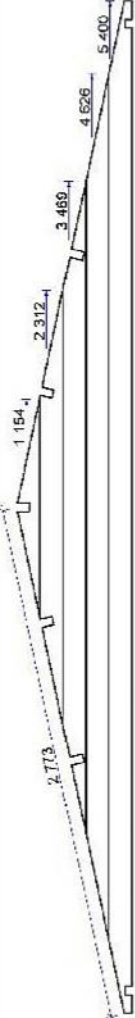

NEWCAASTLE 5,4 x 4,4 + 0,9 58\135 mm

Wall B

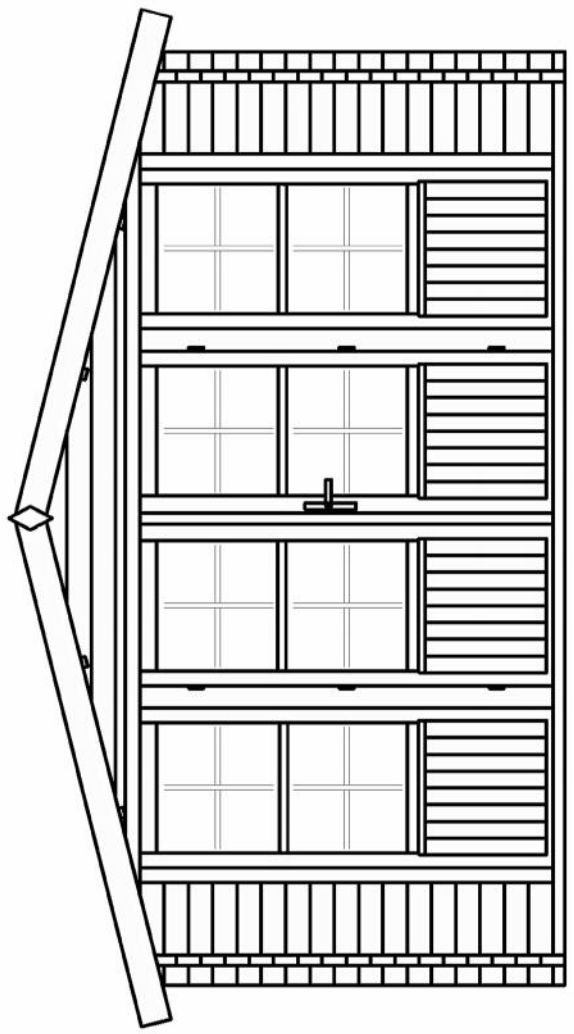
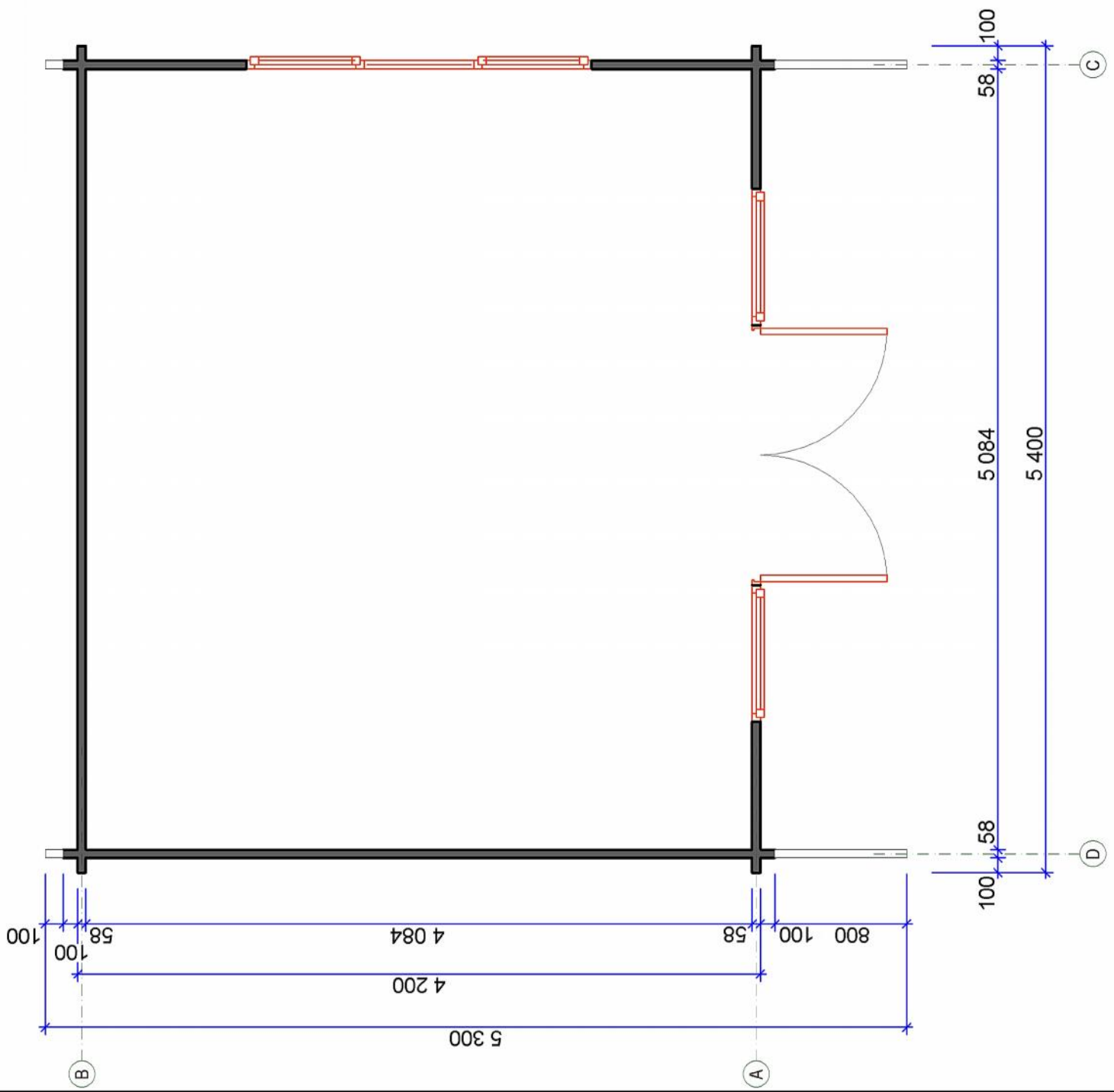
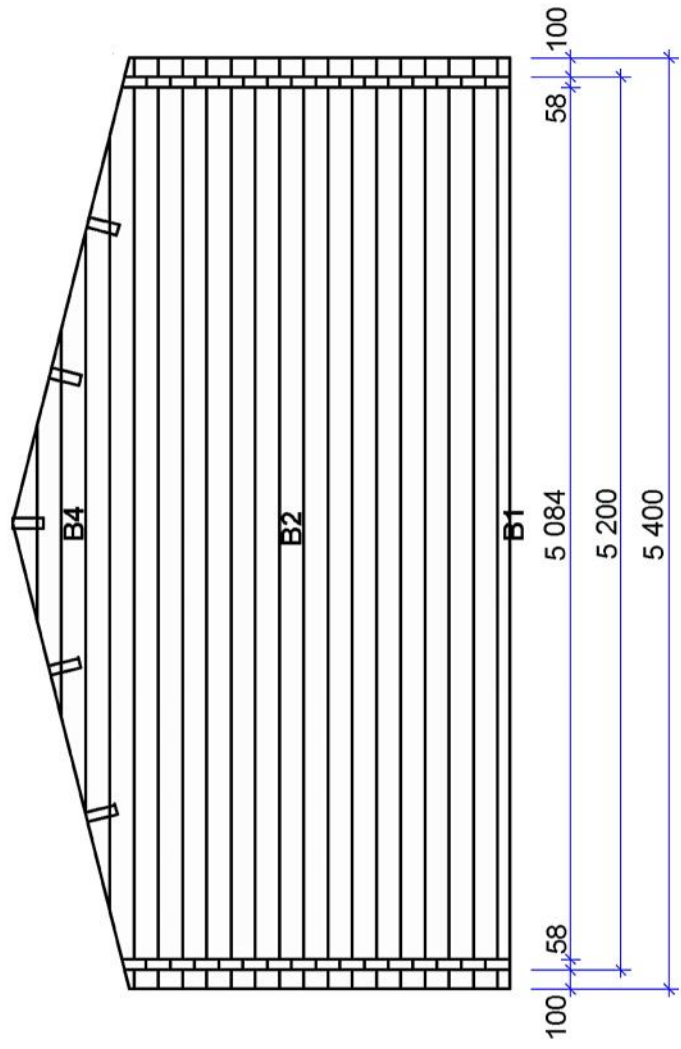

Wall A

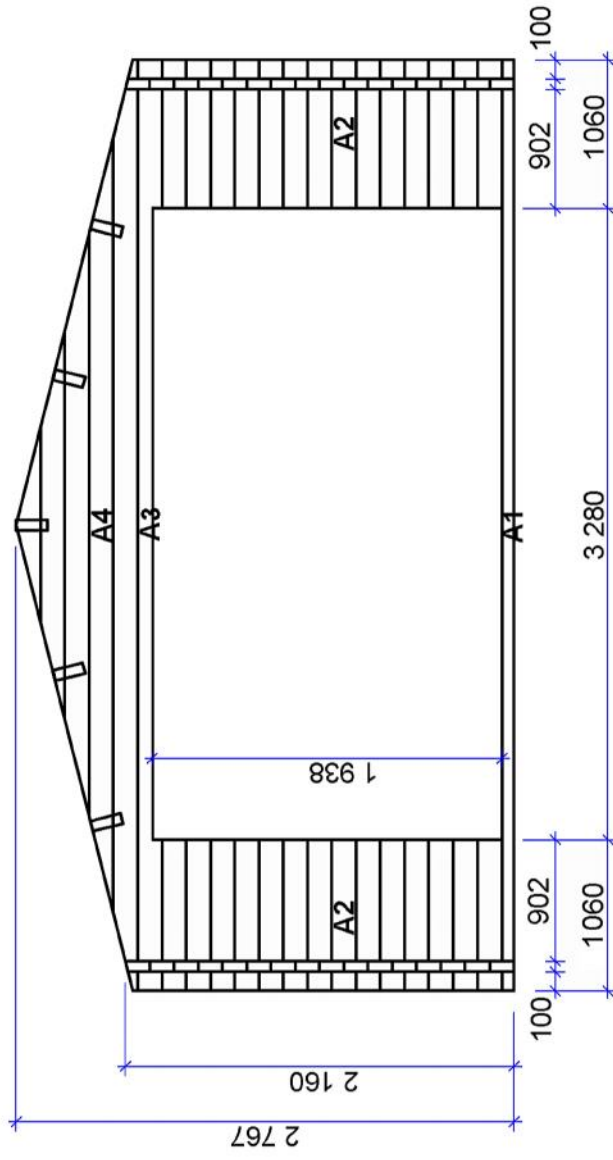

Wall C

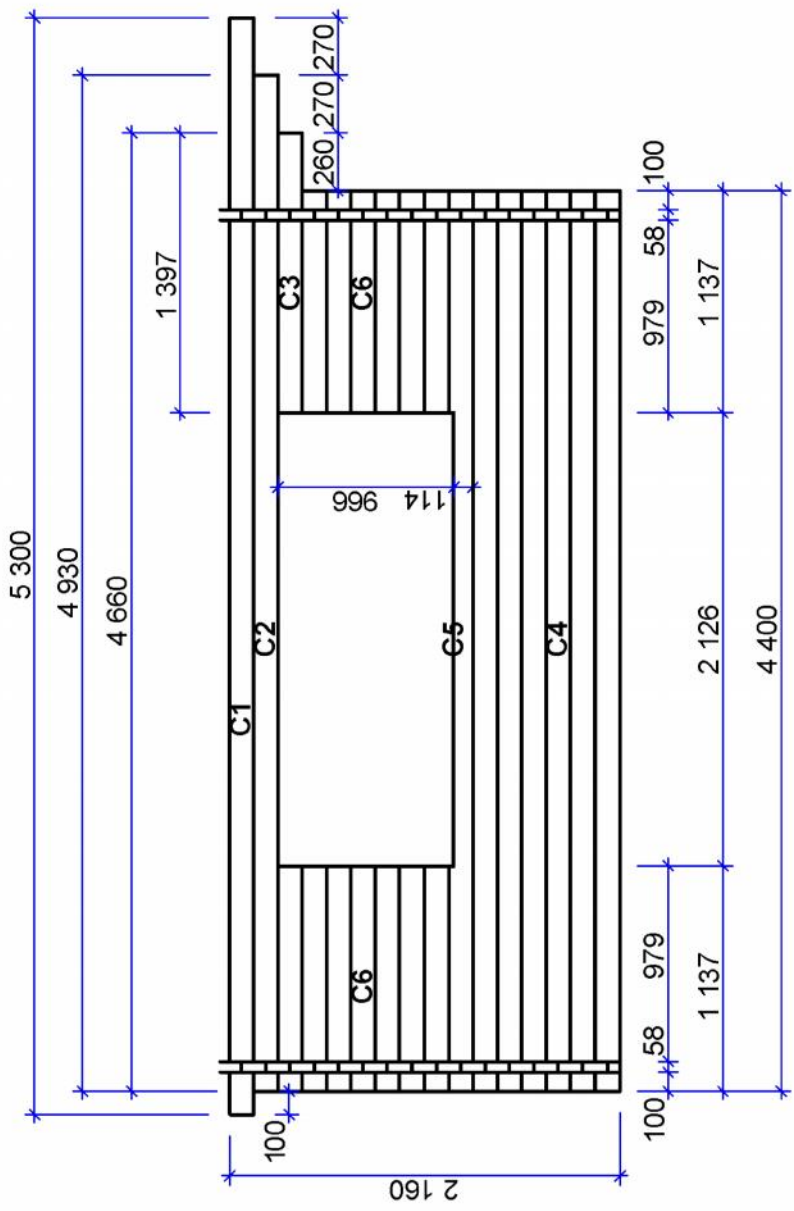

Wall D

