

Always keep the package number saved! Without package number there is no guarantee.

Package number:

BUILDING CODE

# NIKLAS

WALL LOG (mm): 28

SIZE (mm): 5760x2500

## COMPONENT SPECIFICATION

NUMBER	COMPONENT FUNCTION	COMPONENT CODE	VIEW	SIDE VIEW	DIMENSIONS (mm)			QUANTITY (psc.)
					LENGTH	WIDTH	THICKNESS	
1	Wall board	A1			1534	115	28	6
2	Wall board	A2			377	115	28	10
3	Wall board	A3			377	115	28	10
4	Wall board	A4			5760	115	28	1
5	Wall board	A5,B2			5760	115	28	2
6	Wall board	B1			5760	115	28	17
7	Wall board	C2			315	115	28	16
8	Wall board	C3,D5,E2			2500	115	28	19
9	Wall board	D2			1534	115	28	6
10	Wall board	D3			377	115	28	10
11	Wall board	D4			377	115	28	10
12	Wall board	C4,E3			2500	115	28	2
13	Wall board							
14	Wall board							
15	Wall board							
16	Wall board							
17	Wall board							
18	Wall board							
19	Wall board							
20	Wall board	C1			315	60	28	1
21	Wall board	D1			1534	60	28	1
22	Wall board	E1			2500	60	28	1
23	Apex	D6			2500		28	1
24	Bracer	C5			1880	40	28	1
25	Door	D-4			1880	1200		1
26	Window	W-1			1120	770		2
27	Column	A6			1890	100	60	1
28	Roof cover fixture				2800/3100	100	16	2/4
29	Roof board				3260	110	19	28
30	Beam				1905/1435 1400/820	60	40	4/6/6/8
31	Beam with octagon				3220	120	40	1

PACKAGE NR.:

MNFCT. ORDER NR.:

CONTROL 1

CONTROL 2

PAGE/PAGES:

**1/7**

SIGNATURE

SIGNATURE

BUILDING CODE

# Niklas

WALL LOG (mm): 28

SIZE (mm): 5760x2500

## ISOMETRIC VIEW

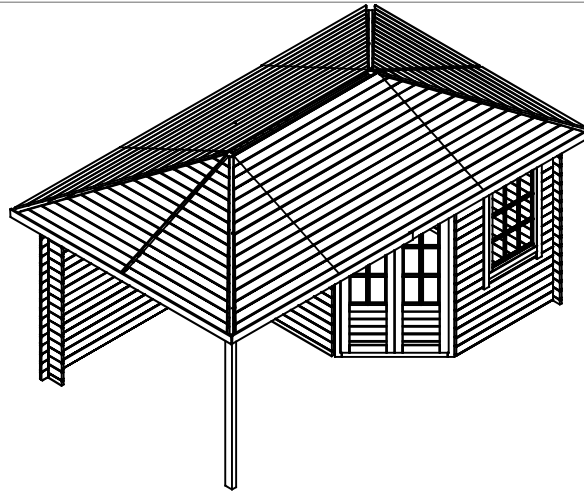
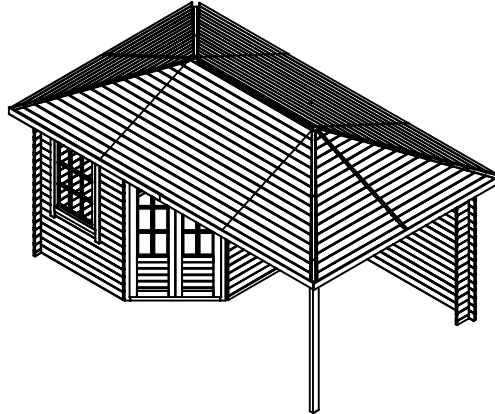

## TOP VIEW

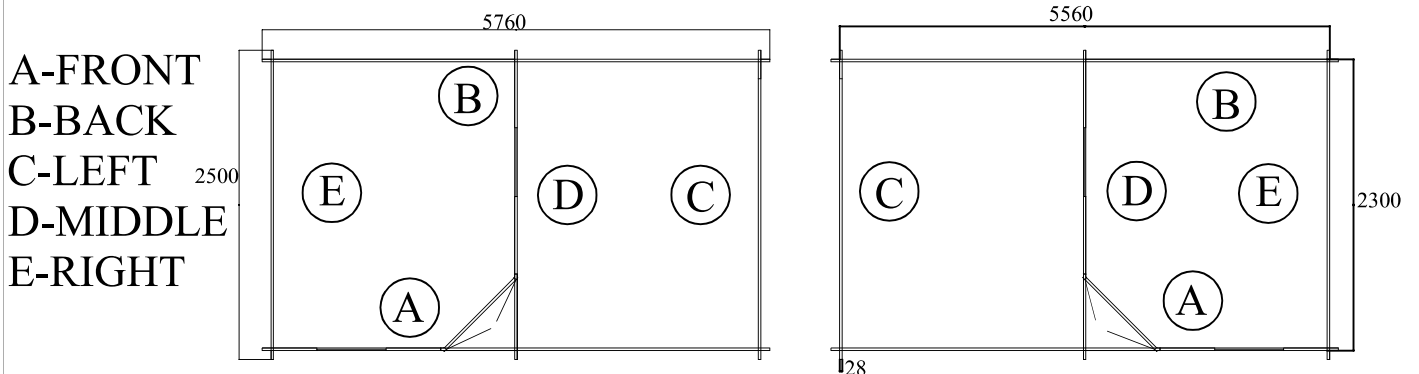

PACKAGE NR.:

MNFCT. ORDER NR.:

**CONTROL 1**

**CONTROL 2**

SIGNATURE

SIGNATURE

PAGE/PAGES: **2/7**

BUILDING CODE **NIKLAS**

WALL LOG (mm): 28

SIZE (mm): 5760x2500

## FRONT VIEW

(A)

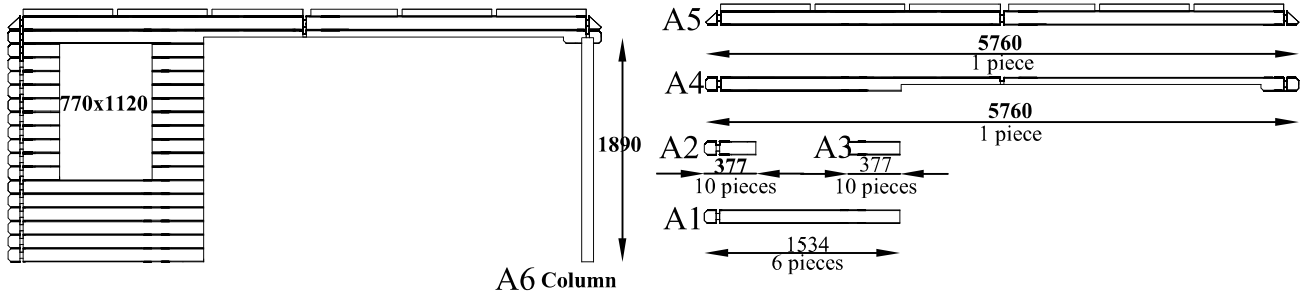

## BACK VIEW

(B)

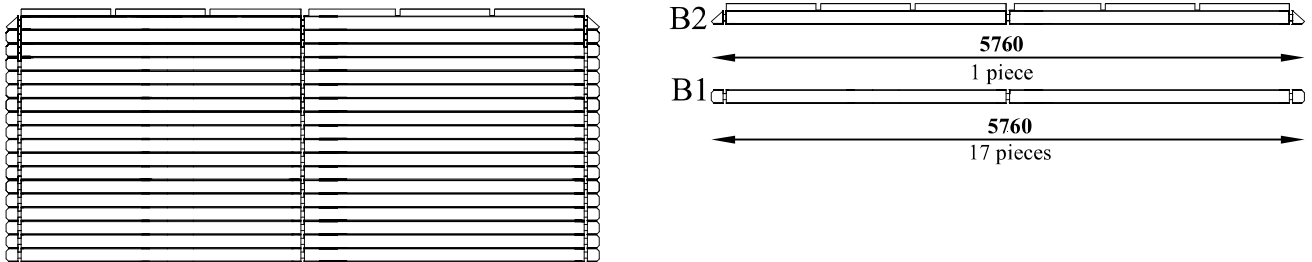

PACKAGE NR.:

MNFCT. ORDER NR.:

**CONTROL 1**

**CONTROL 2**

SIGNATURE

SIGNATURE

PAGE/PAGES: **3/7**

BUILDING CODE

**NIKLAS**

WALL LOG (mm): 28

SIZE (mm): 5760x2500

# LEFT VIEW

Ⓒ

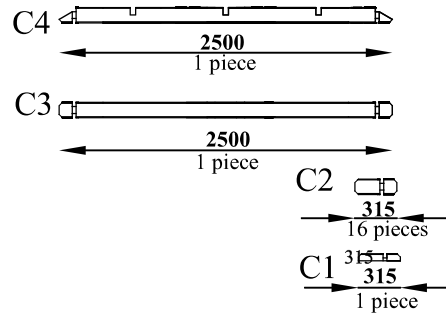
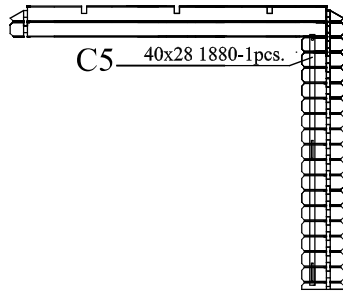

# MIDDLE VIEW

Ⓓ

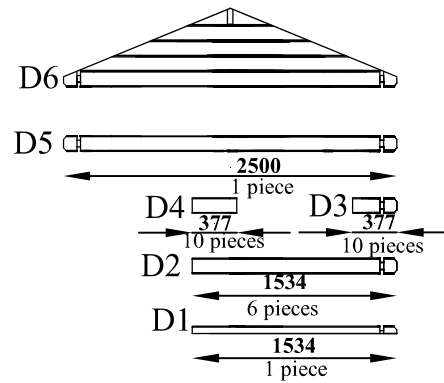
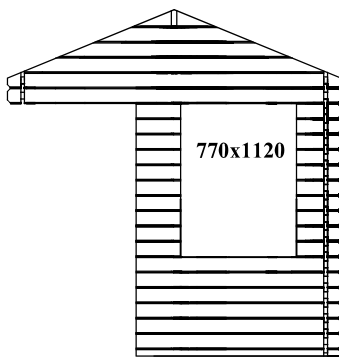

# RIGHT VIEW

Ⓔ

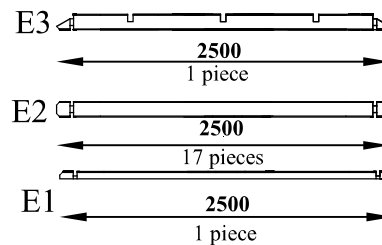
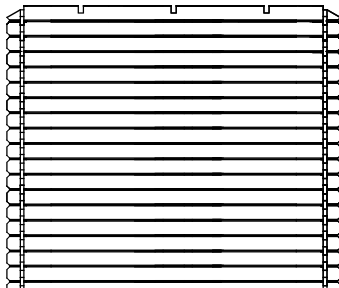

PACKAGE NR.:

MNFCT. ORDER NR.:

CONTROL 1

CONTROL 2

SIGNATURE

SIGNATURE

PAGE/PAGES:

**4/7**

BUILDING CODE **NIKLAS**

WALL LOG (mm): 28

SIZE (mm): 5760x2500

## CONSTRUCCION 1

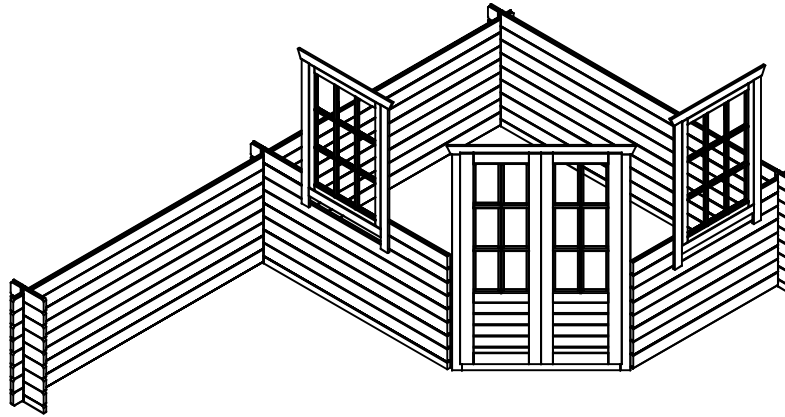

## CONSTRUCCION 2

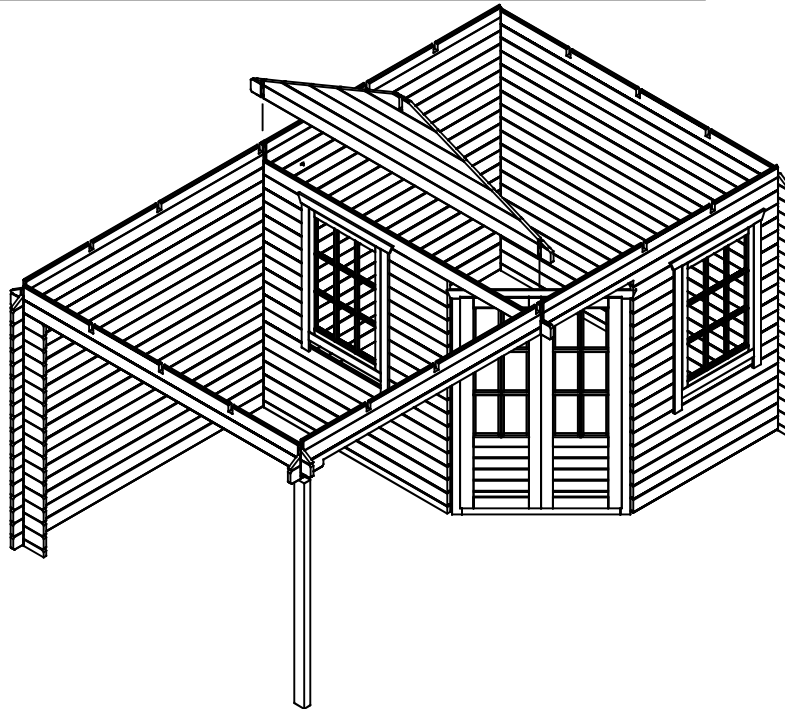

PACKAGE NR.:

MNFCT. ORDER NR.:

**CONTROL 1**

**CONTROL 2**

SIGNATURE

SIGNATURE

PAGE/PAGES: **5/7**

BUILDING CODE

**NIKLAS**

WALL LOG (mm): 28

SIZE (mm): 5760x2500

## CONSTRUCCION 3

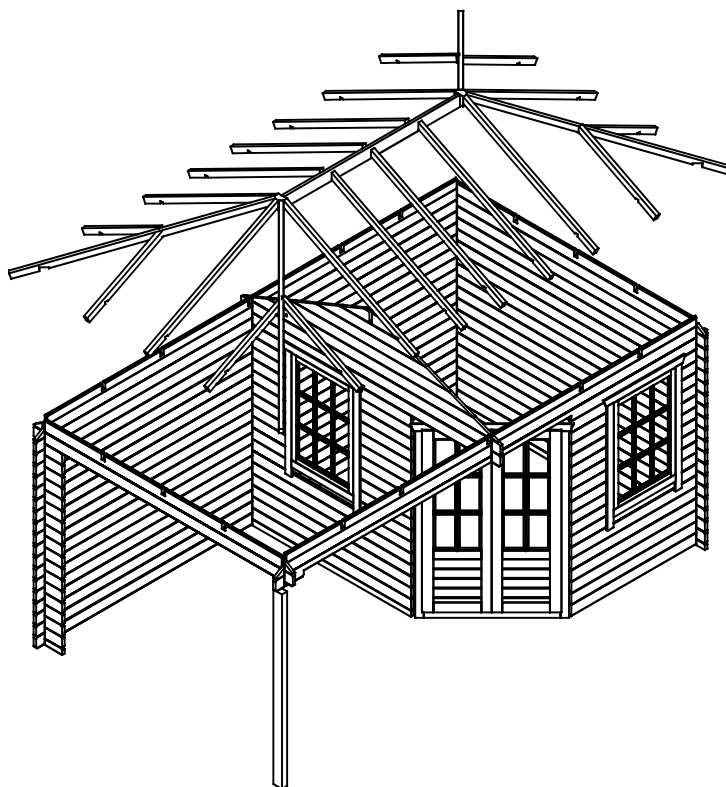

## CONSTRUCCION 4

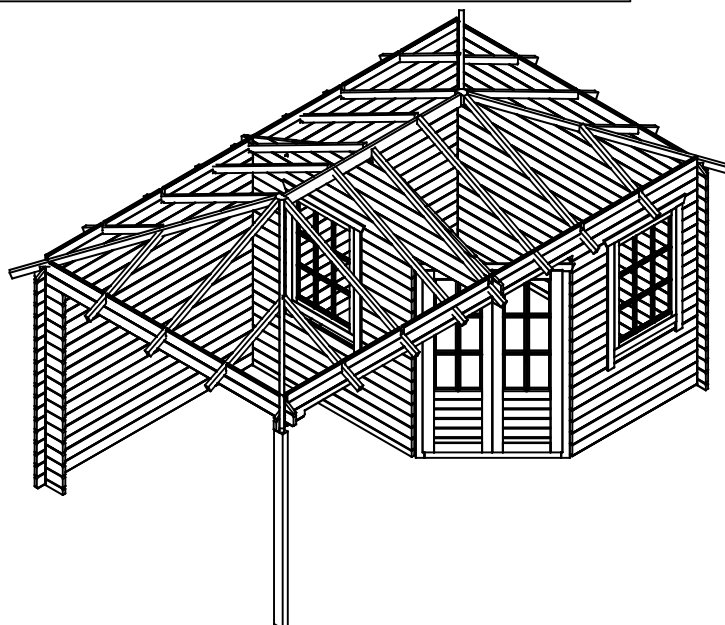

PACKAGE NR.:

MNFCT. ORDER NR.:

**CONTROL 1**

**CONTROL 2**

SIGNATURE

SIGNATURE

PAGE/PAGES:

**6/7**

BUILDING CODE

**NIKLAS**

WALL LOG (mm): 28

SIZE (mm): 5760x2500

# ISOMETRIC ROOF'S CONSTRUCTION

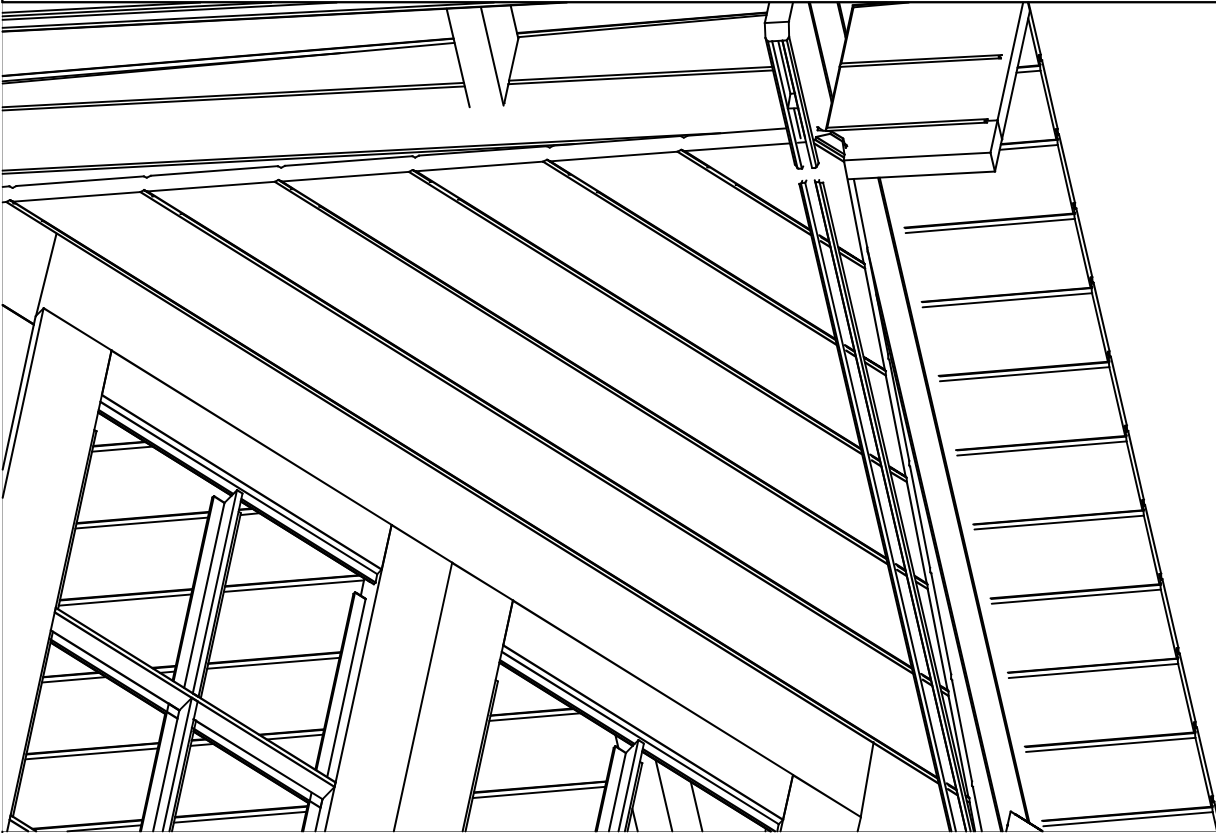

PACKAGE NR.:

MNFCT. ORDER NR.:

**CONTROL 1**

**CONTROL 2**

SIGNATURE

SIGNATURE

PAGE/PAGES: **7/7**

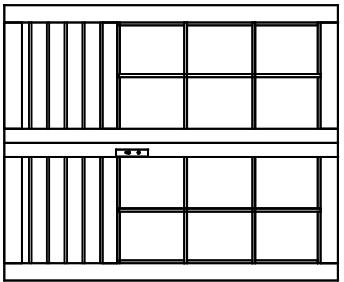

1

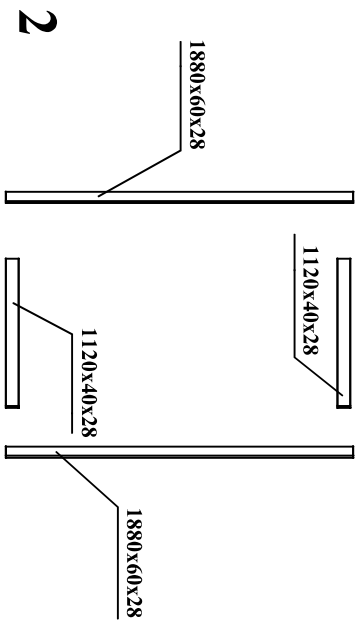

2

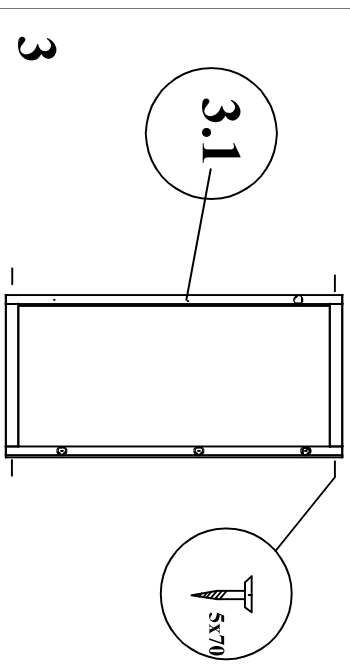

3

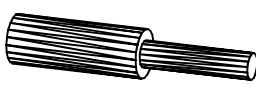

3.1

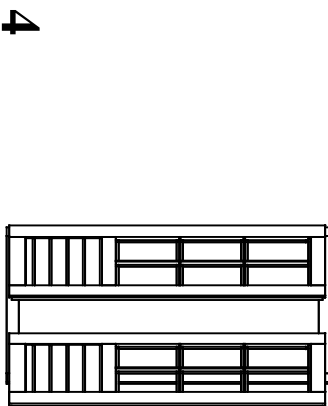

4

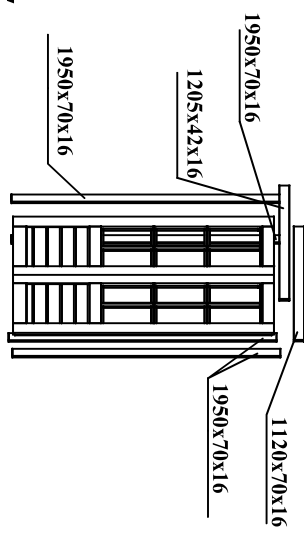

5

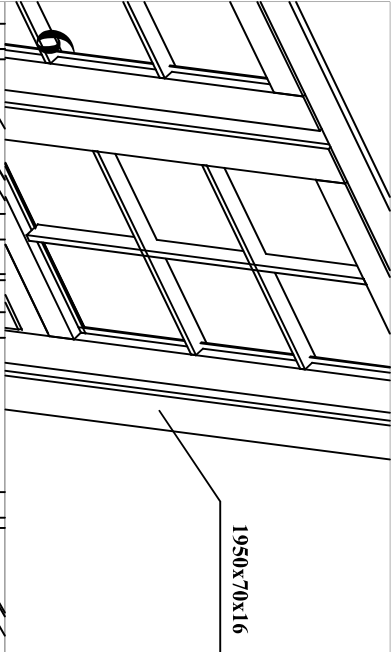

6

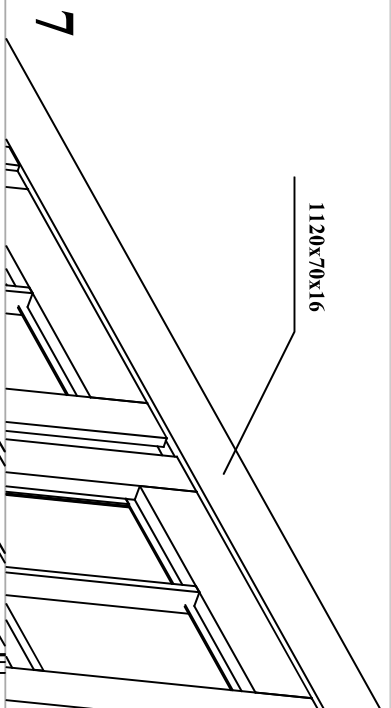

7

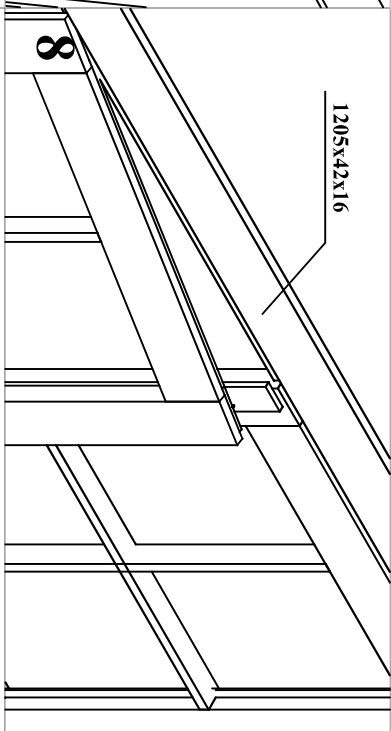

8

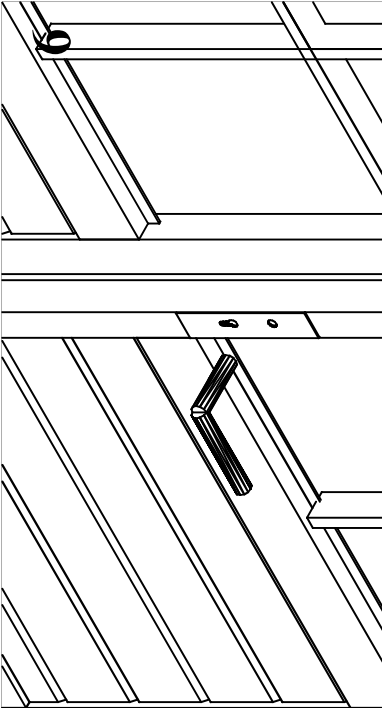

9

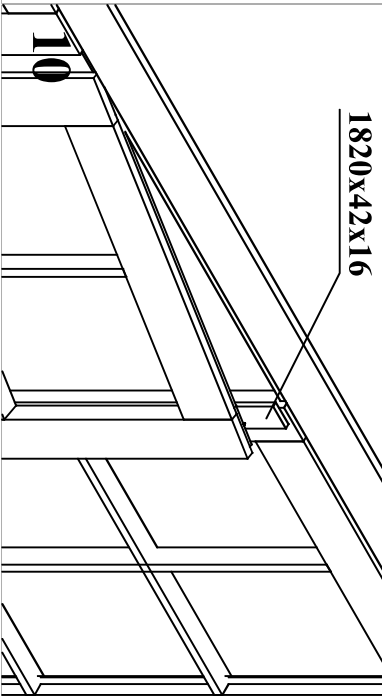

10

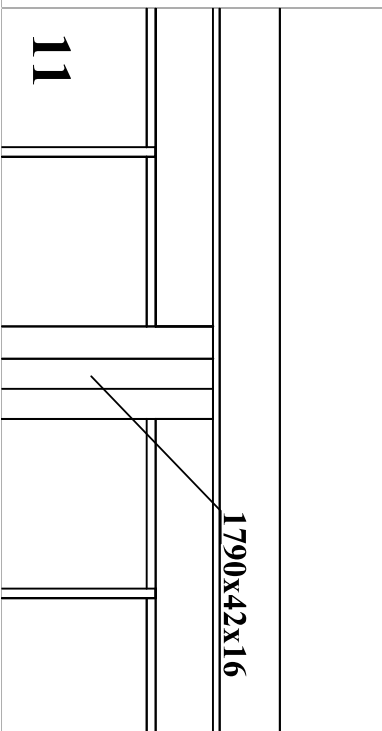

11