

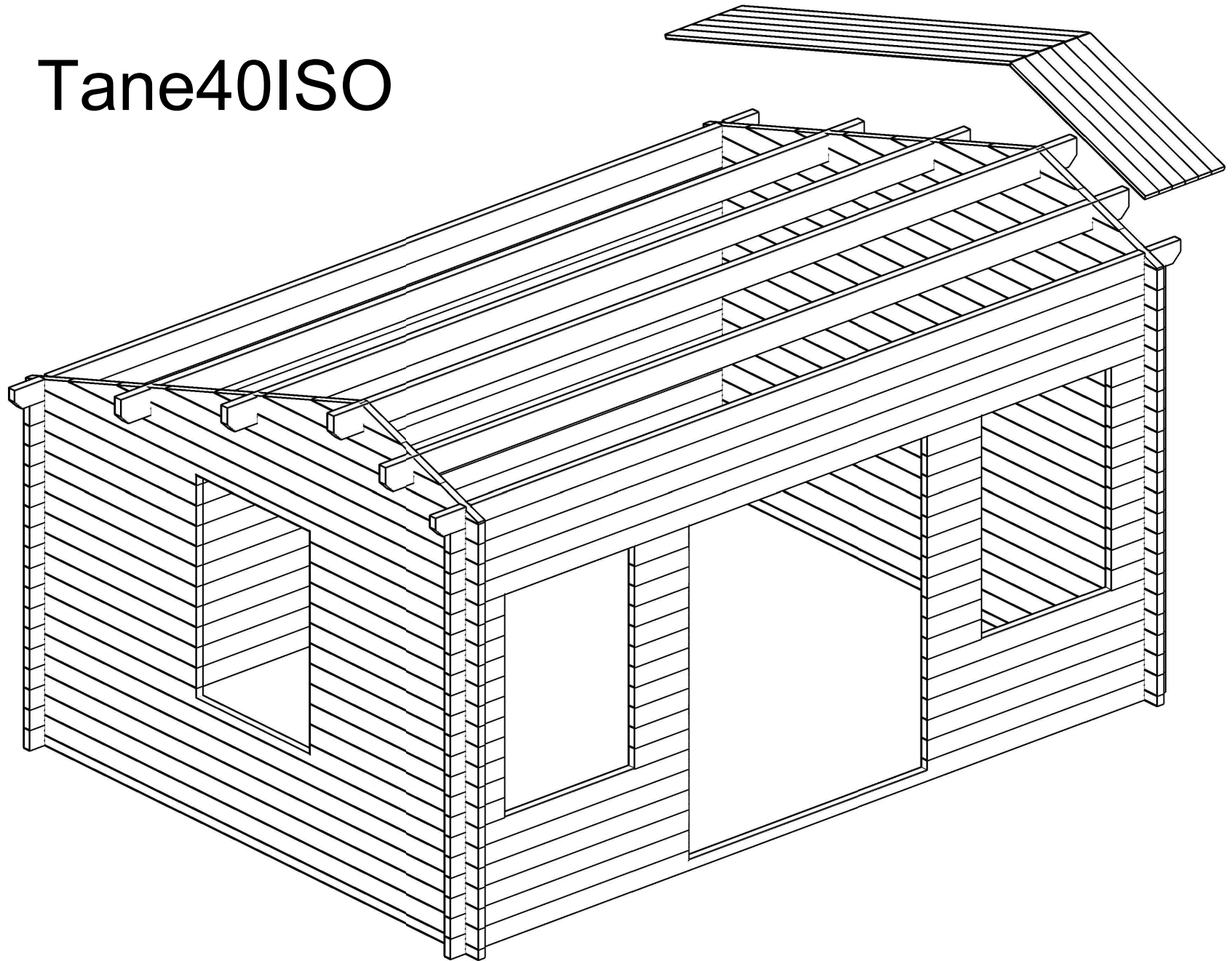

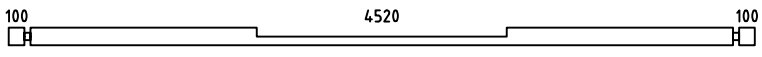

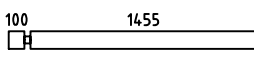





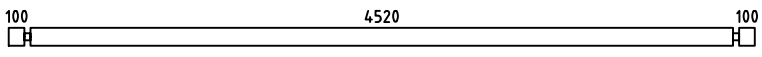
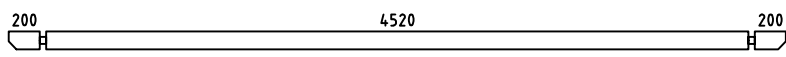
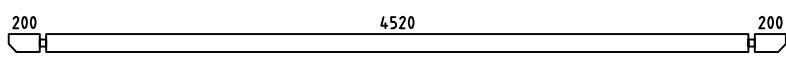
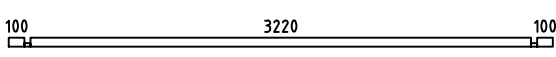
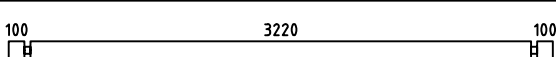
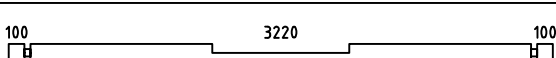
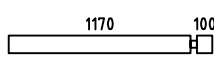
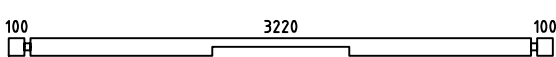
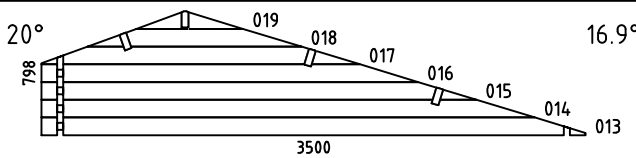
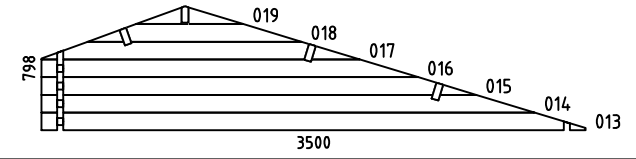
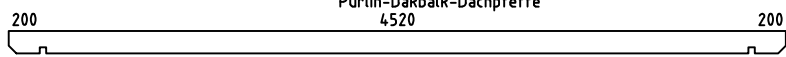
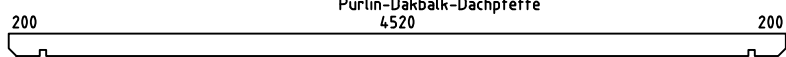

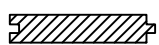
# Tane40ISO

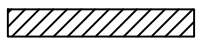
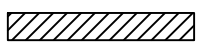

Pos	Specification-Spezifikation-Specificatie	St.	Profile (mm)	Length (mm)
001		1	40x114	4800
002		10	40x114	1595
003		22	40x114	360
004		22	40x114	360
005		21	40x114	4800
006		1	40x114	5000
007		1	40x114	5000
008		2	40x57	3500
009		22	40x114	3500
010		1	40x114	3500
011		20	40x114	1310
012		1	40x114	3500
WA-1		1		
WB-1		1		
PR1		3	44x144	5000
PR2		1	44x144	5000
DP-1	Roof board-Dachbrett-Dakplank 	57	88x18	2800
DP-2	Roof board-Dachbrett-Dakplank 	57	88x18	1100
L-1	Eave Slat-Traufenteiste-Afdekljst 	2	40x18	5000
L-2	Facia Board-Giebelblende-Gevelplank 	2	18x120	1140
L-3	Facia Board-Giebelblende-Gevelplank 	2	18x120	2840
L-4	Facia Slat-Giebelleiste-Gevellijst 	2	40x18	1140
L-5	Facia Slat-Giebelleiste-Gevellijst 	2	40x18	2840
Code	GartenHaus GmbH	Material	File Tane40ISO.dwg	Page

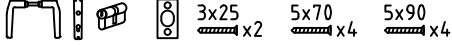
Pos	Specification-Spezifikation-Specificatie	St.	Profile (mm)	Length (mm)
D1	Diamond 	2		
	Double Door Set ISO-Doppeltür Satz-Dubbele Deur Set 	1		
	Nail-Nagel-Spijker 1.2x20 	35	1.2x20	
	Window Handle Set-Fenstergriff Satz-Raamgreep Set 	3		
W6DK 86.5x 122.5 L	WINDOW 865x1225 ISO  Window Glazing Bar Fenstersprossen Raamroeden	1		
W6DK 86.5x 122.5 R	WINDOW 865x1225 ISO  Window Glazing Bar Fenstersprossen Raamroeden	2		
DD6 1 60x18 5 ISO	DOOR 1600x1850 ISO  Door Glazing Bar Türsprossen Deurroeden	1		
Code	GartenHaus GmbH	Material	File	Tane40ISO.dwg
				Page

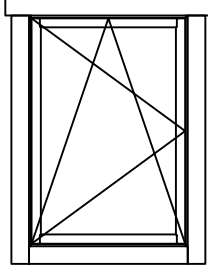
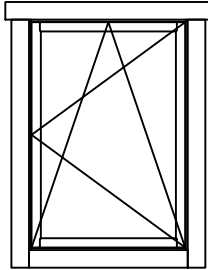
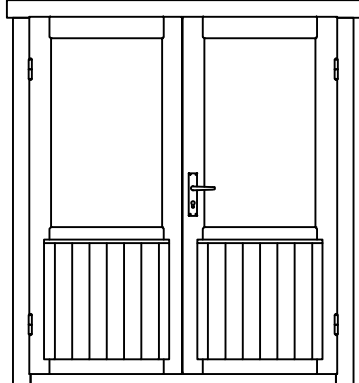
H = 1.500 m  
 TOTAL: 14.55 m<sup>2</sup>

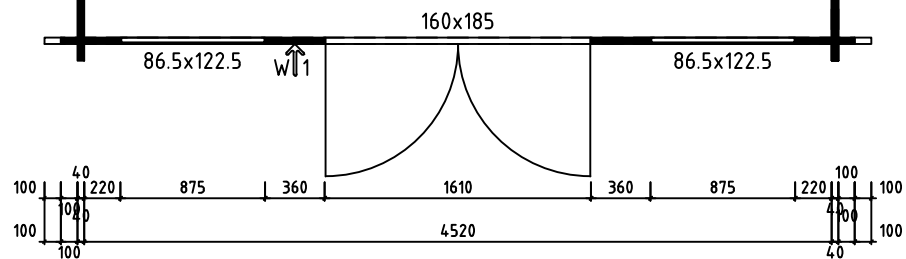
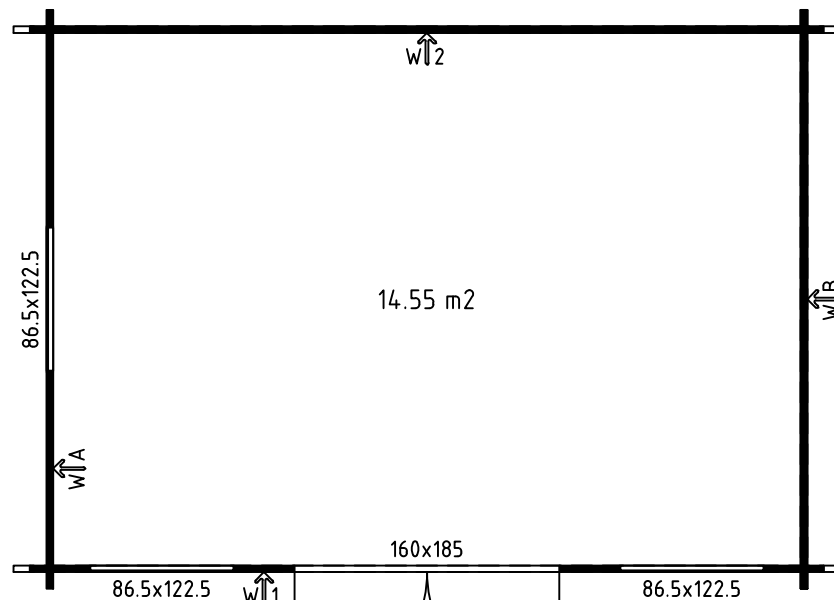
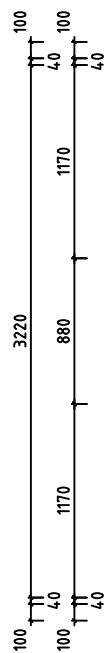
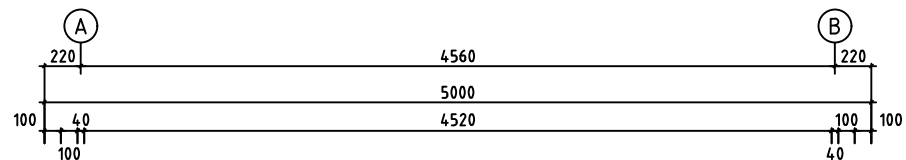

Model	Tane40ISO	Page	PLAN
Client		Scale	1:40
Material	4.0x114	Date	01.11.2019
Company		File	Tane40ISO.dwg

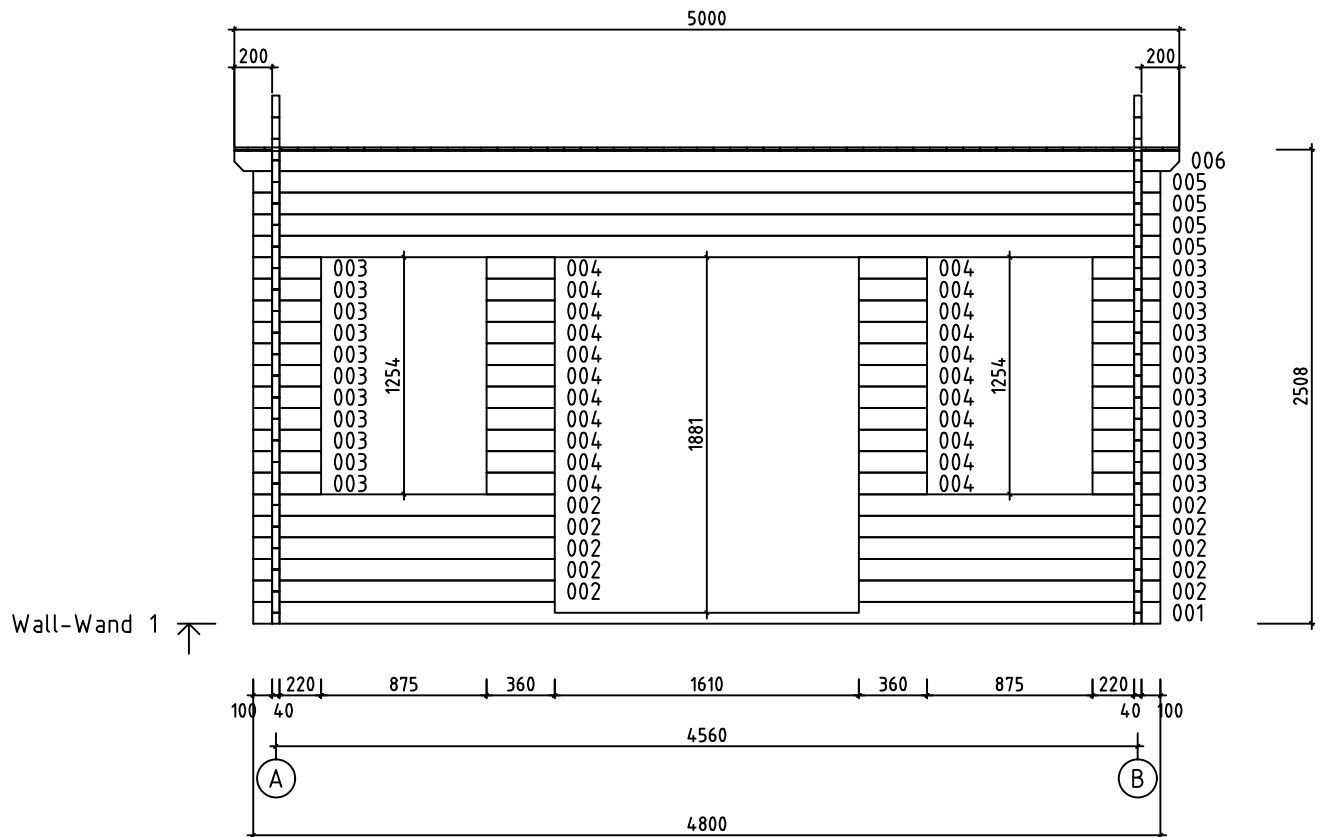

Model	Tane40ISO	Page	4
Client		Scale	1:40
Material	4x11.4	Date	01.11.2019
Company		File	Tane40ISO.dwg

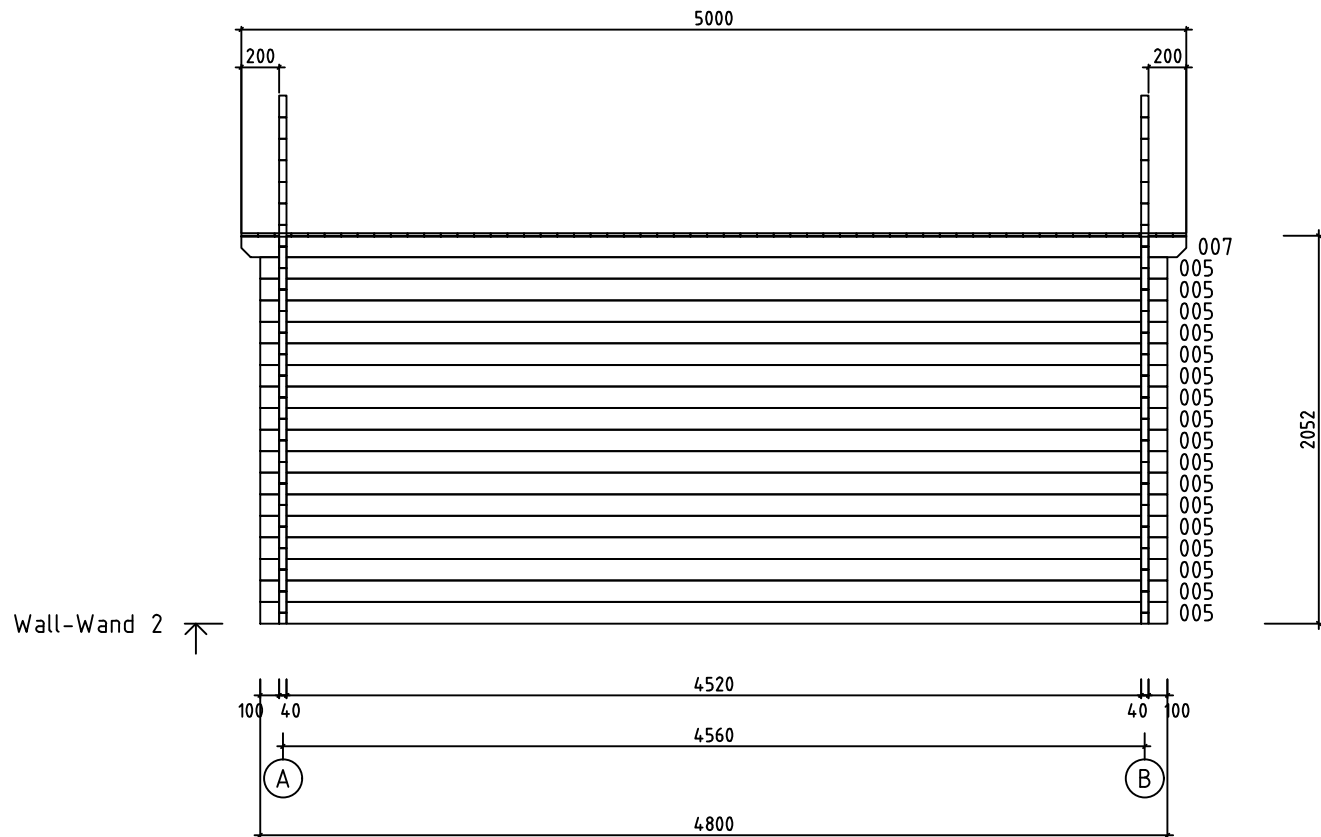

Wall-Wand 2 ↗

Model	Tane40ISO	Page	5
Client		Scale	1:40
Material	4x11.4	Date	01.11.2019
Company		File	Tane40ISO.dwg

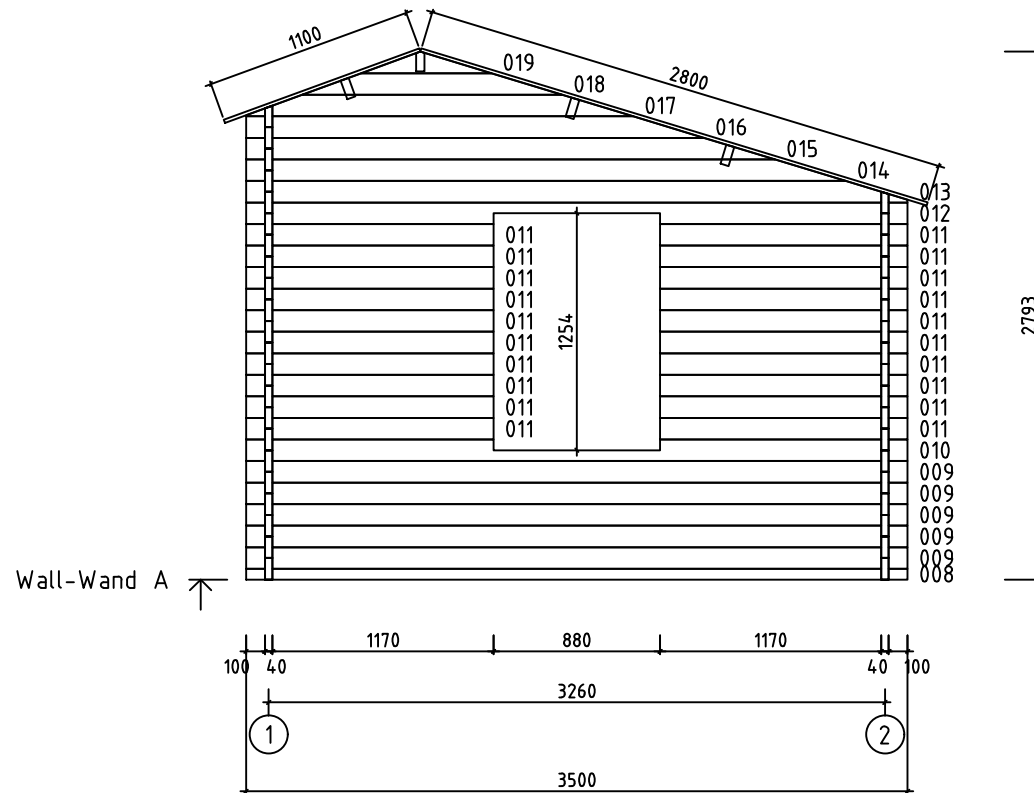

Model	Tane40ISO	Page	2
Client		Scale	1:40
Material	4x11.4	Date	01.11.2019
Company		File	Tane40ISO.dwg

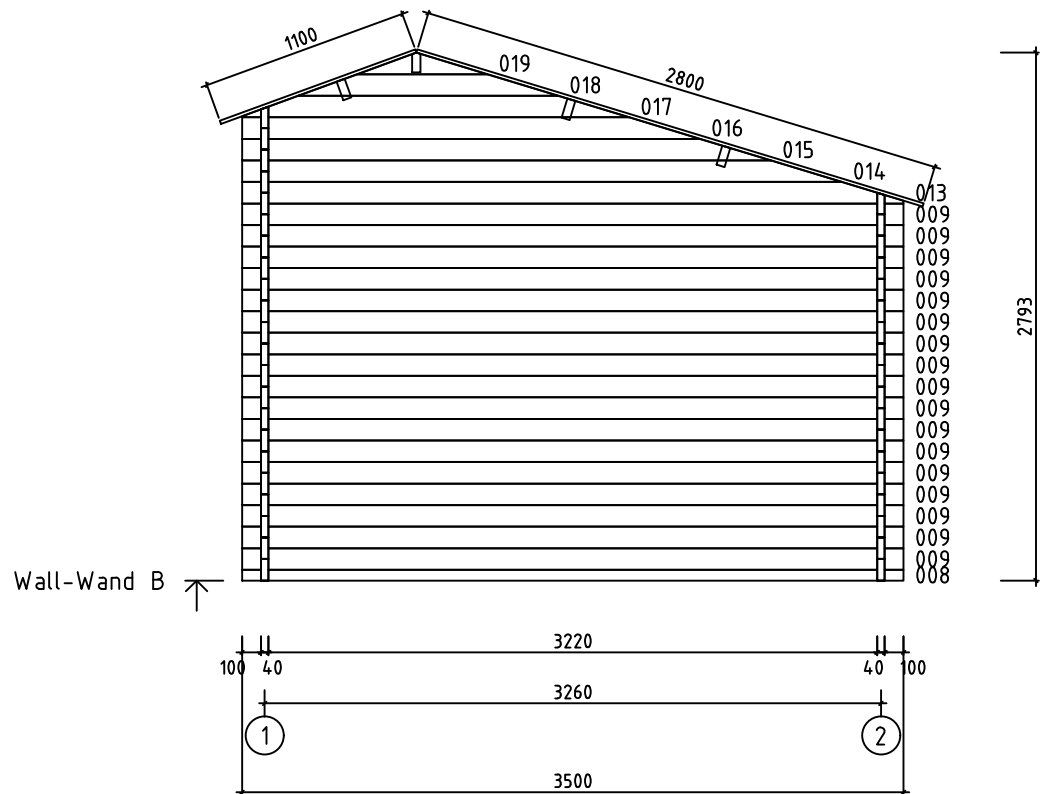

Model	Tane40ISO	Page	3
Client		Scale	1:40
Material	4x11.4	Date	01.11.2019
Company		File	Tane40ISO.dwg



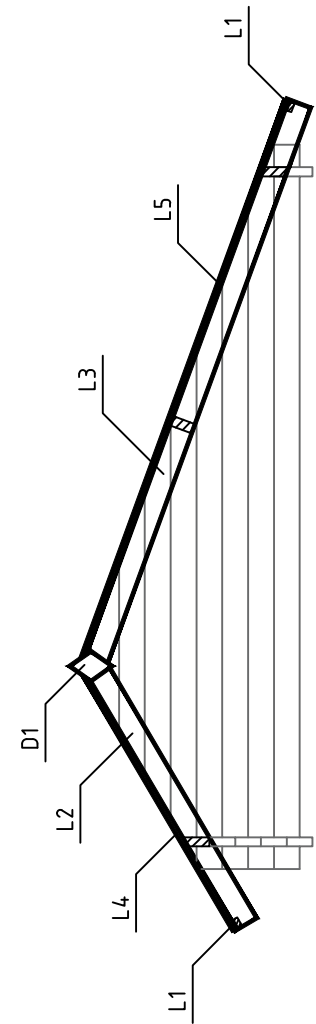
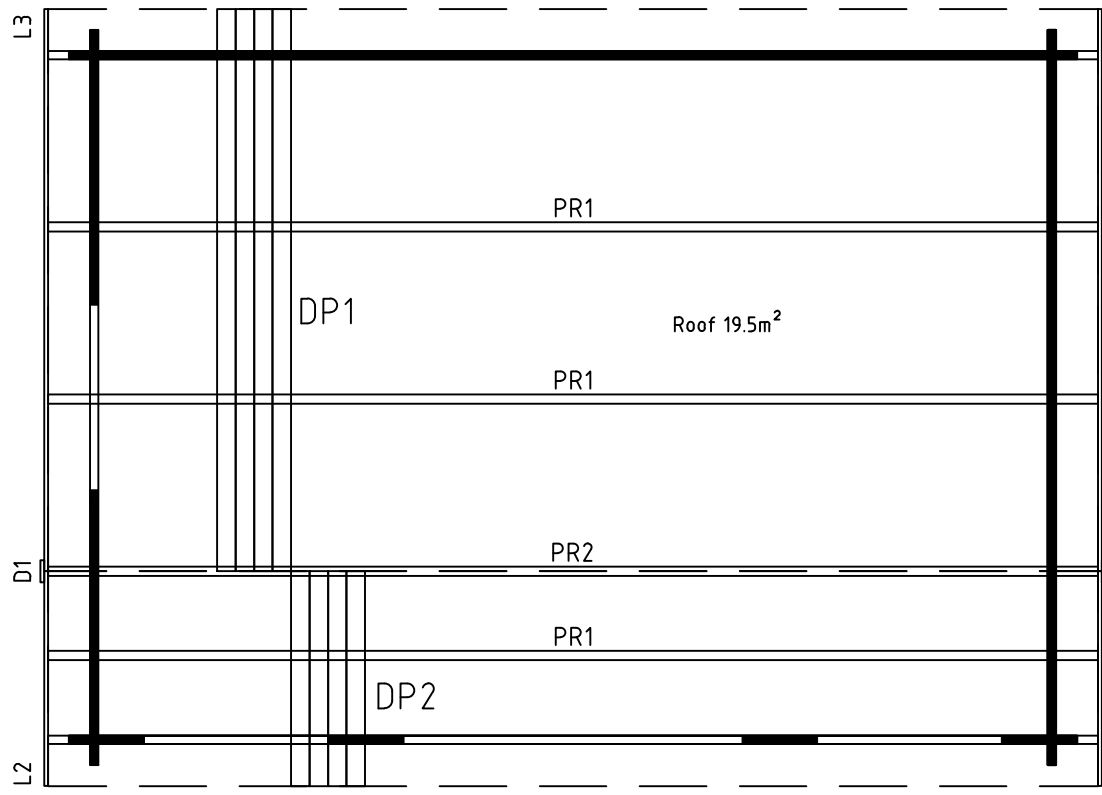

Model	Tane40ISO	Page	ROOF
Client		Scale	1:40
Material	40x114	Date	01.11.2019
Company		File	Tane40ISO.dwg

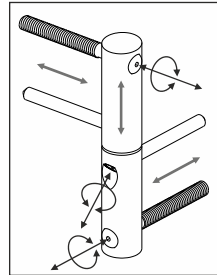
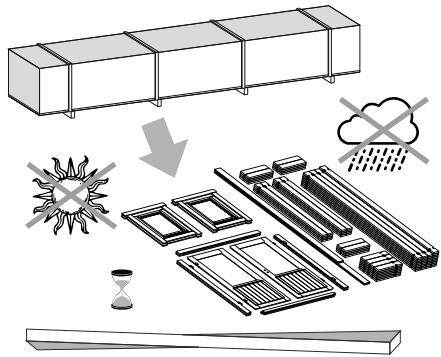
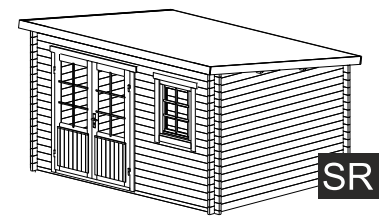
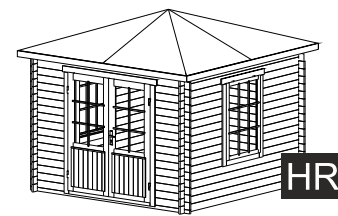
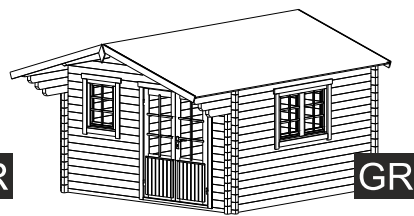
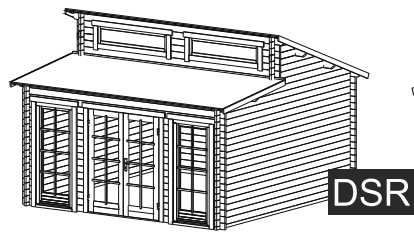
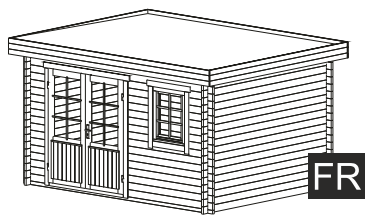

ADJUSTABLE HINGES

3.

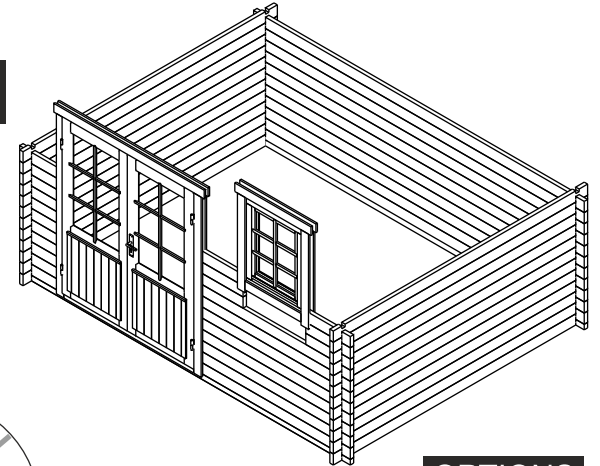

1.

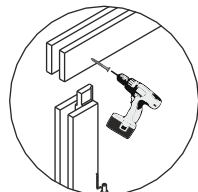
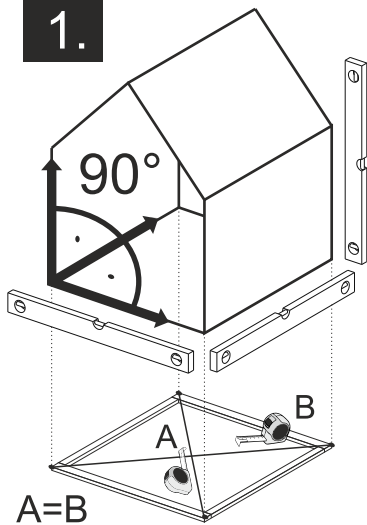

TYPE- B  
4x60

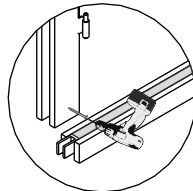

TYPE- A  
5x70

2.

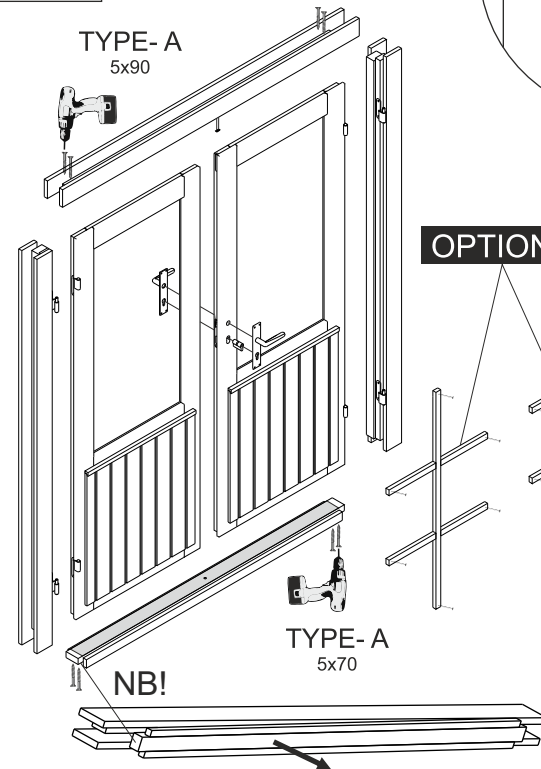

OPTIONS



1. 2.

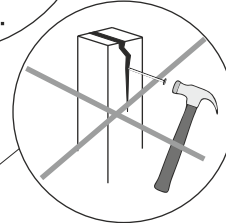

OPTIONS

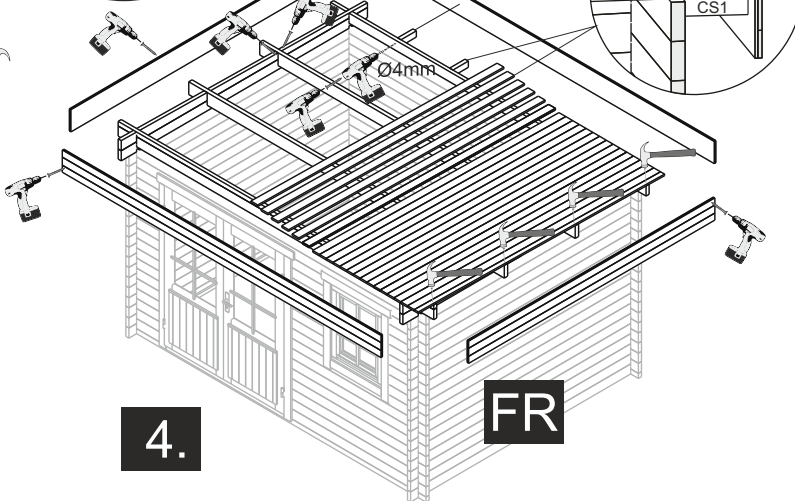
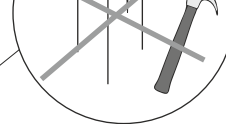

4.

FR

The guide is illustrative. This guide is not project specification.  
Der Leitfaden ist illustrativ. Dieser Leitfaden ist keine Projektspezifikation.  
De gids is illustratief. Deze gids is geen projectspecificatie.

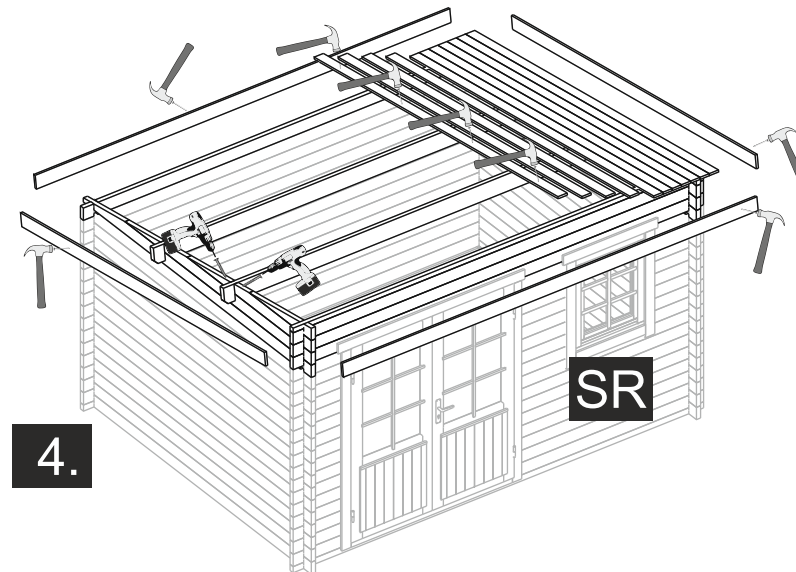
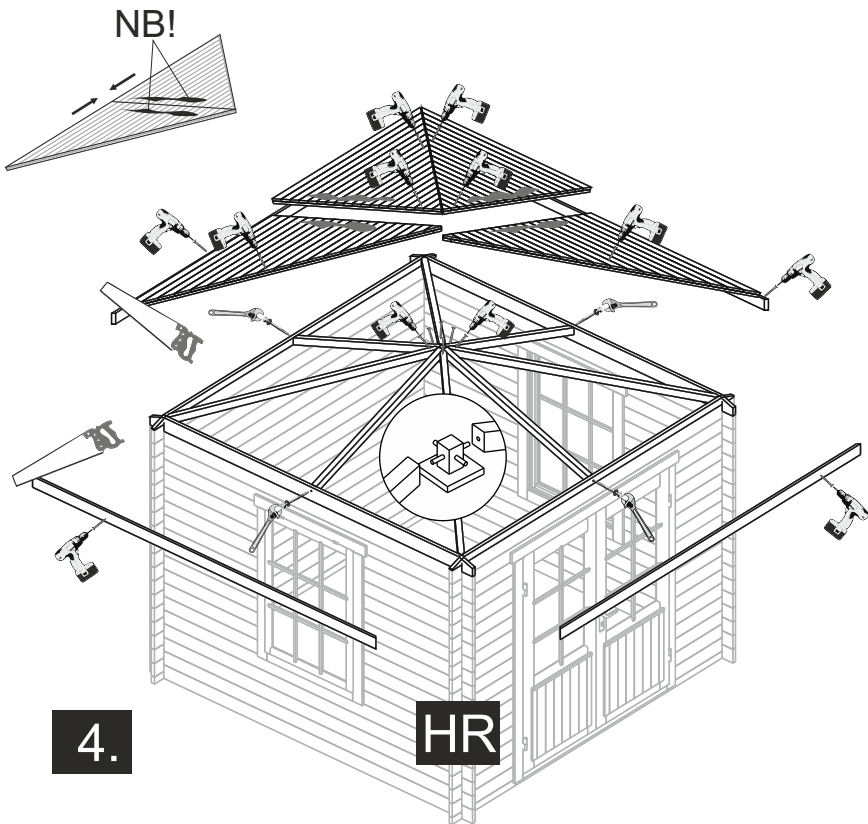
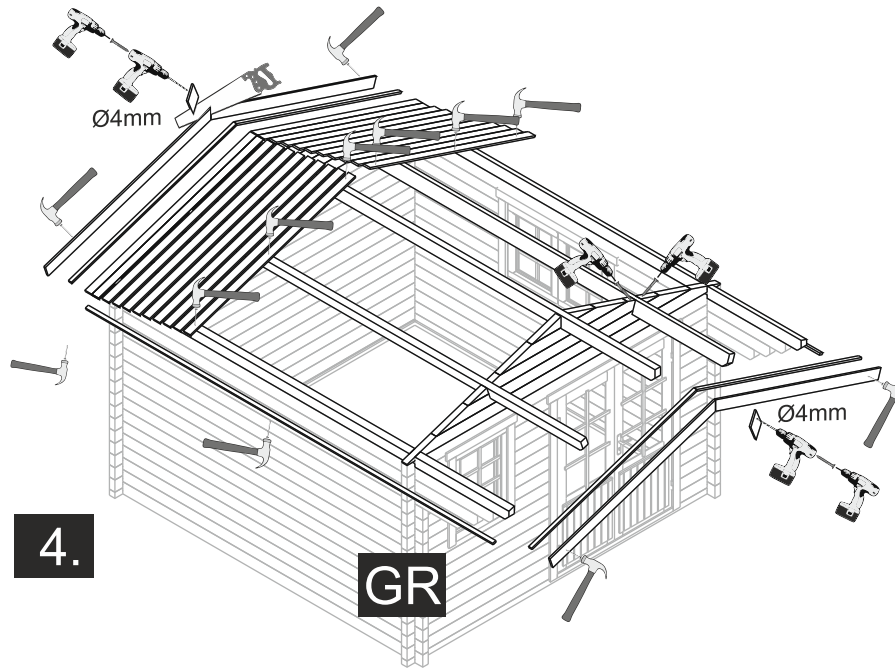
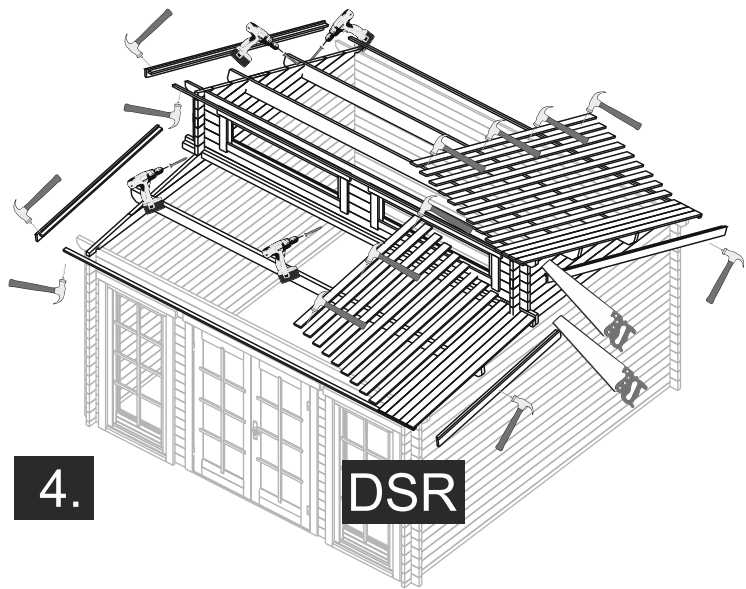

**OPTIONS**

