

BUILDING CODE

TORSTEN

WALL LOG (mm): 58

SIZE (mm): 5950x4000

CONSTRUCTION 1

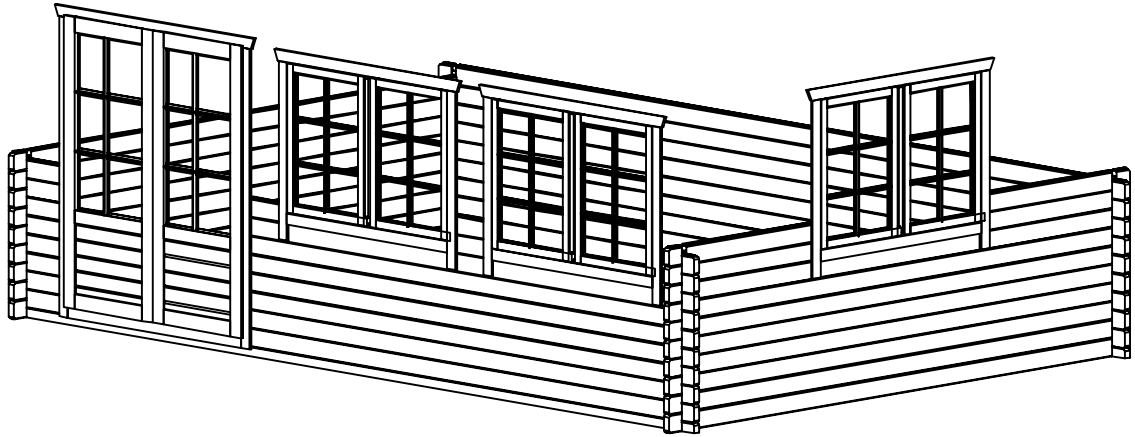

CONSTRUCTION 2

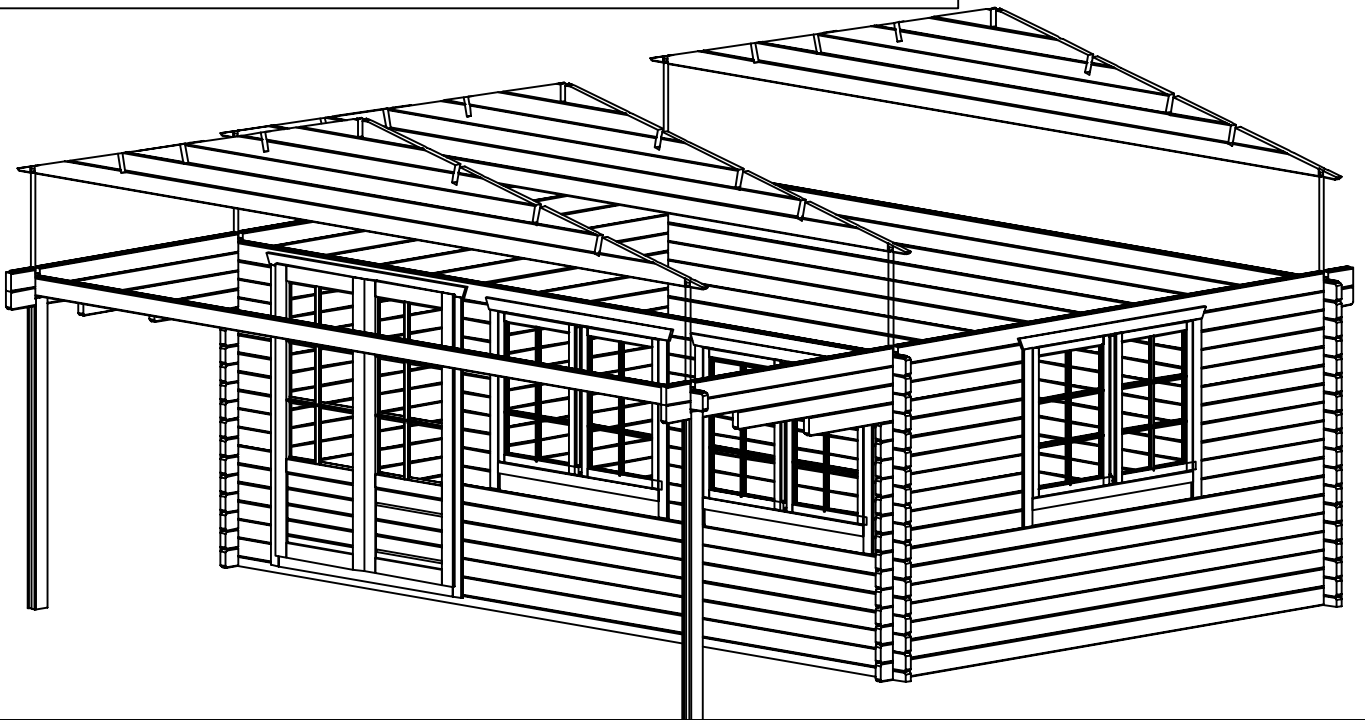

PACKAGE NR.:

MNFCT. ORDER NR.:

CONTROL 1

CONTROL 2

SIGNATURE

SIGNATURE

PAGE/PAGES: **5/8**

BUILDING CODE

TORSTEN

WALL LOG (mm): 58

SIZE (mm): 5950x4000

LEFT VIEW

(C)

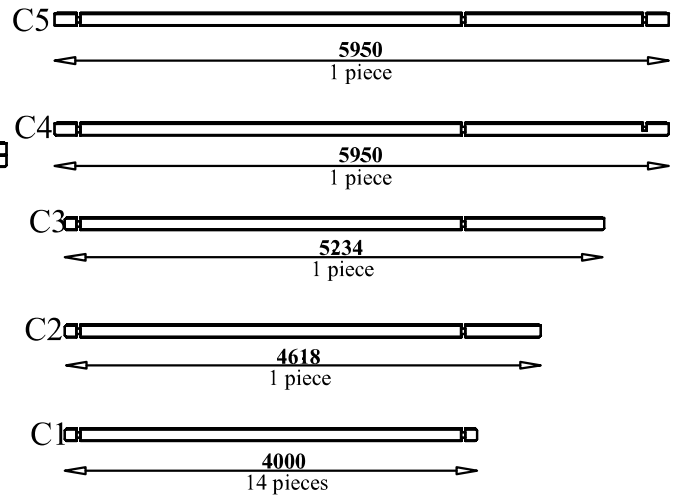
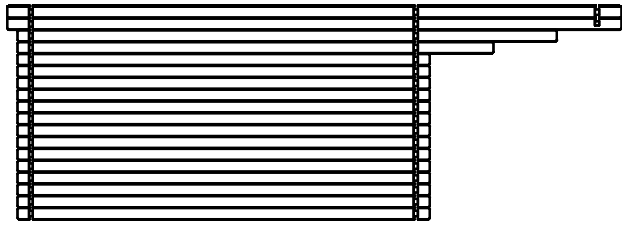

RIGHT VIEW

(D)

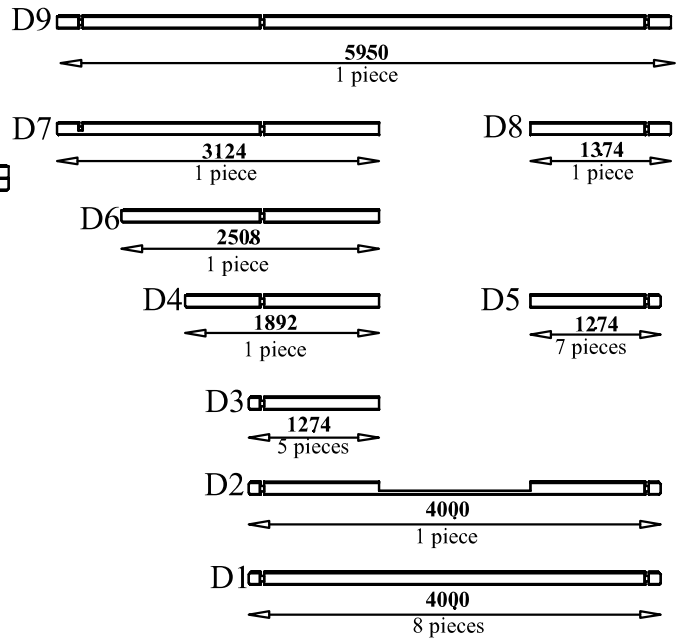
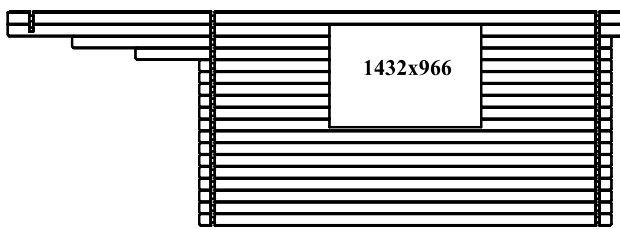

PACKAGE NR.:

MNFCT. ORDER NR.:

CONTROL 1
SIGNATURE

CONTROL 2
SIGNATURE

PAGE/PAGES: **4/8**

BUILDING CODE

TORSTEN

WALL LOG (mm): 58

SIZE (mm): 5950x4000

FRONT VIEW

(A)

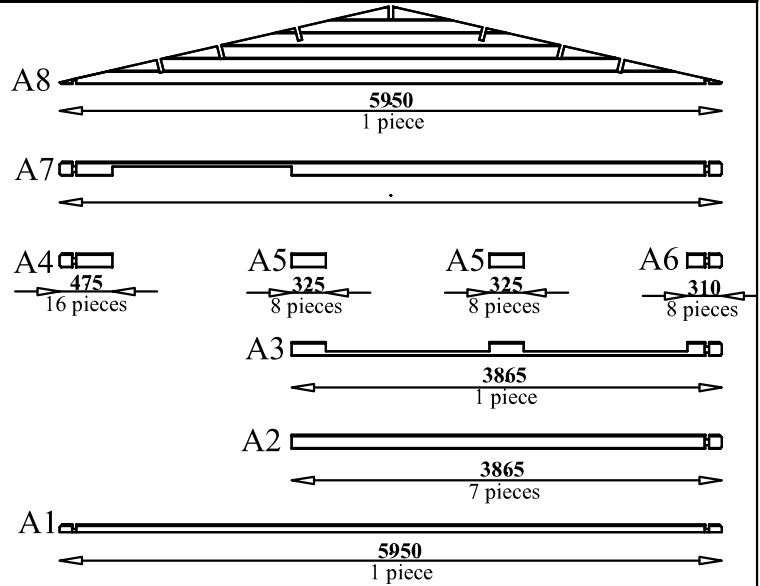
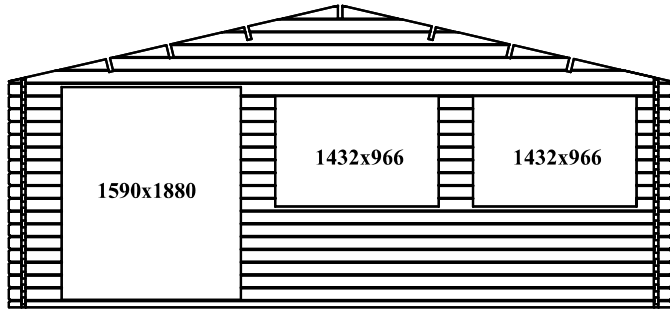

BACK VIEW

(B)

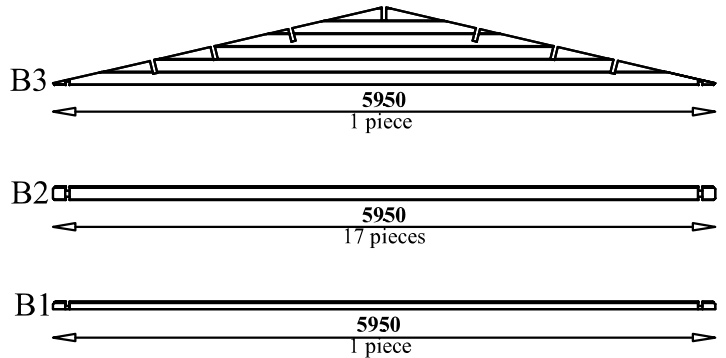
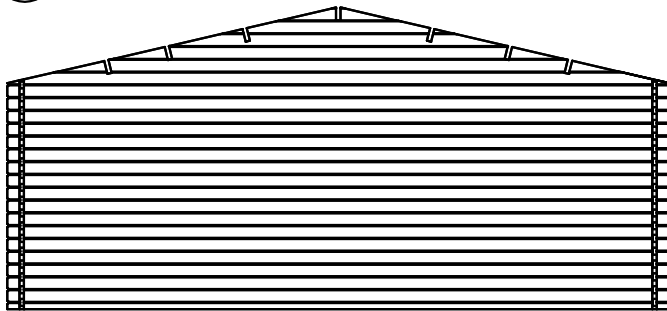

TERRACE VIEW

(E)

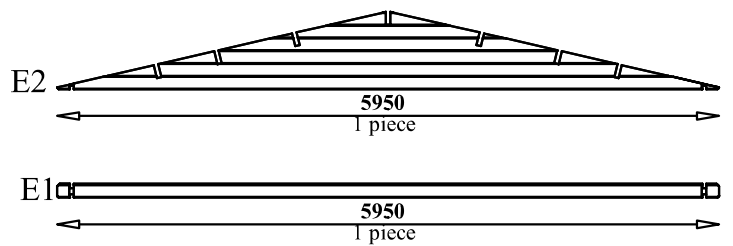
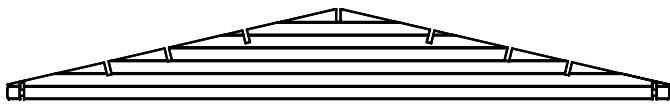

PACKAGE NR.:

MNFCT. ORDER NR.:

CONTROL 1

CONTROL 2

SIGNATURE

SIGNATURE

PAGE/PAGES: **3/8**

BUILDING CODE **TORSTEN**

WALL LOG (mm): 58

SIZE (mm): 5950x4000

ISOMETRIC VIEW



TOP VIEW

A-FRONT
B-BACK
C-LEFT
D-RIGHT
E-TERRACE

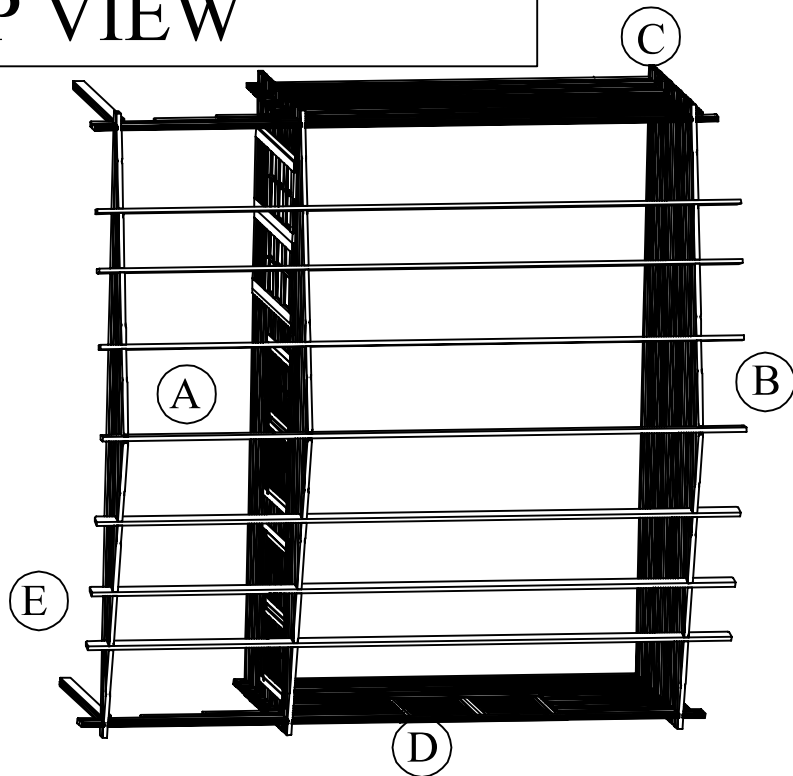

PACKAGE NR.:

MNFCT. ORDER NR.:

CONTROL 1
SIGNATURE

CONTROL 2
SIGNATURE

PAGE/PAGES: **2/8**

Always keep the package number saved! Without package number their is no guarantee.:

Package number:

WALL LOG (mm): 58

BUILDING CODE

TORSTEN

SIZE (mm): 5950x4000

COMPONENT SPECIFICATION

NUMBER	COMPONENT FUNCTION	COMPONENT CODE	VIEW	SIDE VIEW	DIMENSIONS (mm)			QUANTITY (psc.)
					LENGHT	WIDTH	THICKNESS	
1	Wall board	A2			3865	115	58	7
2	Wall board	A3			3865	115	58	1
3	Wall board	A4			475	115	58	16
4	Wall board	A5			325	115	58	16
5	Wall board	A6			310	115	58	8
6	Wall board	A7			5950	115	58	1
7	Wall board	B2, E1			5950	115	58	18
8	Wall board	C1, D1			4000	115	58	22
9	Wall board	C2			4618	115	58	1
10	Wall board	C3			5234	115	58	1
11	Wall board	C4			5950	115	58	1
12	Wall board	C5, D9			5950	115	58	2
13	Wall board	D2			4000	115	58	1
14	Wall board	D3			1274	115	58	5
15	Wall board	D4			1892	115	58	1
16	Wall board	D5			1274	115	58	7
17	Wall board	D6			2508	115	58	1
18	Wall board	D7			3124	115	58	1
19	Wall board	D8			1374	115	58	1
20	Wall board	A1, B1			5950	60	58	2
21	Wall board	A8, B3, E2		5950		58	3	
22	Window				1432	966		3
23	Door				1590	1880		1
24	Roof board				3150	110	19	110
25	Fascia board				3200/3200/3200	120/100/100	16/16/16	4/4/4
26	Roof cover fixture				3800	50	16	2
27	Roof cover fixture							
28	Beam				5950	125	55	5
29	Diamond							2
30	Column				1840	100	90	2
31	Partition of door				840	28	16	4
32	Partition of door				620	28	16	4
33	Partition of window				760	28	16	6
34	Partition of window				570	28	16	12
35	Beam of roof				5950	40	40	2
36								
37								
38								
39								
40								
41								
42								
43								
44								
45								

PACKAGE NR.:

MNFCT. ORDER NR.:

CONTROL 1

CONTROL 2

PAGE/PAGES:

1/8

SIGNATURE

SIGNATURE