

BUILDING CODE **Wigan**

WALL LOG (mm): 58

SIZE (mm): 5400x5400  
+200

## ISOMETRIC ROOF'S CONSTRUCTION

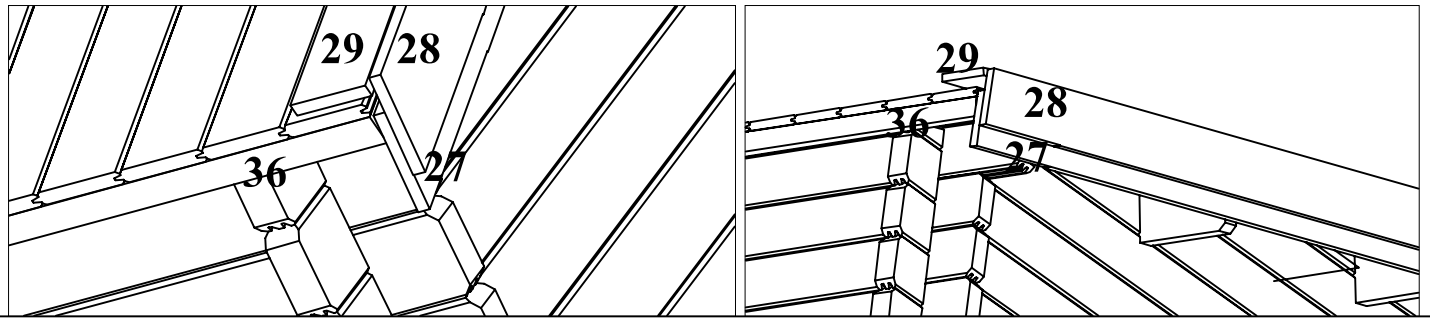

27	Roof cover fixture			2930	120	16	4
28	Roof cover fixture			2930	100	16	4
29	Roof cover fixture			2950	100	16	4
36	Beam			3915	40	40	4

## ISOMETRIC DOOR'S CONSTRUCTION

1st step

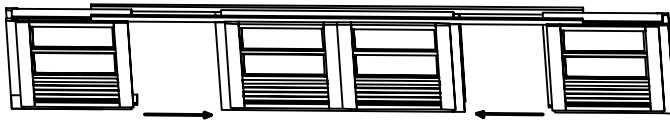

2nd step

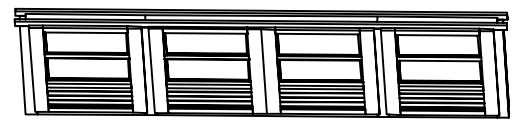

## ISOMETRIC CONSTRUCTION

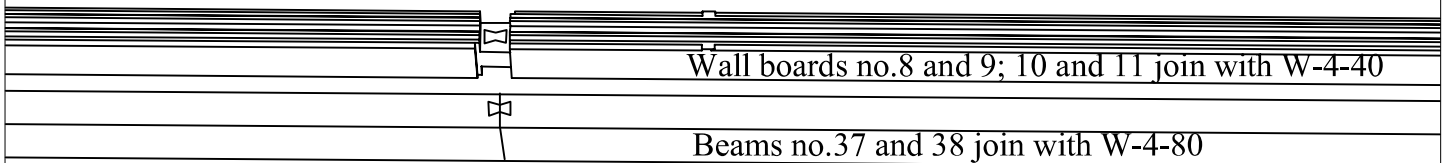

## ISOMETRIC TERRACE'S CONSTRUCTION

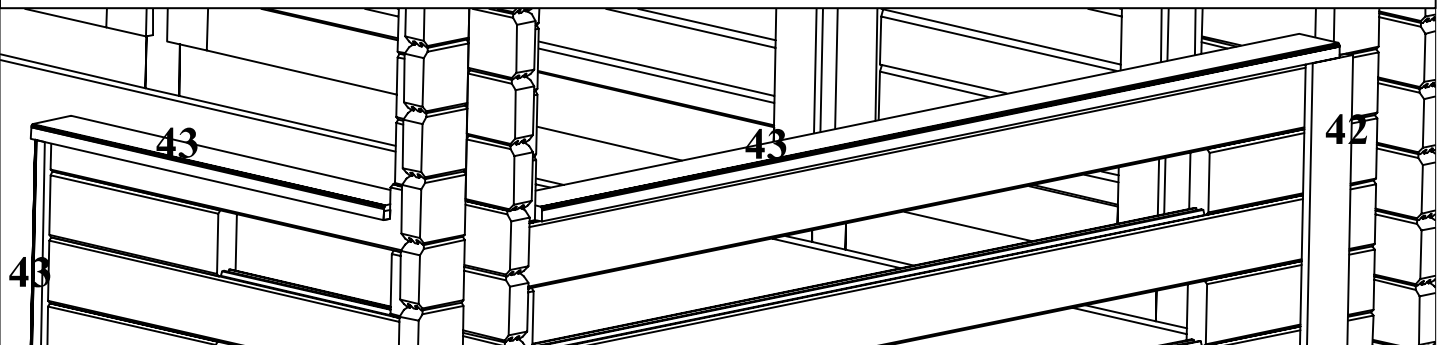

42	H profile			570	100	100	2
43	Amrest			1972/1245/585	100	26	2/2/2

PACKAGE NR.:

MNFCT. ORDER NR.:

CONTROL 1

CONTROL 2

PAGE/PAGES:

**8/8**

SIGNATURE

SIGNATURE

BUILDING CODE **Wigan**

WALL LOG (mm): 58

SIZE (mm): 5400x5400  
+200

## HEIGHT VIEW

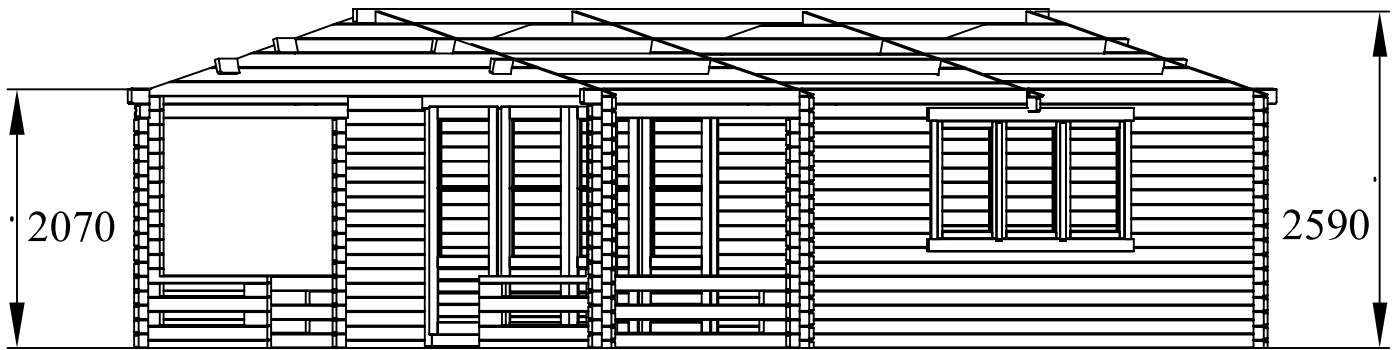

## PEDESTAL VIEW

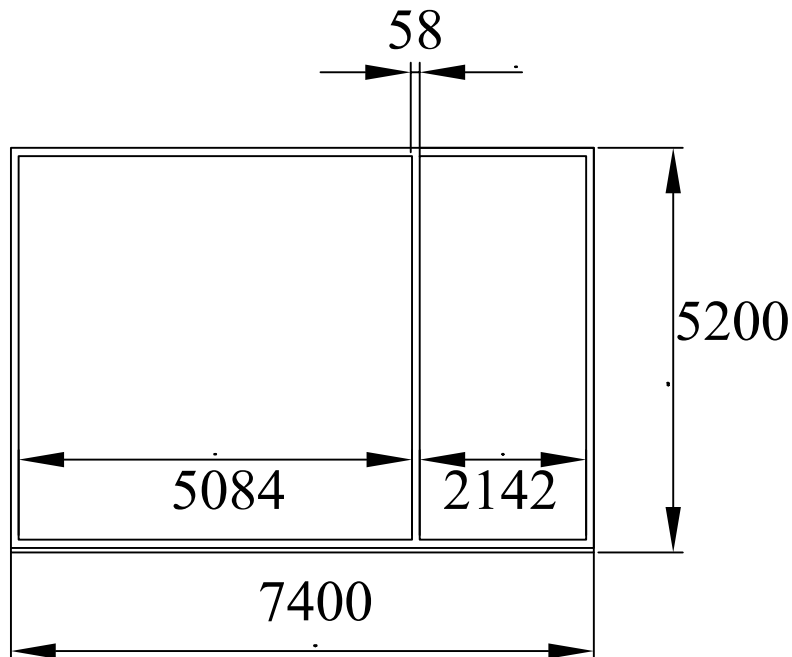

PACKAGE NR.:

MNFCT. ORDER NR.:

**CONTROL 1**  
SIGNATURE

**CONTROL 2**  
SIGNATURE

PAGE/PAGES: **7/8**

BUILDING CODE **Wigan**

WALL LOG (mm): 58

SIZE (mm): 5400x5400  
+200

## CONSTRUCTION 3

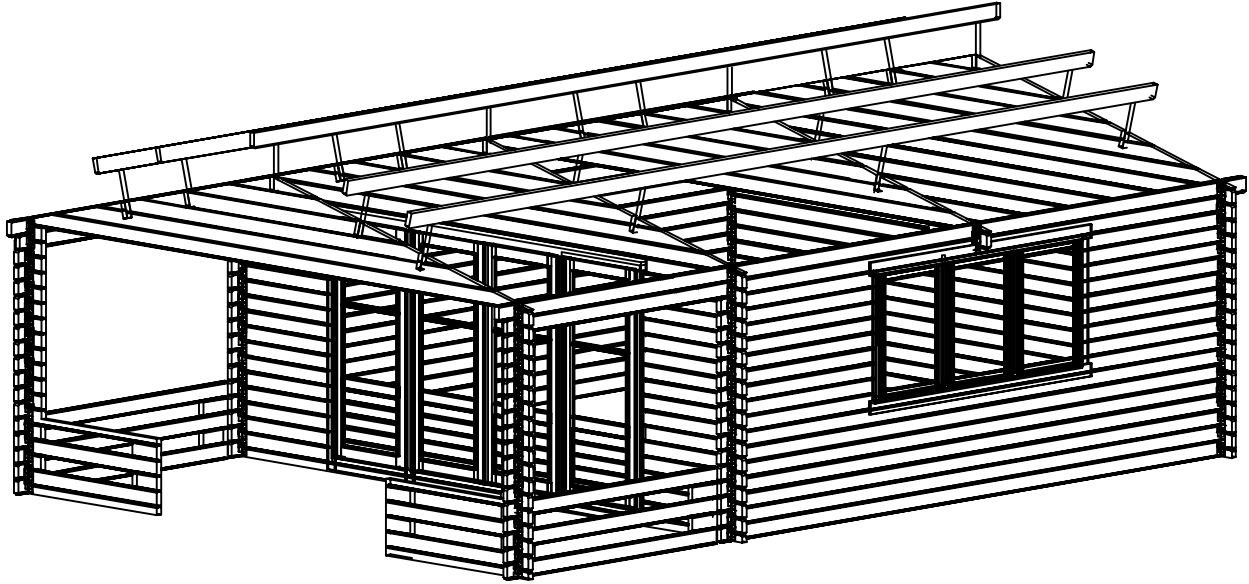

## CONSTRUCTION 4

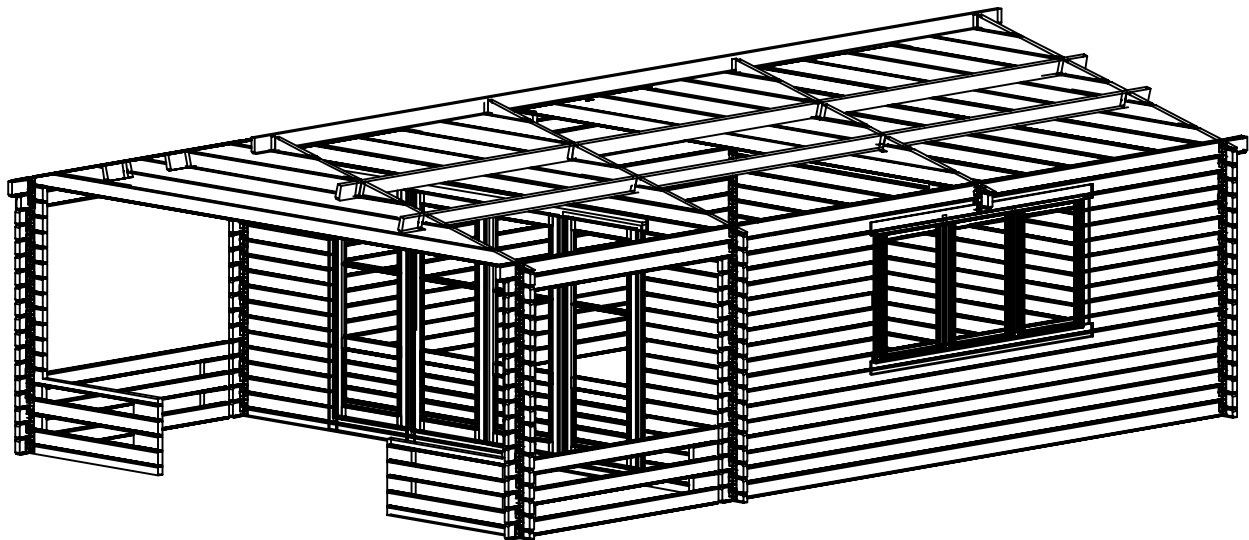

PACKAGE NR.:

MNFCT. ORDER NR.:

**CONTROL 1**

**CONTROL 2**

PAGE/PAGES: **6/8**

SIGNATURE

SIGNATURE

BUILDING CODE **Wigan**

WALL LOG (mm): 58

SIZE (mm): 5400x5400  
+200

## CONSTRUCTION 1

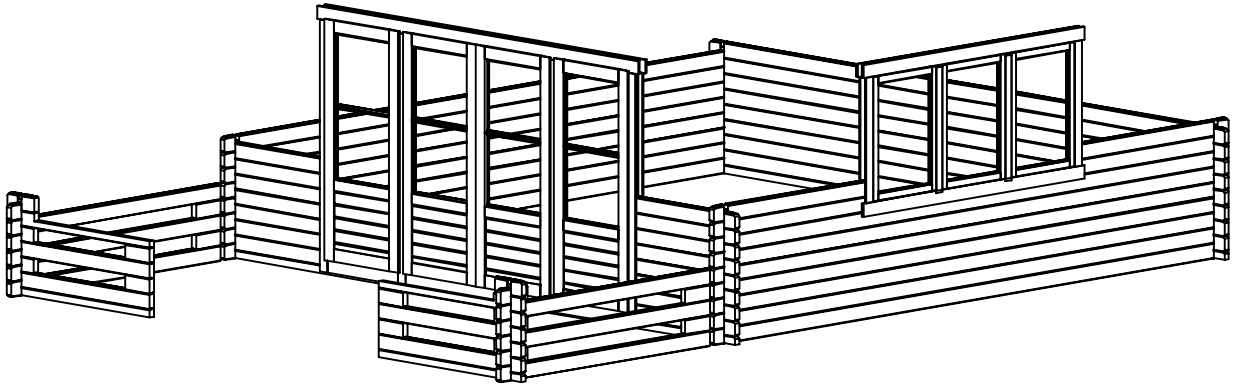

## CONSTRUCTION 2

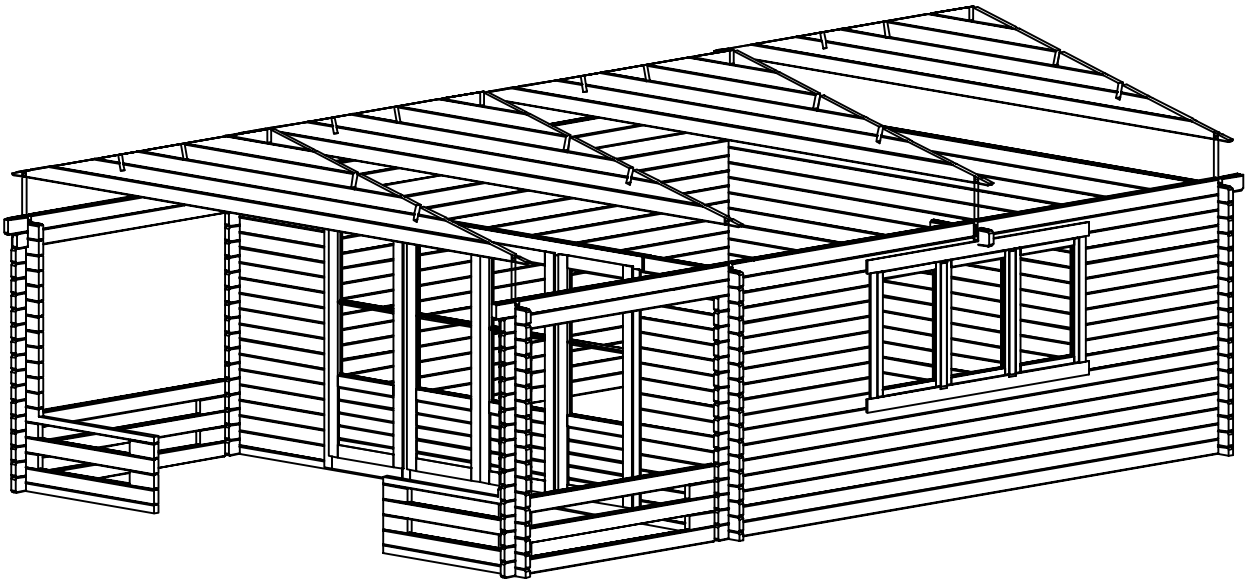

PACKAGE NR.:

MNFCT. ORDER NR.:

**CONTROL 1**

**CONTROL 2**

PAGE/PAGES: **5/8**

SIGNATURE

SIGNATURE

BUILDING CODE **Wigan**

WALL LOG (mm): 58

SIZE (mm): 5400x5400  
+200

# LEFT VIEW

(C)

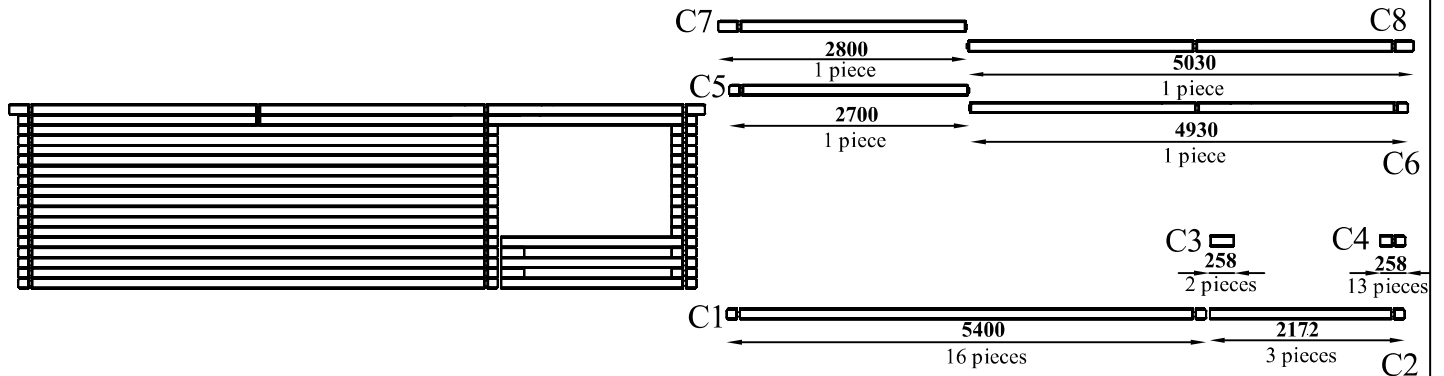

# RIGHT VIEW

(D)

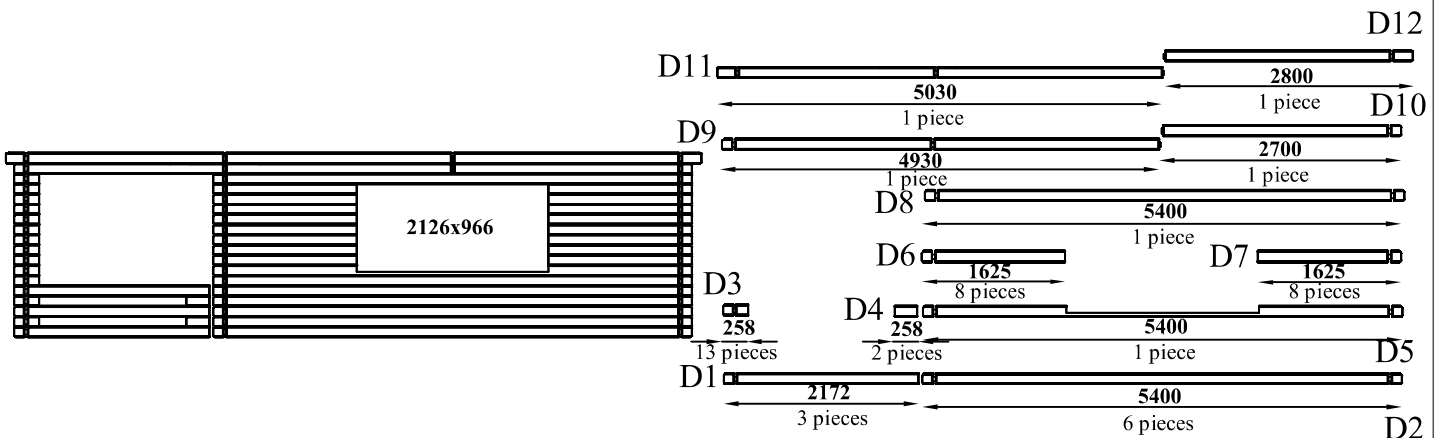

PACKAGE NR.:

MNFCT. ORDER NR.:

CONTROL 1

CONTROL 2

PAGE/PAGES:

**4/8**

SIGNATURE

SIGNATURE

BUILDING CODE **Wigan**

WALL LOG (mm): 58

SIZE (mm): 5400x5400  
+200

# TERACE VIEW

(E)

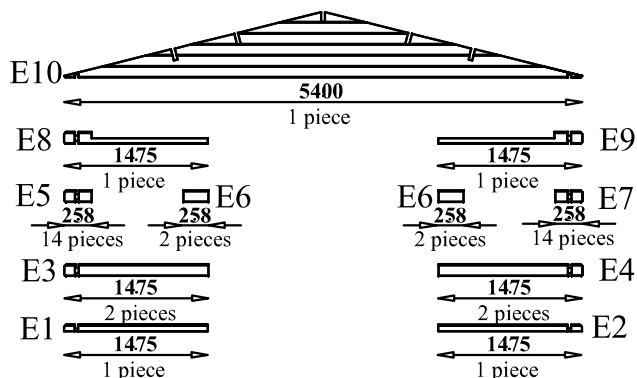
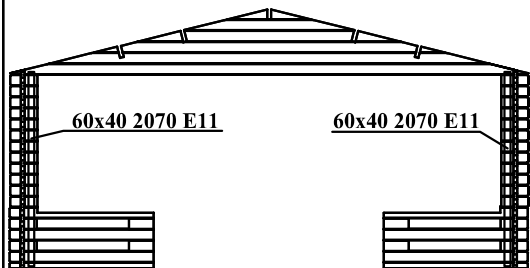

# FRONT VIEW

(A)

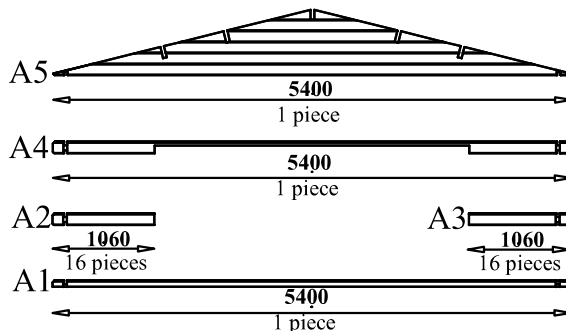
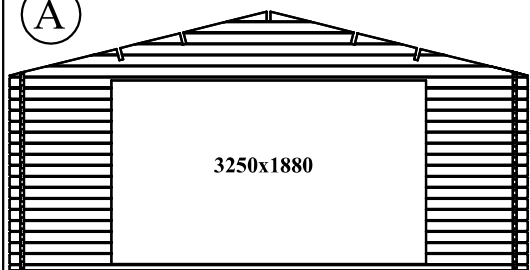

# INSIDE VIEW

(F)

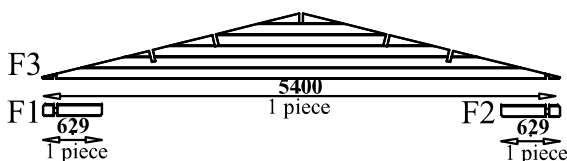

# BACK VIEW

(B)

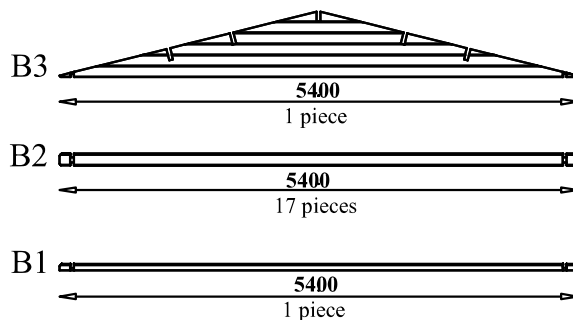
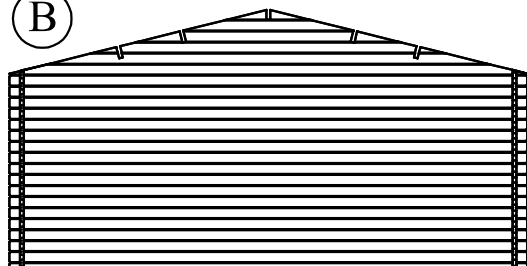

PACKAGE NR.:

MNFCT. ORDER NR.:

CONTROL 1  
SIGNATURE

CONTROL 2  
SIGNATURE

PAGE/PAGES: **3/8**

BUILDING CODE **Wigan**

WALL LOG (mm): 58

SIZE (mm): 5400x5400  
+200

## ISOMETRIC VIEW



## TOP VIEW

A-FRONT  
B-BACK  
C-LEFT  
D-RIGHT  
E-TERACE

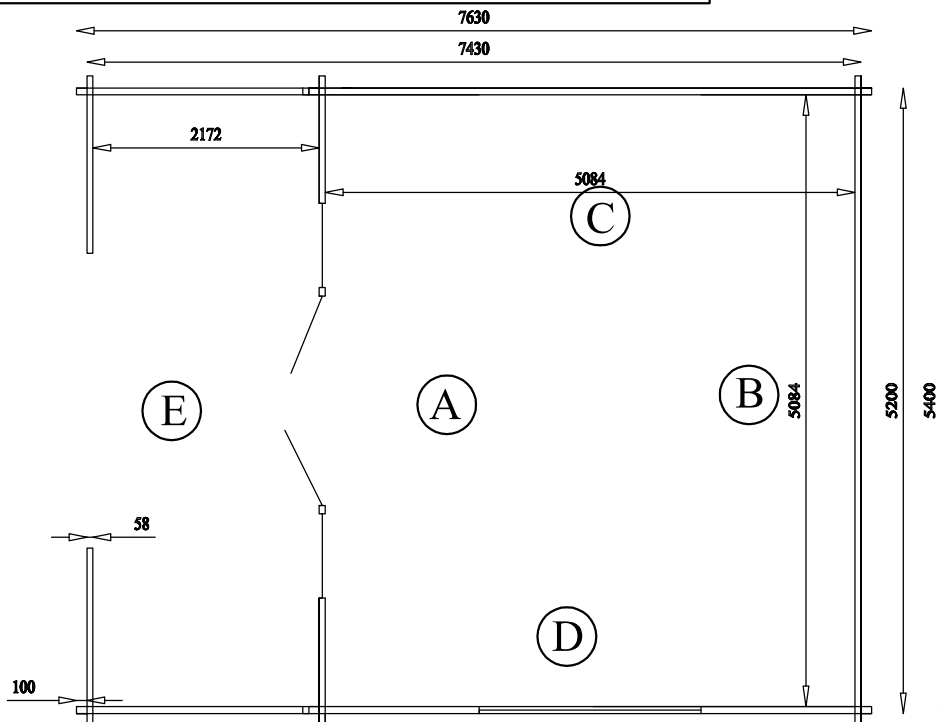

PACKAGE NR.:

MNFCT. ORDER NR.:

CONTROL 1

CONTROL 2

PAGE/PAGES: **2/8**

SIGNATURE

SIGNATURE

Always keep the package number saved! Without package number their is no guarantee.:

Package number:

WALL LOG (mm): 58

BUILDING CODE **Wigan**

SIZE (mm): 5400x5400  
+200

# COMPONENT SPECIFICATION

NUMBER	COMPONENT FUNCTION	COMPONENT CODE	VIEW	SIDE VIEW	DIMENSIONS (mm)			QUANTITY (psc.)
					LENGHT	WIDTH	THICKNESS	
1	Wall board	A2			1060	115	58	16
2	Wall board	A3			1060	115	58	16
3	Wall board	A4			5400	115	58	1
4	Wall board	B2, C1, D2			5400	115	58	39
5	Wall board	C2, D1			2172	115	58	6
6	Wall board	C3, D4, E6			258	115	58	8
7	Wall board	C4, D3, E5, E7			258	115	58	54
8	Wall board	C5, D10			2700	115	58	2
9	Wall board	C6, D9			4930	115	58	2
10	Wall board	C7, D12			2800	115	58	2
11	Wall board	C8, D11			5030	115	58	2
12	Wall board	D5			5400	115	58	1
13	Wall board	D6			1625	115	58	8
14	Wall board	D7			1625	115	58	8
15	Wall board	D8			5400	115	58	1
16	Wall board	E3			1475	115	58	2
17	Wall board	E4			1475	115	58	2
18	Wall board	E8			1475	115	58	1
19	Wall board	E9			1475	115	58	1
20	Wall board	F1, F2			629	115	58	2
21	Wall board	A1, B1			5400	55	58	2
22	Wall board	E1, E2			1475	55	58	2
23	Wall board	A5, B3, E10, F3			5400		58	4
24	Roof board				2880	110	19	144
25	Window				2126	966		1
26	Block of doors				3250	1880		1
27	Roof cover fixture				2930	120	16	4
28	Roof cover fixture				2930	100	16	4
29	Roof cover fixture				2950	100	16	4
30	Rim				3915	42	16	4
31	Rim of door				3377	100	16	2
32	Partition of door				1220	28	16	4
33	Partition of door				620	28	16	8
34	Partition of window				760	28	16	3
35	Partition of window				570	28	16	6
36	Beam				3915	40	40	4
37	Beam				5030	125	55	5
38	Beam				2800	125	55	5
39	Junction of wood				80	W-4-80		5
40	Junction of wood				40	W-4-40		4
42	H profile				570	100	100	2
43	Amrest				1972/1245/585	100	26	2/2/2
44	Diamond							2
45	Beam	E11			2070	60	40	2
46								
47								
48								
49								
50								
51								
52								
53								
54								
55								
56								

PACKAGE NR.:

MNFCT. ORDER NR.:

CONTROL 1

CONTROL 2

PAGE/PAGES:

**1/8**

SIGNATURE

SIGNATURE